



2009 RETAIL CATALOG

1964-1973 MUSTANG PARTS

We offer quality parts from the top names in the industry



Scott Drake Guarantee Complete **100%** Satisfaction



Whether you are restoring, customizing or enhancing the performance of your vehicle, Scott Drake Enterprises is dedicated to giving you the world's finest parts. For over 25 years, our engineering techniques have offered unrivaled fit, performance and durability under daily conditions. Everyone at Scott Drake Enterprises strives for your complete satisfaction. If you are not happy with this product, for any reason, simply return it to Scott Drake Enterprises within 30 days of purchase* and we will replace it - no questions asked. We stand behind our products one hundred percent, so you can sit behind the wheel with pride.

*Product must be undamaged, in resalable condition.

The Ford Trademark Licensing Program

All the parts represented with the O.L.P. logo are reproduced to the rigid quality standards and regulations of the Ford Motor Company. Working close with Ford and maintaining a strong relationship assures you the highest quality, most accurate reproductions.

Look for the trademark licensing sticker on trademarked products, because with it, you are assured quality and support.



Table of Contents

Accessories	4
Audio	9
Brakes	11
Bumpers	18
Convertible	20
Cooling	23
Decals & Striping	27
Door Parts	33
Electrical & Lighting	43
Emblems	55
Engine	59
Exhaust System	69
Fuel System	71
Grille	76
Hardware	78
Heater & A/C	84
Interior & Upholstery	89
Keys, Locks, & Latches	120
Literature	123
Mirrors	127
Molding	129
Paint, Tools, & Resto. Supplies	131
Rubber & Weather Stripping	135
Sheet Metal & Body Parts	140
Steering	151
Suspension	157
Transmission & Drivetrain.....	162
Trunk Compartment	171
Wheels	174
Windows	177
Wipers	178

© Copyright 2008 Scott Drake Enterprises Inc.

This entire catalog, photographs, line drawings, artwork and text is copyrighted.

Use of said material is strictly prohibited without written consent. Violators will be prosecuted to the fullest extent of the law.

Reproduction of this catalog in any form is a violation of the law.

We are not responsible for typographical errors.

ACCESSORIES

EXTERIOR

BUMPER STICKER



Novelty "Car rivalry" bumper stickers.

Bumper Sticker

- You drive a Chevy! Ha! Ha!BS-64
- You drive a Mopar! Ha! Ha!BS-65
- I'd rather eat worms than drive a Chevy!BS-67
- I'd Rather Eat Worms Than Drive A Mopar! BS-68
- Friends Don't Let Friends Drive Chevys.BS-69
- Friends Don't Let Friends Drive Mopars.BS-71
- Carroll Shelby Is Alive & Well & Living Under The Hood!
..... BS-73
- My Other Car Is A Classic MustangBS-74

CAR COVER



Our light duty car cover is ideal for short term use, or inside for dust prevention. Our heavy duty and premium covers each offer 3 layers of protection with the middle layer made from Aprta®, a revolutionary new material from Amoco that is extremely water resistant yet breathable to allow condensation to escape. Made in the U.S.A.

Car Cover
64-73 Premium (blue)CC-1
64-73 Heavy duty (gray)CC-2
64-73 Light duty (tan)CC-3

CAR COVER ANTENNA GROMMET



This neat little grommet snaps together and prevents the car cover from tearing at the antenna.

Car Cover Antenna Grommet

- White nylonCC-AG

CAR COVER CABLE WITH LOCK



Fits all car covers. Durable, multi-strand cable with padlock.

Car Cover Cable With Lock

- CC-CL

FENDER COVER

* Features brilliant three color design, anti-roll tool dam, soft rubberized backing to help prevent scratches and slipping. A small price to pay for protecting costly paint jobs.

Fender Cover



- ACC-300

HEADLIGHT ASSEMBLY GILL TRIM



Plastic injection molded. This is an accessory item available in the mid sixties.

Headlight Assembly Gill Trim

- 64-66 ChromeACC-610-C
- 64-66 Gold ACC-610-G

FORD MUSTANG LICENSE PLATE FRAME



A classic style frame made with sturdy die cast zinc. Chrome plated with blue background and white painted letters. Features the Ford script logo.

Limited Supply!

License Plate Frame, Ford Mustang

- 1964*C4ZZ-13409
- 1965*C5ZZ-13409
- 1966*C6ZZ-13409
- 1967*C7ZZ-13409
- 1968*C8ZZ-13409
- 1969*C9ZZ-13409
- 1970*D0ZZ-13409
- 1971*D1ZZ-13409
- 1972*D2ZZ-13409
- 1973*D3ZZ-13409

PONY MUSTANG LICENSE PLATE FRAME



A classic style frame made with sturdy die cast zinc. Chrome plated with blue background and white painted letters. Features the Running horse logo. Sold in a set of two.

Limited Supply!

License Plate Frame, Pony Mustang

- 1964 1/2*C4ZZ-13409-P
- 1965*C5ZZ-13409-P
- 1966*C6ZZ-13409-P
- 1967*C7ZZ-13409-P
- 1968*C8ZZ-13409-P
- 1969*C9ZZ-13409-P
- 1970*D0ZZ-13409-P
- 1971*D1ZZ-13409-P
- 1972*D2ZZ-13409-P
- 1973*D3ZZ-13409-P

COBRA LICENSE PLATE FRAME



A classic style frame made with sturdy die cast zinc. Chrome plated with blue background and white painted letters.

License Plate Frame, Cobra

- 64-73 * S1MS-13409

LICENSE PLATE INSERT



Stamped embossed aluminum. Multi-colored design. 12x6-inch.

License Plate Insert

- Ford Script* ACC-150

- Mustang Emblem* ACC-151

- Ford Script, Horse* ACC-152

TIRE PRESSURE GAUGE



Quality tire pressure gauge. Chrome plated with black painted rear case. 0 - 60 pounds per inch. Convenient reset button, each is packaged in hinged plastic storage case. All have white face with black numbers, letters and colored logo.

Tire Pressure Gauge

- Shelby CS logo* TG-1
- Mustang* TG-2
- Cobra* TG-3
- BOSS 302* TG-4
- Shelby Snake TG-5

LUGGAGE RACK



Solid rust resistant stainless steel construction. Copy of an original Ford

accessory that is functional and beautifies at the same time.

Luggage Rack

64-68CSZZ-6555100-F

FUN STUFF

CARDBOARD MODEL



Back again. This cardboard model of a yellow mustang is easy to assemble.

Perfect for car shows. Holds a burger & fries or other promo items.

Cardboard Model

1965*ACC-2716

CLOCK



These clocks are outstanding. Full color designs and quartz movement. Battery operated (batteries not included).

Clock



Disc brake shaped alarm clock* 12189



Mustang clock/calculator* 19591



12" square w/ running horse logo* ACC-10109



Ford Racing, neon, 14" ACC-840350



Ford oval on white face, 10" CL-FORD

MUSTANG COOKIES



Locally baked. Classic cookies baked in the shape of Mustangs and Thunderbirds. Premium

flavor and taste made with all natural flavors, low sodium and low fat. Very attractive packaging, make great stocking stuffers and gifts.

Cookies, Mustang

Small box 14954

COUNTER STOOL



This padded shop stool is made with durable heavy duty vinyl, polished chrome legs, and features the Scott Drake Logo or Mustang logo. Individually boxed. Some assembly is required.

Counter Stool



Mustang logo* ACC-400

MUSTANG MAGNETIC SIGN



"Look, But Please Don't Touch.." Car Show Signs. 3" x 5.25"

Magnetic Sign, Mustang



Classic Mustang* MM-1



Generic, eyes & hand MM-2



Generic, w/ cars MM-3



Shelby* MM-4



Generic, mob lingo MM-5

MUSTANG PARTS TAG



Vintage style "mustang" parts tags with wire.

Parts Tag, Mustang

w/ wire, bundles of 100* ACC-200

PEDAL CAR



The Legend is Reborn... This Mustang Pedal Car is the definitive revival of the '65 AMF Mustang. Built using the original tooling and brought back to the public to celebrate its 40th anniversary. This reissue of the Mustang Pedal Car is authentic in every way. It features all-steel construction, powder-coat finish, adjustable rubber pedals, clear windshield, chrome accents, rubber tires and authentic 1965 markings. Each car measures approximately 40" L x 14" W x 15" H and ships in its own box. Also available: Fire engine and Shelby GT350.

Pedal Car



65: Red* ACC-PC-RED



65: Blue* ACC-PC-BLUE



65: GT 350 white* ACC-PC-SHELBY



Red fire truck* ACC-PC-FIRE

HATS

HAT



These high quality embroidered hats make the perfect gift!

Hat



Shelby 85th Birthday - Limited Supply* HAT-85TH B-DAY



Shelby Terlingua* HAT-TERLINGUA



Bone & black, running horse HAT-183-BONE



Black, running horse & tri-bar* HAT-197-BLACK

WE PROUDLY FEATURE AUTHENTIC MUSTANG REPRODUCTIONS FROM SCOTT DRAKE ENTERPRISES!



Hat

-  Pink, running horse & tri-bar*
HAT-197-PINK
-  Red Flames, Ford logo*
HAT-F-BK/RF
-  Silver blue flames, Ford logo*
HAT-F-BK/SF
-  Yellow red flames, Ford logo*
HAT-F-BK/YF
-  Black & tan, Ford logo*
HAT-F-BLK
-  Blue & khaki, running horse*
HAT-M-B/K
-  Black & silver, running horse*
HAT-M-BK/SIL
-  Black & tan, running horse*
HAT-M-BLK
-  Black & tan, Ford logo*
HAT-R-B/T
-  Black, Ford logo*
HAT-R-BLK
-  Visor, black w/ red/orange flames, Ford logo*
VISOR-F-BK/RF
-  Visor, black w/ silver/blue flames, Ford logo*
VISOR-F-BK/SF

INTERIOR

WINDSHIELD SUN SHADE

 Keep the sun's harmful rays off that new Scott Drake dash and upholstery with this easy to put up and easy to store sun shield. It is made of heavy cardboard and features a large running horse that starts out red then fades to blue. Limited Supply!

Windshield Sun Shade
64-73 *ACC-700

KEY COVERS & KEY FOBS

MUSTANG KEY FOB

* A variety of Mustang key fobs.

Key Fob, Mustang

-  64-66: w/ key blanks*
ACC-653
-  Leather, Mustang*
ACC-180
-  Image changes from 68 to 06 Mustang*
ACC-181
-  Leather, Mach 1*
ACC-182
-  30 years, Note: Limited supply*
ACC-KC768

SHIRTS & SWEATSHIRTS

MUSTANG RACE BRED & TRUE HORSES SWEATSHIRT

 Quality shirts with brilliant silkscreen designs on both front and back. 50% cotton, 50% polyester.

Sweatshirt, Mustang Race Bred And True Horses
Medium *SS-M
Large *SS-L
XL *SS-XL
XXL *SS-XXL
XXXL *SS-XXXL

MUSTANG RACE BRED & TRUE HORSES T-SHIRT

 Quality shirts with brilliant silkscreened designs on both front and back. Our sweatshirts are made of 50% cotton/50% polyester.

T-Shirt, Mustang Race Bred And True Horses
Small *TS-2S
Medium *TS-2M
Large *TS-2L
XL *TS-2XL
XXL *TS-2XXL
XXXL *TS-2XXXL

MUSTANG CLASSIC FORD T-SHIRT

 Quality shirts with brilliant silkscreened designs on both front and back. Our T-shirts are made of 100% cotton.

T-Shirt, Mustang Classic Ford
Small *TS-3S
Medium *TS-3M
Large *TS-3L
XL *TS-3XL
XXL *TS-3XXL
XXXL *TS-3XXXL

MUSTANG EVOLUTION T-SHIRT

 Hanes® comfort T with bright full color graphics. preshrunk 100% cotton.

T-Shirt, Mustang Evolution
Small *TS-E-S
Medium *TS-E-M
Large *TS-E-L
XL *TS-E-XL
XXL *TS-E-XXL
XXXL *TS-E-XXXL

65 SMOKUM GRAY T-SHIRT



A great new T-shirt for the Mustangers. This is a Hanes Beefy-T® made of 99% cotton.

Light gray with black printing. Available in all sizes. **T-Shirt, 65 Smokum Gray**

- Small * TS-SM-65-S
- Medium * TS-SM-65-M
- Large * TS-SM-65-L
- XXL * TS-SM-65-XXL
- XXXL * TS-SM-65-XXXL

67-68 SMOKUM GRAY T-SHIRT



A great new T-shirt for the Mustangers. This is a Hanes Beefy-T® made of 99% cotton. Light

gray with black printing. Available in all sizes. **T-Shirt, 67-68 Smokum Gray**

- Small * TS-SM-67-S
- Medium * TS-SM-67-M
- Large * TS-SM-67-L
- XL * TS-SM-67-XL
- XXL * TS-SM-67-XXL
- XXXL * TS-SM-67-XXXL

67-68 MUSTANG T-SHIRT



Officially licensed by Ford and made of heavy-duty, 100% cotton. This shirt

features 3 views of the 67/68 Mustang and running horse logo.

T-Shirt, 67-68 Mustang

- Large * TS-6768-L
- XL * TS-6768-XL
- XXL * TS-6768-XXL

69 MUSTANG T-SHIRT



Officially licensed by Ford and made of heavy-duty, 100% cotton. This shirt

features the '69 Mustang and tagline "It was a very good year"

T-Shirt, 69 Mustang

- Large * TS-69-L
- XL * TS-69-XL
- XXL * TS-69-XXL

AMERICAN CLASSIC T-SHIRT



Joe Blow T's are high quality, 100% cotton with great new graphic

designs. Approved by Ford Motor Company. **T-Shirt, American Classic**

- Medium * TS-CLASSIC-M

AMERICAN ROADTRIP T-SHIRT



Joe Blow T's are high quality, 100% cotton with great new graphic designs.

Approved by Ford Motor Company. **Limited sizes and supply available!**

T-Shirt, American Roadtrip

- Medium * TS-ROAD-M
- XL * TS-ROAD-XL
- XXL * TS-ROAD-XXL

BOSS 302 T-SHIRT



Joe Blow T's are high quality, 100% cotton with great new graphic designs.

Approved by Ford Motor Company. **Limited sizes and supply available!**

T-Shirt, Boss 302

- Large * TS-302-L

FEEL THE HEAT T-SHIRT



Joe Blow T's are high quality, 100% cotton with great new graphic designs.

Approved by Ford Motor Company. **Limited sizes and supply available!**

T-Shirt, Feel The Heat

- Medium * TS-HEAT-M
- XXL * TS-HEAT-XXL

MACH 1 T-SHIRT



Joe Blow T's are high quality, 100% cotton with great new graphic designs.

Approved by Ford Motor Company. **Limited sizes and supply available!**

T-Shirt, Mach 1

- Medium * TS-MACH1-M

RED W/ RED CONVERTIBLE T-SHIRT



Joe Blow T's are high quality, 100% cotton with great new graphic designs.

Approved by Ford Motor Company. Limited sizes and supply available! **Limited sizes and supply available!**

T-Shirt, Red With Red Convertible

- XXL * TS-GT-XXL

SHELBY "1962" T-SHIRT



This shirt has modern designing with vintage feel, once again proving that

Shelby is hip to the times since 1962.

T-Shirt, Shelby "1962"

- Orange, Medium [§] TS-014-OR-M
- Orange, Large [§] TS-014-OR-L
- Orange, XL [§] TS-014-OR-XL
- Orange, XXL [§] TS-014-OR-XXL
- Orange, XXXL [§] TS-014-OR-XXXL
- Dark gray, Medium [§] TS-015-GY-M
- Dark gray, Large [§] TS-015-GY-L
- Dark gray, XL [§] TS-015-GY-XL
- Dark gray, XXL [§] TS-015-GY-XXL
- Dark gray, XXXL [§] TS-015-GY-XXXL

FOX MUSTANG T-SHIRT



Officially licensed by Ford and made of heavy-duty, 100% cotton. This shirt

features 3 views of the "Fox" Mustang and the Mustang Tribar logo. **Limited sizes and supply available!**

T-Shirt, Fox Mustang

- Large * TS-FOX-L
- XL * TS-FOX-XL
- XXL * TS-FOX-XXL

THE BOSS T-SHIRT



High quality, 90% cotton with great new designs.

T-Shirt, The Boss

- Medium * TS-BOSS-M
- Large * TS-BOSS-L
- XL * TS-BOSS-XL
- XXL * TS-BOSS-XXL

WE PROUDLY FEATURE AUTHENTIC MUSTANG REPRODUCTIONS FROM SCOTT DRAKE ENTERPRISES!



SHELBY COBRA SIGNATURE T-SHIRT



This shirt is perfect for any Shelby Cobra Fan. It features the Cobra Snake with

Carroll Shelby's Signature Through the middle. Available in blue or mustard yellow.

T-Shirt, Shelby Cobra Signature

Blue, Medium ^s	TS-003-BL-M
Blue, Large ^s	TS-003-BL-L
Blue, XL ^s	TS-003-BL-XL
Blue, XXL ^s	TS-003-BL-XXL
Blue, XXXL ^s	TS-003-BL-XXXL
Mustard, Medium ^s	TS-003-M-M
Mustard, Large ^s	TS-003-M-L
Mustard, XL ^s	TS-003-M-XL
Mustard, XXL ^s	TS-003-M-XXL
Mustard, XXXL ^s	TS-003-M-XXXL

SHELBY 85TH BIRTHDAY T-SHIRT



Celebrate the birth of a racecar legend with this awesome Carroll Shelby

85th Birthday Short Sleeve T-shirt. There is a limited supply so get yours now while they are still available!

T-Shirt, Shelby 85th Birthday

White, Medium ^s	TS-012-WT-M
White, Large ^s	TS-012-WT-L
White, XL ^s	TS-012-WT-XL
White, XXL ^s	TS-012-WT-XXL
White, XXXL ^s	TS-012-WT-XXXL
Gray, Medium ^s	TS-013-GY-M
Gray, Large ^s	TS-013-GY-L
Gray, XL ^s	TS-013-GY-XL
Gray, XXL ^s	TS-013-GY-XXL
Gray, XXXL ^s	TS-013-GY-XXXL

SHELBY 85TH BIRTHDAY LONG SLEEVE T-SHIRT



Celebrate the birth of a racecar legend with this awesome Carroll Shelby

85th Birthday Long Sleeve T-shirt. There is a limited supply so get yours now while they are still available!

T-Shirt, Shelby 85th Birthday Long Sleeve

White, Medium ^s	TSL5-12-WT-M
White, Large ^s	TSL5-12-WT-L
White, XL ^s	TSL5-12-WT-XL
White, XXL ^s	TSL5-12-WT-XXL
Gray, Medium ^s	TSL5-13-GY-M
Gray, Large ^s	TSL5-13-GY-L
Gray, XL ^s	TSL5-13-GY-XL
Gray, XXL ^s	TSL5-13-GY-XXL

SHELBY TERLINGUA T-SHIRT



This black shirt is very comfortable and features the Yellow Terlingua Rabbit on the front.

T-Shirt, Shelby Terlingua

Medium ^s	TS-011-M
Large ^s	TS-011-L
XL ^s	TS-011-XL
XXL ^s	TS-011-XXL
XXXL ^s	TS-011-XXXL

TERLINGUA LONG SLEEVE T-SHIRT



This black shirt is very comfortable and features the Yellow Terlingua Rabbit on the front.

T-Shirt, Shelby Terlingua Long Sleeve

Medium ^s	TSL5-01-M
Large ^s	TSL5-01-L
XL ^s	TSL5-01-XL
XXL ^s	TSL5-01-XXL

WOMENS FAST GIRL T-SHIRT



Quality shirts with brilliant silkscreened designs on both front and back. Our T-shirts are made of 100% cotton.

T-Shirt, Womens Fast Girl

Small*	TS-S-GIRL
Medium*	TS-M-GIRL
Large*	TS-L-GIRL

WOMENS PURE BRED GIRL T-SHIRT



We haven't forgotten the ladies. This 100% cotton t-shirt will be perfect for those hot car shows coming up.

T-Shirt, Womens Pure Bred Girl

Small*	TS-S-PB
Medium*	TS-M-PB
Large*	TS-L-PB

WOMENS SHELBY GIRL PINK T-SHIRT



This Shelby Girl short sleeve v-neck shirt looks great. Featuring a flower design, and a Cobra Snake, it is perfect

for any girl wanting to show her love for the Shelby Cobra.

T-Shirt, Womens Shelby Girl Pink

Small ^s	TS-002-PNK-S
Medium ^s	TS-002-PNK-M
Large ^s	TS-002-PNK-L
XL ^s	TS-002-PNK-XL
XXL ^s	TS-002-PNK-XXL

YOUTH/INFANT BORN 2 CRUZ T-SHIRT



Quality 100% cotton with beautiful full-color artwork. A must for every child & grandchild of a Mustang.

T-Shirt, Youth / Infant Born 2 Cruz

Snap Shirt, 12 mo*	B2C-12M
Snap Shirt, 24 mo*	B2C-24M
Toddler, 2T*	B2C-2T
Toddler, 4T*	B2C-4T
Toddler, 6/8T*	B2C-6/8T
Toddler, 10/12T*	B2C-10/12T
Toddler, 14/16T*	B2C-14/16T

YOUTH GROW UP FORD T-SHIRT



Classic "When I grow up I'm gonna drive a Ford" logo on a quality Tee Shirt

T-Shirt, Youth Grow Up Ford

Kids, 2T*	TS-2T
Kids, 4T*	TS-4T
Kids, 6/8T*	TS-68T
Kids, 10/12T*	TS-1012T

YOUTH SHELBY KID PEDAL CART T-SHIRT



Every Shelby parent needs to pass on the Shelby tradition to their children and this shirt is

a great way to start. It features a Shelby Pedal car, and the Cobra Snake.

T-Shirt, Youth Shelby Kid Pedal Car

Blue, Extra Small (2-4) ^s	TS-006-BL-XS
Blue, Small (6-8) ^s	TS-006-BL-S
Blue, Medium (10-12) ^s	TS-006-BL-M
Blue, Large (14-16) ^s	TS-006-BL-L
Pink, Extra Small (2-4) ^s	TS-006-PNK-XS
Pink, Small (6-8) ^s	TS-006-PNK-S
Pink, Medium (10-12) ^s	TS-006-PNK-M
Pink, Large (12-14) ^s	TS-006-PNK-L

WATCHES

WATCH



* These are sure to become collectors items. All Automotive Timepiece watches carry a limited 3 year warranty Watch



Men's, Mustang calendar*
10041



Men's, Cobra calendar*
13813



Women's, 100th anniversary
limited supply
10381

AUDIO & ELECTRONICS

ANTENNAS

ANTENNA

Each antenna offers excellent quality and supreme performance.

Antenna



64-68: Reproduction, exact copy
CSZZ-18813-B



68-73: Not exact copy, similar to orig., rectangular base
C8ZZ-18813-AR



64-73: Universal power antenna
S-698



65-70: OEM Shelby
CSAZ-18813-J

ANTENNA BASE GROMMET



High quality compression molded neoprene rubber. Fits round base antennas.

Antenna Base Grommet

64-67CSZZ-18A813-A

ANTENNA LEAD WIRE



Connects antenna to radio.

Antenna Lead Wire

69-70 34" lengthC9ZZ-18812-A

RADIOS

USA-1 RADIO



From Scott Drake and Custom Autosound, our

USA-1 radio fits in the original dash without cutting, and features an attractive bezel with raised Mustang script. Features include: AM/FM, auto reverse cassette, and an auxiliary input for iPod, MP3, satellite radios, etc.

Radio, USA-1

64-66 Black*USA-1-5B
64-66 Chrome*USA-1-5C
67-73 Black*USA-1-7B
67-73 Chrome*USA-1-7C

USA-2 RADIO



From Scott Drake and Custom Autosound,

our USA-2 radio fits in the original dash without cutting, and features an attractive bezel with raised Mustang script. All the same features as our USA-1 except no cassette.

Radio, USA-2

64-66 Black*USA-2-5B
64-66 Chrome*USA-2-5C
67-73 Chrome*USA-2-7C

USA-5 RADIO



From Scott Drake and Custom Autosound,

our USA-5 radio fits in the original dash without cutting, and features an attractive bezel with raised Mustang script. Features include: AM/FM, and auto reverse cassette. Other USA-5 features include: power antenna lead, AM/FM LO/DX selector, and an upgraded AM/FM tuner for optimum reception.

Radio, USA-5

64-66 Black*USA-5-5B
64-66 Chrome*USA-5-5C
67-73 Black*USA-5-7B
67-73 Chrome*USA-5-7C

USA-6 RADIO



From Scott Drake and Custom Autosound,

our USA-6 radio fits in the original dash without cutting, and features an attractive bezel with raised Mustang script. All the same features as USA-5 except this radio features auxiliary input for iPod, MP3, satellite radios, etc. and no cassette.

Radio, USA-6

64-66 Chrome*USA-6-5C
67-73 Chrome*USA-6-7C

USA-66 RADIO



If you want an authentic looking radio, then the USA-

66 is for you. Designed to look exactly like the 66 Mustang AM-FM option, this radio gives you a direct connection to today's audio options. Features manual tuning AM/FM stereo PLL tuner with auxiliary input for iPod, MP3, satellite radio etc., and will also control an optional 10 disc CD changer (USA-CD10) from the buttons on the radio (No FM Modulation). Push-buttons operate CD & Aux input functions (no radio station pre-sets). Comes with removable labels for the buttons, once you become familiar with the button features just remove the labels to get that OEM look you want.

Radio, USA-66

64-66 *USA-66

RADIO SIDE-BY-SIDE COMPARISON

	USA-1	USA-2	USA-5	USA-6	USA-66	RetroSound Radio 1	Secret Audio	KNW-600	KNW-801
AM/FM	•	•	•	•	•	•	•	•	•
Auto-Reverse Cassette	•								
Station Presets	18fm / 12AM	18fm / 12AM	18fm / 12AM	18fm / 12AM	NONE	18fm / 12AM	12fm / 6AM	18fm / 12AM	18fm / 12AM
Direct CD Controller			•	•	•				
Clock	•	•	•	•	•	•	•	•	•
Power Antenna Lead	•	•	•	•	•	•	•	•	•
4 Channel RCA Output	•	•	•	•	•	•	•	•	•
Auxiliary Audio Input (iPod, satalite, etc)	•	•		•	•	FRONT & REAR			
Wireless Remote						•	•		
Replica of '66 Mustang AM/FM Option					•				
Output Power	200 watts	200 watts	240 watts	240 watts	200 watts	240 watts	140 watts		

WE PROUDLY FEATURE AUTHENTIC MUSTANG REPRODUCTIONS FROM SCOTT DRAKE ENTERPRISES!



RETRO SOUND RADIO 1



This is a breakthrough am/fm equipped classic car radio offering flexible mounting

options with infiniMount shaft/bracket system (patent pending) for superior installation flexibility. Rear mounted USB input for MP3/WMA digital file playback from popular flash devices, no ipod needed - just use ANY Flash Drive/Thumb drive with your digital files on it. This radio also features front and rear panel auxiliary inputs for iPod, MP3, satellite radios, etc., 4 channel amplifier, RCA pre-outs and even includes an under dash bracket for custom or hide away installation options! **Vehicle specific trim bezels and metal knobs are sold separately** to allow the unit to integrate perfectly into your classic Mustang (See below)

Radio 1, RetroSound
64-73RS-6573-1

RETRO SOUND FACE PLATE & KNOBS

The face plate & knobs to finish off the Retro-Sound Radio 1 (above) with a Mustang look. **Face Plate and Knobs, RetroSound Radio 1**

64-66RS-65-FPK
67-73RS-67-FPK

SECRET AUDIO RADIO



Secretaudio is a wireless remote control hidden audio system that offers great

flexibility for mounting in any Mustang.

Radio, Secretaudio
64-73SECRETAUDIO-SS

KENWOOD 600 RADIO



A quality stereo manufactured by Kenwood. Features

include: 30 station presets, Auto-reverse cassette, Digital clock, Separate bass & treble controls, 4 speaker output with fader control, and RCA pre-out with pre-amp fader control.

Radio, Kenwood 600
64-66 Black*KEN-600C5-BK
64-66 Chrome*KEN-600C5-C
67-73 Black*KEN-600C7-BK

KENWOOD 801 RADIO



All the same features as the Kenwood 600 radio, the 801

also features direct CD Control for use with our USA-CD10 CD changer.

Radio, Kenwood 801
64-66 Black*KNW-801-5B
64-66 Chrome*KNW-801-5C
67-70 Black*KNW-801-7B
67-70 Chrome*KNW-801-7C

MISCELLANEOUS AUDIO

CD CHANGER



New! Replaces the CD60 changer. Works with USA-5 & USA-6 radios.

CD Changer
64-73 10DiscUSA-CD10

DASH PANEL REPAIR PLATE



For that hacked radio installation, this panel provides a new dashboard section for installation of a stock radio and an original look. Can be welded into position. Designed to fit under dash pad.

Dash Panel Repair Plate
65-66CSZZ-6504360-PP

RADIO BEZEL

Radio Bezel



67-68: Black/chrome, w/out console
C8ZZ-18842-AR



69-70: Black/chrome
C9ZZ-6504774-B



69-70: Walnut woodgrain
C9ZZ-6504774-F



71-73: Black/chrome
D1ZZ-18842-A

JVC AND KENWOOD RADIO KNOB



Nice replacement plastic chrome radio knobs to fit JVC or Kenwood radios.

Radio Knob, JVC and Kenwood
64-66 ChromeJVC-KNOBS

RADIO KNOB AND DIAL SET



Pressure die cast construction. Not cheap light weight plastic. Chrome plated and concourse correct. For use on original Ford radios.

Radio Knob and Dial Set
64-66C4AZ-18817/30-A
69-70C9ZZ-18817-K

IPOD STEREO ADAPTER



Allows you to listen to your Ipod through your compatible car stereo.

Stereo Adapter, Ipod
64-73 AdapterICAMKIT

USB FLASH STEREO ADAPTER



Allows for hook-up of any device with a USB port to a compatible car stereo.

Stereo Adapter, USB Flash
64-73 USBCAM-USB-FLASH

SPEAKERS

MOLDED KICK PANEL SPEAKER



Want more sound without cutting or drilling your classic Mustang? These kickpanel speaker assemblies offer a "no















modification" fit. Come fitted with Kenwood 6 1/2" 80 watt speakers, or Pioneer 6 1/2" 150 watt speakers.

Molded Kick Panel Speaker
64-66 Kenwood, 80 watt, CP/FBKMC-1
64-66 Kenwood, 80 watt, CVKMCV-1
67-68 Kenwood, 80 watt, CP/FBKMC-2
67-68 Kenwood, 80 watt, CVKMCV-2
65-66 Pioneer, 120 watt, CP/FBPIO-KMC-1
64-66 Pioneer, 120 watt, CVPIO-KMCV-1
67-68 Pioneer, 120 watt, CP/FBPIO-KMC-2
67-68 Pioneer, 120 watt, CVPIO-KMCV-2

SPEAKER

High quality speakers, ranging from stock (OEM) style to multi-cone stereo models for terrific sound quality.

Speaker

	64-66: 4x10, 160 watts, by RetroSound C5AZ-18808-RDVC
	64-66: Dash, OEM style replacement C5AZ-18808-A
	64-66: Dash, dual voice coil by Custom Autosound, 140 watts C5AZ-18808-DVC
	64-66: Dash, dual by Kenwood, 40 watts C5AZ-18808-KEN
	64-66: Dash, 3" dual cone by Custom Autosound, 60 watts C5AZ-18808-ST
	64-73: Hidden, under/behind seat, 200 watts ACC-18808-S
	64-73: Hidden, two 8" woofers,, rear seat, Custom Autosound BSD-65-C
	64-73: Package tray, 6"X9", 140 watts C5AZ-18808-PT
	65-68: Rear, 6"x9" stock replacement C5ZZ-18808-R
	66: Door, 4"x6" C6ZZ-18808-A
	67-68: 5"x7" upgrade dual coice coil by Custom Autosound, 140 watts, w/ AC C7AZ-18808-DVCA
	67-68: Dash w/out AC, Dual by Kenwood, 40 watts C7AZ-18808-KEN
	67-68: Dash, 3" dual cone by Custom Autosound, 60 watts, w/out AC only C7AZ-18808-ST
	67-73: 5x7, 100 watts, by RetroSound C7AZ-18808-RDVC
	67-68: Dash, 5"x7" upgrade dual cone OEM style replacement, stock radios only C7AZ-18808-D

Speaker

	67-68: Dash, 5"x7" co-axial, 60 watts, w/out AC C7AZ-18808-DLX
	67-68: Dash, Dual voice coil by Custom Autosound, 140 watts, w/out AC only C7AZ-18808-DVC
	69-70: Dash, Dual by Kenwood, 40 watts C9AZ-18808-KEN
	69-73: Door, 4"x6" C9ZZ-18808-A

REAR SPEAKER GRILLE



Speaker Grille, Rear

65-68C5ZZ-18798-A

DOOR SPEAKER GRILLE

Speaker Grille, Door



65-66
C6ZZ-18798-A



67-68: dlx., also fits 65-66 doors for a custom look, use C7ZN-3301 for proper installation
C7ZZ-6520956/7A



69-70: "Stereo" script
C9ZZ-18798-A



71-73
D2ZZ-18978-A

BRAKES

BRAKE CONVERSION KITS

FRONT DISC BRAKE CONVERSION KIT



Works great with our Power Brake Conversion. All new parts. No core required. These kits do not include a master cylinder.

Note: depending on year and application, a proportioning valve and/or distribution block may be required. Note: *These kits do not include instructions and should be installed by someone familiar with basic brake systems. Picture is for reference only. V8 kits include splash shields.*

Disc Brake Conversion Kit, Front

64-66	6 cyl., orig. 4 lug, single piston calipers, will not fit orig. 14"x5" rims .. DBC-6466-6
64-66	6 cyl., 5 lug, single piston calipers, will not fit orig. 14"x5" stock steel rims DBC-6466-6-5LUG
64-69	V8, four piston calipers, will not fit orig. 14"x5" stock steel rims DBC-6569
64-69	V8, single piston calipers, will not fit orig. 14"x5" stock steel rims DBC-6569-SC
65-69	V8, hi-po slotted rotors, single piston calipers, will not fit orig. 14"x5" stock steel rims DBC-6569-RACE
67-69	6 cyl., 4 lug, single piston calipers, will not fit orig. 14"x5" stock steel rims DBC-6769-6

FRONT DISC BRAKE CONVERSION KIT WITH MASTER CYLINDER



These kits includes everything necessary to completely convert a production drum-brake equipped car to factory

disc brakes, including proportioning valve and master cylinder. These will not fit standard stock rims. *Picture is for reference only.*

Disc Brake Conversion Kit with Master Cylinder, Front

64-66	V8, 4 piston, non-slotted rotors, power DBC-A120-P
64-66	6 cyl., non-power DBC-A120-4
64-66	6 cyl., dual master cyl., power, auto. DBC-A120-5
64-66	8 cyl., dual master cyl. DBC-A120-D
64-66	8 cyl. manual brakes, single reservoir master cyl., OE Design DBC-A120
65-69	Force 10 4-piston alum. calipers, slotted rotors DBC-A120-2
67-69	8 cyl. DBC-A121

(Continued on next page)

WE PROUDLY FEATURE AUTHENTIC MUSTANG REPRODUCTIONS FROM SCOTT DRAKE ENTERPRISES!



- 68-69 8 cyl. DBC-A132-1
- 68-69 Automatic DBC-A132-A
- 68-69 Manual DBC-A132-M
- 70 Cast iron single piston, power, inc. new disc brake spindles DBC-A133
- 70-73 Force 10 4-piston alum. calipers, bolts to drum brake spindles DBC-A133-3
- 70-73 Cast Iron 4 piston, manual or power brakes, bolts to drum brake spindles DBC-A133-2
- 71-73 Power DBC-A134

FORCE 10 DISC BRAKE UPGRADE KIT



This kit will upgrade your standard disc brakes to "Force 10" disc brakes. (Not a drum to disc brake conversion)

- Disc Brake Upgrade Kit, Force 10**
 64-67 DBC-A120-10

REAR DISC BRAKE CONVERSION KIT

Your classic Mustang will stop even better with a Rear Disc Brake Conversion Kit. Every kit includes full feature calipers with parking brake, splash shields, flex hoses and all the necessary hardware to install disc brakes on your 8" or 9" Ford axle.

Disc Brake Conversion Kit, Rear



- 64-73: Super duty, 31 spline rear axle DBC-A110
- 64-73: std. duty, 31 spline rear axle DBC-A110-1
- 64-73: Super duty, 28 spline rear axle DBC-A111
- 64-73: std. duty, 28 spline rear axle DBC-A111-2



- 64-73: std. rotors, 28 spline * DBC-REAR
- 64-73: Drilled & slotted rotors * DBC-REAR-RACE

* Parking brake cables sold separately

BRAKE PEDALS

BRAKE & CLUTCH PEDAL BUSHING



Made from high strength, wear resistant plastic. Four required for automatic cars, six for manual transmission cars.

- Brake And Clutch Pedal Bushing**
 64-73 B7AZ-2471-A

BRAKE & CLUTCH PEDAL SUPPORT



Complete assembly stamped construction includes pressed in bushings.

- Brake And Clutch Pedal Support**
 64-66 CSZZ-6501508-A

POWER BRAKE PEDAL



This pedal required when switching over to factory power brakes. This pedal is not required when using our power brake conversions.

- Brake Pedal, Power**
 68-69 Automatic trans DBC-A21184
 68-70 Manual trans DBC-A21185

BRAKE & CLUTCH PEDAL & PEDAL SUPPORT REBUILD KIT



This kit has everything you need to repair your clutch and brake pedal and pedal support in one easy kit. Includes 378200-K,

- CSZZ-2478-AK and 2 additional B7AZ-2471-A. **See Transmission section for Roller bearing upgrade kit.**
Rebuild Kit, Brake And Clutch Pedal And Pedal Support
 64-70 CSZZ-2478-MK

BRAKE PEDAL PAD

Made by Scott Drake with exact detail of the original. Compression molded rubber. Disc brake versions include stainless steel center trim.

Brake Pedal Pad



- 64-67: w/ power drum
 CSZZ-2457-E



- 64-67: drum, auto.
 CSZZ-2457-F



- 65-73: drum, manual
 CSZZ-2457-G



- 68-73: drum, automatic
 C60Z-2457-A

DISC BRAKE PEDAL PAD

These reproduction pads are high quality replacements for worn or missing original pads.

Brake Pedal Pad, Disc



- 65-67: disc, auto.
 CSZZ-2454-C



- 65-73: disc, manual
 CSZZ-2454-D



- 68-73: disc, auto.
 D3ZZ-2454-A

BRAKE PEDAL PAD TRIM



Replacement brake pedal pad trim.

Brake Pedal Pad Trim

- 65-67 auto. CSZZ-2A487-B
- 65-73 manual D1ZZ-2A487-B
- 68-73 auto. C60Z-2A487-A

DISC BRAKE COMPONENTS

DISC BRAKE DUST SHIELD



Stamped steel construction. Ready to install.

Brake Dust Shield, Disc

- 65-67 CSZZ-2K004/5-A
- 68-73 C90Z-2K004/5-A

DISC BRAKE PAD RETAINER PLATE

These retainers are designed to keep the disc brake pad inside the caliper on 1967 Mustangs. Can also be used on 1965/66 cars. **Brake Pad Retainer Plate, Disc**



- 65-67
 C70Z-2B164-A



- 65-66: stainless
 CSZZ-2B127-A

FRONT DISC BRAKE PADS



All new disc brake pads are supplied to us by brand name manufacturers for the best in customer

satisfaction. Boxed sets of four pads. Organic linings. Also available in semi-metallic.

Brake Pads, Front Disc

- 65-67 CSZZ-2018-BR
- 65-67 Semi-metallic CSZZ-2018-SM
- 68-73 D00Z-2018-CR
- 68-73 Semi-metallic D00Z-2018-SM

NEW DISC BRAKE CALIPER



No core charge. These are new calipers using the finest quality parts. They feature new stainless steel pistons, all new seals, new guide

bolts, new hardware and are 100% pressure tested. Pads are not included. Note: will also fit 1967, but must purchase a brake fitting adapter from your local auto parts store.

Caliper, New Disc Brake

- 65-66 CSZZ-2B120/1-CR

DISC BRAKE CALIPER CROSS OVER LINE



Precision made brake lines with correct fittings.

- Caliper Cross Over Line, Disc Brake**
 65-67 MCL001
 65-67 stainless MCL001S

CALIPER DUST SEAL RETAINER



Steel retainer. One for each piston is required.

- Caliper Dust Seal Retainer**
 65-67 CSZZ-2A492-A

DISC BRAKE CALIPER PISTON



Quality stainless steel construction.

- Caliper Piston, Disc Brake**
 65-66 stainless CSZZ-2196-A

CALIPER REBUILD KIT

All necessary parts for overhauling disc brake calipers. Includes all new piston seals and dust boots. Each kit contains the parts for one caliper assembly.

Caliper Rebuild Kit



- 65-67: One side only
 CSZZ-2B120/1-K



- 68-73: One side only
 C8ZZ-2B120/1-HK



- 68-73: One side only
 C8ZZ-2B120/1-SK

DISC BRAKE ROTOR



Excellent quality replacements. Includes hub, studs, and bearing races.

Rotor, Disc Brake

- 65-67 Concours, 2 piece, USA CSZZ-1102-B
 65-67 1 piece, USA CSZZ-1102-BR
 65-67 1 piece, imported CSZZ-1102-BRI
 68-69 Concours, 2 piece, USA C80Z-1102-A
 68-69 1 piece, USA C80Z-1102-AR
 68-69 1 piece, Imported C80Z-1102-ARI
 70-73 1 piece, USA D00Z-1102-BR
 70-73 Imported D00Z-1102-BRI

TURBO ROTOR UPGRADE KIT



This kit includes SSBC turbo slotted rotors, high performance brake pads and any necessary hardware. bolts directly to stock

spindles and calipers offering a low cost performance upgrade. Front brakes only.

Rotor Upgrade Kit, Turbo

- 65-67 Turbo slotted DBC-A2360000
 68-69 Turbo slotted DBC-A2360001
 70-73 Turbo slotted DBC-A2360002

DRUM BRAKE COMPONENTS

BRAKE DRUM



These new brake drums are perfect replacements for tired and thin originals. Front drums do not include studs or a hub.

Brake Drum

- 64-66 Rear 9"x2 1/4" CODZ-1126-BR
 64-66 Front, 6 cyl. C1DZ-1102-BR
 64-73 Rear, 6 cyl. CODZ-1126-CR
 64-73 Front, 8 cyl. C30Z-1102-DR
 64-73 Front, imported C30Z-1102-DRI
 64-73 Rear, 10"x2" C30Z-1126-AR
 64-73 Rear, 8 cyl. C30Z-1126-BR
 64-73 Rear, 10"x2", imported .. C30Z-1126-BRI
 67-70 Front, 6 cyl. C60Z-1102-GR

BRAKE HUB GREASE CAP



Stamped steel with gold dichromate finish.

Brake Hub Grease Cap

- 64-66 6 cyl. C3DZ-1131-A
 64-69 8 cyl. B5A-1131-A

BRAKE SPRING & HOLD DOWN KIT



These kits contain all the replacement springs and hold downs required to do a professional job on drum brakes. Kit

includes enough parts for two wheels.

Brake Spring And Hold Down Kit

- 64-70 Rear 9" CSZZ-2035-BK
 64-71 Front & rear 10"x2" CSZZ-2035-CK
 64-71 Rear, 10"x1.75" CSZZ-2035-DK
 64-73 Front 9" CSZZ-2035-AK
 64-73 64-71 Front & 72-73 rear, 10"x2" D2ZZ-2035-EK
 72-73 Rear, 10"x1.75" D2ZZ-2035-FK

DRUM BRAKE HUB



A quality reproduction is now available. Studs not included

Drum Brake Hub

- 64-66 6 cyl. C3DZ-1107-HUB
 64-69 8 cyl. CSZZ-1107-HUB

DRUM BRAKE SHOE



These relined shoes have bonded linings made to original manufacturer's

specifications. No core required. Sets of 4 shoes.

Drum Brake Shoe

- 64-70 Rear, 6 cyl., except CV C4AZ-2001-AR
 64-70 Front, 6 cyl. C4DZ-2001-AR
 64-70 Rear, 6 cyl., CV only C4DZ-2001-AR
 64-71 Front, 250 6 cyl. & SB only C70Z-2001-BR
 64-73 Rear, 250 6 cyl. & SB only C7ZZ-2200-AR
 67-73 Front, 351 & BB only C60Z-2001-AR
 68-73 Rear, 351 & BB only C60Z-2200-AR

FRONT WHEEL BEARING AND RACE



U.S. made quality bearings.

Front Wheel Bearing and Race

- 64-66 Inner, 6 cyl., drum CSZZ-1201-A
 64-66 Outer, 6 cyl., drum CSZZ-1216-A
 64-69 Inner, V8 B5A-1201-A
 64-69 Outer, V8 B5A-1216-A
 69 Inner, Boss, disc C9ZZ-1201-A
 69 Outer, Boss, disc C9ZZ-1216-A
 70-73 Inner D0ZZ-1201-A
 70-73 Outer D0ZZ-1216-A

REAR WHEEL BEARING



High quality part made in the U.S.A.

Rear Wheel Bearing

- 64-73 V8, 8 & 9" rear end, 28 spline .. CSZZ-1225-A
 65-70 6 cyl., 24 spline CSZZ-1225-B

FRONT DRUM WHEEL STUD



Name brand. Made in the U.S.A.

Wheel Stud, Front Drum

- 64-66 Front C3AZ-1107-A
 64-73 Rear CSZZ-1107-A

SELF ADJUSTER REPAIR KIT



These kits contain all the parts necessary to refurbish the self adjusting mechanism on drum brakes.

Includes new cable and guide, ratchet, spring, and all necessary small parts. Kits include everything for one wheel.

Self Adjuster Repair Kit

64-70 RH, 9"	C5ZZ-2041-AK
64-70 LH, 9"	C5ZZ-2041-BK
64-73 RH, 10"	C5ZZ-2041-CK
64-73 LH, 10"	C5ZZ-2041-DK

ELECTRICAL BRAKE PARTS

BRAKE EXTENSION LEAD



Connects brake master cylinder brake switch to engine gauge harness.

Brake Extension Lead

64	C4ZZ-2140-EXT
----------	---------------

BRAKE LIGHT SWITCH ADAPTER



This is a high quality precision machined brass adapter.

Brake Light Switch Adapter

64	DBC-A0813
----------	-----------

BRAKE PRESSURE SWITCH



This switch mounts on the brake junction block to warn the driver of potential brake failure through a warning light on the dash.

Brake Pressure Switch

67-69	C8AZ-2B264-A
-------------	--------------

STOP LIGHT SWITCH



High quality replacement part. Non-original appearance

Stop Light Switch

64 Early, 2 prong	C4DZ-13480-A
65-70 Manual	C9ZZ-13480-A
67-68 Power disc	C9VY-13480-A
67-70 Power drum	C9ZZ-13480-B
71-73 Manual	D1ZZ-13480-A
71-73 Power	D1ZZ-13480-B

HYDRAULICS

BRAKE AND FUEL LINE CLIP KIT



Convenient kit which mounts front to rear gas lines and long brake line. Kit includes all clips, fasteners and instructions.

Brake And Fuel Line Clip Kit

64-67	380374-MK
-------------	-----------

BRAKE HOSE CLIP KIT



These clips attach rubber brake hose to mounting bracket.

Brake Hose Clip Kit

64-73	78-2814
-------------	---------

BRAKE LINE AND FUEL LINE CLIP



Exact copy of the hard to find original. This two piece clip is used to mount gas and/or brake line to floor.

Brake Line And Fuel Line Clip

64-73	380374-S
-------------	----------

BRAKE DISTRIBUTION BLOCK



These are late model units that are not direct replacements and will require bending brake lines. Highly

recommend when converting 64-66 over to dual chamber master cylinder.

Brake Distribution Block

64-73	C7ZZ-2B257-A
-------------	--------------

DISC BRAKE HOSE



Original equipment style hoses feature Ford Spec fittings. Quality American made replacements. Front.

Brake Hose, Disc

64-66 RH or LH	C5ZZ-2078-AR
67 RH or LH	C7OZ-2078-BR
68-70 RH	C8ZZ-2078-AR
68-70 LH	C8ZZ-2078-BR
71-73 RH	D1ZZ-2078-CR
71-73 LH	D1ZZ-2078-DR

DRUM BRAKE HOSE



These original style hoses feature factory specification fittings. Made in the U.S.A.

Brake Hose, Drum

64 Early 1964, front	B7AZ-2078-AR
64-66 Late 1964, front	C5ZZ-2078-BR
67-70 Front	C7ZZ-2078-AR
71-73 Front	D1ZZ-2078-ER

FRONT BRAKE LINE CLIP & GROMMET KIT



These original style clips are the ones that hold your metal brake lines to the firewall. Also includes rubber brake line

grommets which fit in shock tower for brake line protection.

Brake Line Clip and Grommet Kit, Front

64-67	379604-AK
67-69	379604-BK

FRONT BRAKE LINE KIT



Exact copies of originals. Steel tubing features tin/lead coating & plated zinc chromate fitting. Color coded fittings.

Brake Line Kit, Front

64-65 std. brakes (3 pc)	MFB001
64-65 " " , stainless	MFB001S
64-65 Power brakes	MFB015
64-65 " " , stainless	MFB015S
65-66 GT disc (6 pc)	MFB003
65-66 " " , stainless	MFB003S
66 std. brakes (3 pc)	MFB002
66 " " , stainless	MFB002S
66 Power brakes	MFB016
66 " " , stainless	MFB016S
67 Power disc only (4 pc, before 2/1/67) w/ proportioning valve at rear of car	MFB006
67 " " , stainless	MFB006S
67 drum only (5 pc, before 2/1/67)	MFB007
67 " " , stainless	MFB007S
67 disc (4 pc, after 2/1/67)	MFB012
67 disc (5 pc, after 2/1/67), stainless	MFB012S
67 drum (5 pc, after 2/1/67)	MFB013
67 drum (5 pc, before 2/1/67), stainless	MFB013S
67 Power drum (5 pc)	MFB017
67 " " , stainless	MFB017S
68-69 drum only (5 pc)	MFB004
68-69 " " , stainless	MFB004S
68-69 Power disc only (6 pc)	MFB005
68-69 " " , stainless	MFB005S
68-69 Power drum	MFB018
69-70 Boss 429, power disk brakes only (4 pc) ..	MFB010
69-70 " " , stainless	MFB010S
70 Power disc only (4 pc)	MFB011
70 " " , stainless	MFB011S
71-73 std. drum only (5 pc)	MFB008
71-73 " " , stainless	MFB008S
71-75 Power disk brakes only (5 pc)	MFB009
71-75 " " , stainless	MFB009S

FRONT TO REAR BRAKE LINE KIT



Quality lines with correct fittings. These extra long lines have been gently bent in

half so they are UPS shippable

Brake Line Kit, Front To Rear

64-66	Front drum w/ single exhaust ...	MLB001
64-66	" " , stainless	MLB001S
64-66	Front disc w/ dual exhaust	MLB003
64-66	" " , stainless	MLB003S
64-66	Front disc w/ single exhaust	MLB009
64-66	" " , stainless	MLB009S
64-66	Front drum w/ dual exhaust	MLB013
64-66	" " , stainless	MLB013S
67	Front disc only, (2 pc, before 2/1/67) w/ proportioning valve at rear of car ..	MLB004
67	" " , stainless	MLB004S
67	Front drum (before 2/1/67)	MLB005
67	" " , stainless	MLB005S
67	Front disc (2 pc, after 2/1/67)	MLB008
67	" " , stainless	MLB008S
67	Front drum (after 2/1/67)	MLB012
67	" " , stainless	MLB012S
68-69	All	MLB002
68-69	" " , stainless	MLB002S
70	Front disc	MLB007
70	" " , stainless	MLB007S
70	Front drum	MLB010
70	" " , stainless	MLB010S
71	Front power or std. drum	MLB014
71	" " , stainless	MLB014S
71	Front disc	MLB015
71	" " , stainless	MLB015S
72-73	Front disc	MLB006
72-73	" " , stainless	MLB006S
72-73	Front drum	MLB011
72-73	" " , stainless	MLB011S

MASTER CYLINDER BRAKE LINE KIT

See "Master Cylinder & Power Assist" section in Brakes

POWER BOOSTER BRAKE LINE KIT

See "Master Cylinder & Power Assist" section in Brakes

REAR BRAKE HOSE



Quality American made replacement hose assemblies for the rear brakes.

Brake Hose, Rear

64-66	All except GT	C5ZZ-2282-AR
65-66	GT or factory dual exhaust ..	C5ZZ-2282-DR
67-69	All Except Boss & 428	C7ZZ-2282-AR
70	DoZZ-2282-AR
71-73	D1ZZ-2282-AR

REAR END HOUSING BRAKE LINE KIT



These lines run from rear end junction box to each rear wheel cylinder. Precisely bent, exact copy.

Brake Line Kit, Rear End Housing

64-66	8 cyl., except GT	MHB001
64-66	" " , stainless	MHB001S
64-66	6 cyl.	MHB002
64-66	" " , stainless	MHB002S
64-66	8 cyl., dual exhaust	MHB004
64-66	" " , stainless	MHB004S
65-66	8 cyl., 9"	MHB007
65-66	" " , stainless	MHB007S
67	8 cyl., 9"	MHB012
67	" " , stainless	MHB012S
67-69	8 cyl., 8"	MHB003
67-69	" " , stainless	MHB003S
67-69	6 cyl.	MHB010
67-69	" " , stainless	MHB010S
68	8 cyl., 9", 28 spline	MHB011
68	" " , stainless	MHB011S
68-69	8 cyl., 9", 31 spline	MHB006
68-69	" " , stainless	MHB006S
69	8 cyl., 9", 28 spline	MHB013
69	" " , stainless	MHB013S
70	8 cyl., 9"	MHB008
70	" " , stainless	MHB008S
70	8"	MHB009
70	" " , stainless	MHB009S
71-73	MHB005
71-73	Stainless	MHB005S

BRAKE LINE PRESSURE GAUGE KIT



A perfect accessory for the disc brake proportioning valve. Monitor brake line pressure. Necessary to diagnose brake

systems.

Brake Line Pressure Gauge Kit

64-73	7 Piece kit	DBC-A1704
-------	-------------------	-----------

DISC BRAKE PROPORTIONING VALVE

This aftermarket proportioning valve is far superior to the original equipment. Fully adjustable for tuning front to rear brake bias. Requires some routing modifications of brake lines for proper fit. Includes adapter fittings

Disc Brake Proportioning Valve



64-73	C5ZZ-2B091-R
-------	--------------



64-73: Polished	A0730P
64-73: Black anodized	A0730

PROPORTIONING VALVE REBUILD KIT



Rebuild your proportioning valve and stop leaks. Kit includes 4 seals and retaining ring. Note: Ford had two versions,

externally identical but internally different. This kit fits the most common later version. Not returnable if opened.

Proportioning Valve Rebuild Kit

65-66	C5ZZ-2B091-K
-------	-------	--------------

BRAKE WHEEL CYLINDER



All brand new, American made, quality castings and parts.

Brake Wheel Cylinder

64	6 cyl., rear, RH or LH	C3DZ-2261-AR
64-66	6 cyl., rear, RH or LH	C5DZ-2261-AR
64-70	6 cyl., front, RH	C5DZ-2061-AR
64-70	6 cyl., front, LH	C5DZ-2062-AR
64-72	V8, rear, RH, 29/32"	C30Z-2261-BR
64-72	V8, rear, LH, 29/32"	C30Z-2262-BR
64-73	V8, front, RH	C30Z-2061-BR
64-73	V8, front, LH	C30Z-2062-BR
67-69	351-428, rear, RH, 13/16" ..	C7ZZ-2261-AR
67-69	351-428, rear, LH, 13/16" ...	C7ZZ-2262-AR
67-69	V8, front, RH, 1 3/32"	C9TZ-2061-BR
67-69	V8, front, LH, 1 3/32"	C9TZ-2062-BR
67-73	200/289/302, rear, RH, 7/8" ..	C60Z-2261-AR
67-73	200/289/302, rear, LH, 7/8" ..	C60Z-2262-AR

MASTER CYLINDERS & POWER ASSIST

DISC BRAKE MASTER CYLINDER



New, not rebuilt. Includes new cap and diaphragm

C5ZZ-2140-CR

Master Cylinder, Disc Brake

64-66	Manual disc	C5ZZ-2140-CR
64-73	Billet & polished	C5ZZ-2140-MB
64-73	4 wheel disc	C7ZZ-2140-4WDB
67-72	Power disc	C8ZZ-2140-AR
72-73	Power disc	D2ZZ-2140-AR

WE PROUDLY FEATURE AUTHENTIC MUSTANG REPRODUCTIONS FROM SCOTT DRAKE ENTERPRISES!



DRUM BRAKE MASTER CYLINDER



Brand new units, not rebuilt. High quality American made parts

- 64-66 **Master Cylinder, Drum Brake**
- 64-65 Manual drum C4AZ-2140-BR
- 64-65 Power drum C5ZZ-2140-BR
- 66 Power drum C6AZ-2140-BR
- 66 Manual drum C6ZZ-2140-BR
- 67-70 Power drum C7ZZ-2140-GR
- 67-70 Manual drum C9AZ-2140-DR
- 71-72 Early 1972, manual drum D1ZZ-2140-AR
- 72-73 Late 1972, manual drum D2ZZ-2140-CR

MASTER CYLINDER PUSHROD BUSHING



Made of white nylon for long life

- 65-69 **Master Cylinder Pushrod Bushing**
- 65-69 C5DZ-2474-A

PUSH ROD POWER BRAKE BOOSTER SEAL



Seals power brake booster push rod to firewall.

- 65-66 **Power Brake Booster Seal, Push Rod**
- 65-66 C5ZZ-2021

DISC BRAKE MASTER CYLINDER CAP

Now made by Scott Drake. Our caps feature exact letter stamping detail on top. Rubber diaphragm and bail wire included. Available with a gold cadmium finish like original, or a chrome finish.

Master Cylinder Cap, Disc Brake



- 64-66: Disc brake, gold zinc
- C5ZZ-2162-GZ



- 64-66: Disc brake, chrome
- C5ZZ-2162-DR



- 67-73: Disc brake, gold cadmium
- C7AZ-2162-B



- 67-73: Disc brake, chrome
- C7AZ-2162-CR

DRUM BRAKE MASTER CYLINDER CAP

Made by Scott Drake. This cap features exact details in the lettering. Includes diaphragm, gold, silver or chrome. Our 64-66 cap is also available in a machined 6061 billet version for a custom look.

Master Cylinder Cap, Drum Brake



- 64-66: Drum brake, billet
- B-2162-A



- 64-66: Drum brake, chrome
- C5ZZ-2162-BC



- 64-66: Drum brake, silver
- C5ZZ-2162-5



- 65-66: Drum brake, gold cadmium
- C5ZZ-2162-B



- 67-73: Power drum, gold
- C9AZ-2162-B



- 67-73: Power drum, chrome
- C9AZ-2162-C

MASTER CYLINDER CAP DIAPHRAGM

Fits underneath master cylinder cap to prevent leaks.

Master Cylinder Cap Diaphragm



- 64-66: disc
- C5ZZ-2167-A



- 67-73: disc
- C7AZ-2167-A



- 67-73: drum
- C9AZ-2167-B

DUAL CHAMBER POWER BRAKE CONVERSION KIT



This setup utilizes a new power brake booster with increased sensitivity, new large capacity dual chamber

master cylinder, specially designed mounting bracket to allow direct bolt in while retaining original brake pedal assembly and clearance of the shock tower*. Note: Booster requires a minimum 15 inches of engine vacuum pressure at idle for maximum stopping power. Some high performance high lift camshafts may not create enough vacuum. Stock engine vacuum pressure is 18 inches. 1 year warranty. Picture for reference only. *Check website for actual picture of each kit. Will not fit cars with factory power brakes. Installation instructions are not included as this kit should be installed by a trained professional. We recommend part number PBC-MCL on the following page to ease installation. Early cars may also require a brake distribution block. *Note: PBC-M1 & PBC-M2 require notching factory shock tower brace, therefore an Export Brace is recommended.*

Power Brake Conversion Kit, Dual Chamber

Master

- 64-66 disc, auto. PBC-A1
- 64-66 drum, auto. PBC-A2
- 64-66 4 wheel disc, auto. PBC-A1-4WDB
- 64-66 disc, manual PBC-M1
- 64-66 drum, manual PBC-M2
- 64-66 disc w/ 4 speed transmission, alum. master PBC-M1-ALUM-MC
- 64-66 Manual, w/ billet master cyl. PBC-M4
- 67-70 disc, auto. PBC-67-1
- 67-70 drum, auto. PBC-67-2
- 67-70 disc, manual PBC-67-3
- 67-70 drum, manual PBC-67-4
- 67-70 4 wheel disc, automatic .. PBC-67-4WDB

SINGLE CHAMBER POWER BRAKE CONVERSION KIT



Single chamber master cylinder Power Brake Conversion. Perfect for customers looking for a more original

appearance or a simpler installation. Uses stock manual brake pedal.

Power Brake Conversion Kit, Single Chamber

- 64-66 drum w/ auto. PBC-A3
- 64-66 drum w/ manual PBC-M3

7" POWER BRAKE BOOSTER AND DUAL MASTER CYLINDER



Compliment to the 65-66 drum to disc conversions. Greatly increases your stopping power. Includes 7" booster

and dual master cylinder. Note: For automatic cars only. Features adjustable push rod.

Power Brake Booster And Master Cylinder, 7"

64-66DBC-A28143

MASTER CYLINDER BRAKE LINE KIT



Exact copies of the originals. Steel tubing features tin/lead coating and plated zinc chromate finishing.

Brake Line Kit, Master Cylinder

64-65	std. brakes	MML001
64-65	" " , stainless	MML001S
64-65	Power drum	MML015
64-65	" " , stainless	MML015S
65-66	GT disc	MML003
65-66	" " , stainless	MML003S
66	std. brakes	MML002
66	" " , stainless	MML002S
66	Power drum	MML016
66	" " , stainless	MML016S
67	Power disc	MML006
67	" " , stainless	MML006S
67	drum only (before 2/1/67)	MML007
67	" " , stainless	MML007S
67	disc after 2-1-67	MML012
67	" " , stainless	MML012S
67	drum after 2-1-67	MML013
67	" " , stainless	MML013S
67	Power drum	MML017
67	" " , stainless	MML017S
68-69	std. brakes	MML004
68-69	" " , stainless	MML004S
68-69	Power disc	MML005
68-69	" " , stainless	MML005S
68-69	Power drum	MML018
68-69	" " , stainless	MML018S
69-70	Boss 429	MML010
69-70	" " , stainless	MML010S
70	Power disc only	MML011
70	" " , stainless	MML011S
70	drum	MML014
70	" " , stainless	MML014S
71-73	drum only (after 2/1/67)	MML008
71-73	" " , stainless	MML008S
71-73	disc (after 2/1/67)	MML009
71-73	" " , stainless	MML009S

POWER BOOSTER BRAKE LINE KIT

Power Booster Brake Line



Brake Line Kit, Power Booster

64-65	Steel	MPL002
64-65	Stainless	MPL002S
66	Steel	MPL001
66	Stainless	MPL001S

POWER BRAKE BOOSTER VACUUM LINE

Screws into intake manifold and runs to rubber hose from



power booster. Quality construction.

Power Brake Booster Vacuum Line

64-65	260, 289	MVB002
64-65	260, 289 stainless	MVB002S
68-69	302, 351	MVB001
68-69	302, 351 stainless	MVB001S
68-69	428	MVB003
68-69	428, stainless	MVB003S
68-69	428 Shelby	MVB004
68-69	428 Shelby, stainless	MVB004S

POWER BRAKE CONVERSION LINE

& FITTING



This kit includes two 15 inch straight lines with the correct double flare on one end and fittings for the master cylinder.

We have included extra

fittings to accommodate most cars. Although this kit is intended for the trained professional installing our conversion kits, customers with the correct flaring and bending tools will find this kit convenient to use and a time saver.

Power Brake Conversion Line And Fitting

65-73PBC-MCL

MASTER CYLINDER ADJUSTABLE PUSH ROD

Used when brake booster is removed for non power brake application. This rod may require alterations in some applications.



Allows for fine tuning for desired pedal height.

Push Rod, Master Cylinder Adjustable

64-69 A21161

PARKING BRAKE COMPONENTS

PARKING BRAKE ASSEMBLY



Complete assemblies as sold from Ford. Good reproductions includes either plastic pull handle or rubber pad pedal.

Parking Brake Assembly

64-66	C5ZZ-2780-A
67-68	C7ZZ-2780-A
69	C9ZZ-2780-A
70	DOZZ-2780-A

PARKING BRAKE HANDLE

High quality injection molded parts, mounting lock pin and allen set screw included. Excellent detail in a reproduction part. Black with white "Brake" lettering (1964 - 1966) on ribbed face of handle. Later handles (1967 - 1968) are all black. New improved metal insert. Thicker than original. Includes original drive pin as well as an allen head socket set screw to allow easy removal and installation in the future.

Parking Brake Handle



64-66
CODZ-2760-B



67-68
C7ZZ-2760-B

PARKING BRAKE PULLEY



The pulley that the emergency brake cable rides on.

Parking Brake Pulley

65-68 Gold anodizedOM-2804

FRONT PARKING BRAKE CABLE



Fits from handle to equalizer. One required per car. All fit 6 or 8 cylinder. Cable only. **Also available, concours correct**

versions for 64-68, see "Concours Front Parking Brake Assemblies".

Parking Brake Cable, Front

64-66	C5ZZ-2853-BR
67-68	C7ZZ-2853-AR
69-70	C9ZZ-2853-AR
71-73	D1ZZ-2853-AR

WE PROUDLY FEATURE AUTHENTIC MUSTANG REPRODUCTIONS FROM SCOTT DRAKE ENTERPRISES!



CONCOURS FRONT PARKING BRAKE CABLE ASSEMBLY

New by Scott Drake, these are made just like the originals with correct outer casing. Includes firewall seal, firewall bracket and retaining clip. **Parking Brake Cable Assembly, Concours Front**

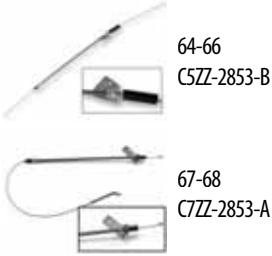

64-66
C5Z-2853-B
67-68
C7Z-2853-A

REAR PARKING BRAKE CABLE

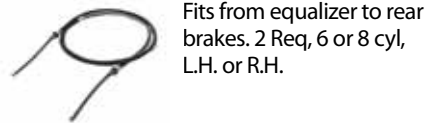

Fits from equalizer to rear brakes. 2 Req, 6 or 8 cyl, L.H. or R.H.

Parking Brake Cable, Rear

- 65 6 or 8 cyl., RH or LH (2 req.) .. C5Z-2A635-ER
- 66 6 or 8 cyl., RH or LH (1 req.) .. C6Z-2A635-CR
- 67 6 or 8 cyl., RH or LH (2 req.) . C7Z-2A635-AR
- 67-70 For rear disc not SSBC ... C7Z-2A635-RDB
- 68 6 cyl., RH (1 req.) C8Z-2A635-BR
- 68 8 cyl., RH (1 req.) C8Z-2A635-DR
- 68-69 8 cyl., LH (1 req.) C8Z-2A635-AR
- 68-70 6 cyl., LH (1 req.) C8Z-2A635-CR
- 69 6 cyl., RH (1 req.) for early style cars built before 2-17-69 C9Z-2A635-AR
- 69 8 cyl., RH (1 req.) C9Z-2A635-CR
- 70-73 8 cyl., RH (1 req.) D0Z-2A635-AR
- 70-73 8 cyl., LH (1 req.) D0Z-2A635-BR

PARKING BRAKE CABLE BRACKET



Required to correctly hold the parking brake cable in place.

Parking Brake Cable Bracket

- 64-65 C5Z-2649-C/D
- 66 C6Z-2649-C/D

PARKING BRAKE CABLE CONNECTOR



This is the saddle shaped piece that connects the two rear parking brake cables together.

Parking Brake Cable Connector

- 67-73 C60Z-2A790-A

PARKING BRAKE CABLE IDLER



Keeps proper tension on emergency brake cable by taking up the slack when the brake is off.

Parking Brake Cable Idler

- 67-73 C7Z-2A808-A

PARKING BRAKE CABLE IDLER BRACKET



This bracket mounts to the floor pan and acts as an anchor for the idler. Welding required.

Parking Brake Cable Idler Bracket

- 67-73 C7Z-2A816-A

PARKING BRAKE EQUALIZER

Parking Brake Equalizer. Zinc plated for years of service. Made by Scott Drake **Parking Brake Equalizer**



65
C5Z-2A602-A



66
C0DD-2A602-A



67-70
C60Z-2A602-A

PARKING BRAKE EQUALIZER LEVER



Made from heavy gauge stamped steel, a quality reproduction.

Parking Brake Equalizer Lever

- 65-66 C5Z-2A605-A
- 67-68 C7Z-2A605-A

PARKING BRAKE EQUALIZER ROD



Concours reproduction that is zinc plated.

Parking Brake Equalizer Rod

- 64-66 B7A-2628-B
- 67-68 C7Z-2628-B

PARKING BRAKE LEVER SPRING



Exact O.E.M. replacement, not an over the counter universal spring. Painted black.

Parking Brake Lever Spring

- 64-66 C5Z-2A651-A

PARKING BRAKE PEDAL PAD



Made by Scott Drake, this Parking Brake Pad is an exact copy of the original. Molded from wear resistant rubber for years of use.

Parking Brake Pedal Pad

- 69-73 Note: Will not fit 1970 Mustang or Cougar
C9Z-2454-A

PARKING BRAKE PEDAL PAD TRIM



Made from stainless steel, just like the originals.

Parking Brake Pedal Pad Trim

- 69-73 Note: Will not fit 1970 Mustang or Cougar
C9Z-2A487-C

BUMPERS

BUMPER COMPONENTS

BUMPER WAVE WASHER



Stamped of spring steel and zinc plated to stop rust.

Bumper Wave Washer

- 64-70 C5Z-17A924

BUMPER BOLT



A variety of bumper bolts are offered to fit your application.

Bumper Bolt

- 64-68 Concours C4ZB-17758-A
- 64-68 Replacement C5Z-17758-A
- 64-70 Small 376337-S

BUMPER BOLT KIT



These time saving kits contain everything you need to install the front and rear bumpers. Deluxe kits include wave washers.

Bumper Bolt Kit

- 64-68 Concours, dlx. C4ZB-17758-DLXK
- 64-70 dlx. 28 piece kit C5Z-17758-DLXK
- 64-70 std. 20 piece kit C5Z-17758-K
- 69-70 std. 20 piece kit C9Z-17758-K

BUMPER GUARD CUSHION



Used to deaden the noise between the bumper and bumper guards. Quality molded rubber.

Bumper Guard Cushion

64-66 Set of 4 379944-5

BUMPER NUT



Special serrated flange nut. Attaches to bumper bolts.

Bumper Nut

64-73 7/16x14" threads 375918-5

FRONT BUMPERS

CHROME FRONT BUMPER



Chrome finish gives the car a nice look. Both versions offer an affordable alternative to expensive re-chroming. Bumper bolts not included. *USA made bumper available early 2009*

Bumper, Chrome Front

64-66 Made in USA C5ZZ-17757-A
64-66 Made in Taiwan C5ZZ-17757-AR
67-68 Made in USA C7ZZ-17757-A
67-68 Made in Taiwan C7ZZ-17757-AR
69-70 Made in USA C9ZZ-17757-A
69-70 Made in Taiwan C9ZZ-17757-AR
71-72 Made in Taiwan D1ZZ-17757

INNER FRONT BUMPER BRACE



Stamped from a heavy gauge metal. Painted black.

Bumper Brace, Inner Front

64-66 RH C5ZZ-17766-AR
64-66 LH C5ZZ-17767-AR
67-68 RH C7ZZ-17766-AR
67-68 LH C7ZZ-17767-AR
69-70 RH C9ZZ-17766-AR
69-70 LH C9ZZ-17767-AR
71-73 RH D1ZZ-17766-AR
71-73 LH D1ZZ-17767-AR

OUTER FRONT BUMPER BRACE



Tubular construction, painted black.

Bumper Brace, Outer Front

64-66 RH C5ZZ-17754-AR
64-66 LH C5ZZ-17755-AR
67-68 RH C7ZZ-17754
67-68 LH C7ZZ-17755
69-70 RH C9ZZ-17754-AR
69-70 LH C9ZZ-17755-AR

FRONT BUMPER BRACKET



Steel stamping. Secures bumper to front fender side.

Bumper Bracket, Front

64-66 RH C5ZZ-17A869-A
64-66 LH C5ZZ-17A870-A
67-68 RH C7ZZ-17A869-A
67-68 LH C7ZZ-17A870-A
69-70 RH or LH C9ZZ-17B762-A

FRONT BUMPER GUARD



Features a heavy gage steel stamping. These are the best on the market. Flawless chrome. Sold in pairs.

Bumper Guard, Front

64-66 C5ZZ-17996/7-CB
67-68 C7ZZ-17996/7-A
67-68 w/out trim holes C7ZZ-17996/7-B

FRONT BUMPER GUARD BRACKET



Die stamped from heavy gauge steel and painted black. Perfect copy. Mounts on inner bumper brace.

Bumper Guard Bracket, Front

64-66 C5ZZ-17B794-A

FRONT BUMPER GUARD

HARDWARE KIT



These kits make mounting bumper guards a breeze.

Bumper Guard Hardware Kit, Front

64-66 Bolt kit 359530-K
64-66 Clip kit 370328-K
64-66 Bolt, bracket & clip kit ... C5ZZ-17794-KIT

FRONT BUMPER GUARD TRIM



E.P.D.M. rubber featuring steel insert and mounting studs. Steel insert is cadmium plated to prevent rust. An excellent reproduction.

Bumper Guard Trim, Front

67 C7ZZ-17A812-A

REAR BUMPERS

CHROME REAR BUMPER



Chrome finish gives the car a nice look. Both versions offer an affordable alternative to expensive re-chroming. Bumper bolts not included. *USA made bumper available early 2009*

Bumper, Chrome Rear

64-66 Made in USA C5ZZ-17906-A
64-66 Made in Taiwan C5ZZ-17906-AR
67-68 Made in USA C7ZZ-17906-A
67-68 Made in Taiwan C7ZZ-17906-AR
69-70 Made in USA C9ZZ-17906-A
69-70 Made in Taiwan C9ZZ-17906-AR
71-73 Made in Taiwan D1ZZ-17906-A

REAR BUMPER BODY PAD



Our die cut foam rubber donuts help cushion the brace from the tail panel.

Bumper Body Pad, Rear

65-73 C5ZZ-6540996

REAR BUMPER BRACE



Stamped steel. Painted black. A nice reproduction.

Bumper Brace, Rear

64-66 C5ZZ-17A750-AR
67-68 C7ZZ-17A750-AR
69-70 C9ZZ-17A750-AR
71-72 RH D1ZZ-17A750-AR
71-72 LH D1ZZ-17A751-AR

REAR BUMPER GUARD



Precision steel stamping from heavy gauge steel.

Bumper Guard, Rear

64-66 Chrome C5ZZ-17984-C
67-68 Black C7ZZ-17984-AR
67-68 Chrome C7ZZ-17984-CR

REAR BUMPER GUARD BRACKET



Steel stamping and painted black. Just like originals.

Bumper Guard Bracket, Rear

64-66 C5ZZ-17B876/7-A
67-68 C7ZZ-17B876/7-A

WE PROUDLY FEATURE AUTHENTIC MUSTANG REPRODUCTIONS FROM SCOTT DRAKE ENTERPRISES!



REAR BUMPER GUARD TRIM

Trim that attaches to the rear bumper guards, protecting the chrome.
Bumper Guard Trim, Rear

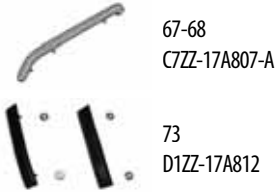

67-68
C7ZZ-17A807-A
73
D1ZZ-17A812

REAR BUMPER LICENSE LAMP



Mounts on rear bumper. Good copy of original, includes lens, bulb and correct wiring pigtail.

Bumper License Lamp, Rear
64-70C5ZZ-13550-A

Convertible PARTS

BOOTS

Convertible TOP BOOT BAG



Heavy vinyl, felt-backed construction. Protects top boot from dirt and grime.

Convertible Top Boot Bag
64-73 Black BB-FM-BK
64-73 Plaid BB-FM-PLD
64-73 Speckled BB-FM-SPK

Convertible TOP BOOT SNAP KIT



Great quality kit. This one features 17 snaps, with correct length and 17 retainers. Snaps are made from stainless steel so they will not rust! 64-66 pictured.

Convertible Top Boot Snap Kit
64-66 359274-SK
67 359274-S67

Convertible TOP BOOT



Made from original patterns for a wrinkle free look. Features perfect fit and long lasting vinyl. Includes foam pads. Will not fit Shelby.

Convertible Top Boot

64-65 BlueC5ZZ-7654400-BL
64-65 RedC5ZZ-7654400-RD
64-66 BlackC5ZZ-7654400-BK
64-66 EmberC5ZZ-7654400-EM
64-66 Ivy goldC5ZZ-7654400-IG
64-66 PalominoC5ZZ-7654400-PA
64-66 WhiteC5ZZ-7654400-WT
66 Dark redC5ZZ-7654400-DR
66 Light blueC5ZZ-7654400-LB
66 ParchmentC5ZZ-7654400-PR
66 TurquoiseC5ZZ-7654400-TQ
67 BlackC7ZZ-7654400-BK
67 Dark redC7ZZ-7654400-DR
67 Ivy goldC7ZZ-7654400-IG
67 Light blueC7ZZ-7654400-LB
67 PalominoC7ZZ-7654400-PA
67 ParchmentC7ZZ-7654400-PR
67 SaddleC7ZZ-7654400-SA
67 TurquoiseC7ZZ-7654400-TQ
67 WhiteC7ZZ-7654400-WT
68 BlackC8ZZ-7654400-BK
68 Dark redC8ZZ-7654400-DR
68 Ivy goldC8ZZ-7654400-IG
68 Light blueC8ZZ-7654400-LB
68 MaroonC8ZZ-7654400-MR
68 PalominoC8ZZ-7654400-PA
68 ParchmentC8ZZ-7654400-PR
68 SaddleC8ZZ-7654400-SA
68 TurquoiseC8ZZ-7654400-TQ
68 WhiteC8ZZ-7654400-WT
69 Dark redC9ZZ-7654400-DR
69 Ivy goldC9ZZ-7654400-IG
69 Light blueC9ZZ-7654400-LB
69 Nugget goldC9ZZ-7654400-NG
69-70 BlackC9ZZ-7654400-BK
69-70 WhiteC9ZZ-7654400-WT
70 BlueC9ZZ-7654400-BL
70 GingerC9ZZ-7654400-GI
70 IvyC9ZZ-7654400-IV
70 VermillionC9ZZ-7654400-VE
71-73 BlackD1ZZ-7654400-BK
71-73 BlueD1ZZ-7654400-BL
71-73 GingerD1ZZ-7654400-GI
71-73 GreenD1ZZ-7654400-GR
71-73 VermillionD1ZZ-7654400-VE
71-73 WhiteD1ZZ-7654400-WT

ELECTRICAL

Convertible TOP HARNESS



This is the main harness for the power convertible top. Made in the USA. Correct color coded wires and factory

style loom cover includes circuit breaker. Note: 64-66 version will also work on 67-68.

Convertible Top Harness

64-68 Concours for 64-66C5ZZ-7615A668
67-68 Concours for 67-68C7ZZ-7615A668

UNDER HOOD Convertible TOP HARNESS



This wiring harness links the convertible top switch to the circuit breaker under the hood on 1964 through 1966 Mustangs.

Convertible Top Harness, Under Hood

64-66C4DZ-15668-B

Convertible TOP SWITCH

Exact copy from Scott Drake. Note: 64-66 knob & bezel sold separately

Convertible Top Switch



64-66
C4DZ-15668-A



67: inc. bezel & knob
C7ZZ-15668-A

Convertible TOP SWITCH BEZEL & KNOB



Quality chrome plated with black painted "UP" and "DN" markings. Retaining nuts included.

Convertible Top Switch Bezel and Knob

64-66C4DZ-10852-K

Convertible TOP TO SWITCH CIRCUIT BREAKER



This wiring harness links the convertible top switch to the circuit breaker under the hood on 1964 through 1966 Mustangs.

Convertible Top To Switch Circuit Breaker

65-70 Does not fit 66C5ZZ-14448-A
66C6ZZ-14448-A

HYDRAULICS

CONVERTIBLE PUMP MOTOR & RESEVIOR

All new, not rebuilt.
Excellent U.S.A. quality



Convertible Pump Motor And Reseivor
64-73C4DZ-7653337-A

CONVERTIBLE TOP HYDRAULIC CYLINDER

These are all new, not rebuilt or off the shelf generic replacements. Guaranteed for one year. Made in USA.



Convertible Top Hydraulic Cylinder
64-70 CSZZ-7650600-AR
71D1ZZ-7650600-A
72-73 LHD2ZZ-7650600-A
72-73 RHD2ZZ-7650601-A

CONVERTIBLE TOP HYDRAULIC HOSE LINE

Clear hydraulic hoses that have the correct brass machined fittings.



Convertible Top Hydraulic Hose Line
64-70 CSZZ-7653456-A

LATCHES & COMPONENTS

CONVERTIBLE TOP CLAMP TRUSS HEAD REPAIR KIT

Designed for easy installation. Does not require top disassembly.



Convertible Top Clamp Truss Head Repair Kit
65-68 380348-S

CONVERTIBLE TOP CLAMP TRUSS HEAD SCREW

Concours correct. Requires top to be disassembled.



Convertible Top Clamp Truss Head Screw
64-68 380348-SK

CONVERTIBLE TOP CLEVIS PIN KIT

This complete 10 piece kit includes nylon bushings, chrome pivot rivets, locking wave washers, and locking clevis pins.



Convertible Top Clevis Pin Kit
64-70 378887-SK

CONVERTIBLE TOP DOWEL PIN

Helps top alignment as top goes down onto our visor brackets.



Convertible Top Dowel Pin
64-68 CSZZ-76514A38-B

CONVERTIBLE TOP HOLD DOWN CLAMP

Made by Scott Drake with exacting details. fits 1965-68 Convertibles with manual tops.



Convertible Top Hold Down Clamp
64-68 RH & LH CSZZ-7650500/1D
64-68 RH CSZZ-7650500-D
64-68 LH CSZZ-7650501-D

CONVERTIBLE TOP HOOK

Beautifully chrome plated, features correct thread size.



Convertible Top Hook
64-66 CSZZ-7650536-A
67-73C6AZ-76506A48-A

CONVERTIBLE TOP LATCH ASSEMBLY

Finished assembly ready to install. Features hold down clamp handle, pivots, spring and top hook.



Convertible Top Latch Assembly
64-68 RH CSZZ-7650508-K
64-68 LH CSZZ-7650509-K

CONVERTIBLE TOP LATCH HANDLE

New Lower Price!



Convertible Top Latch Handle
71-73 RHD1ZZ-7650508-A
71-73 LHD1ZZ-7650509-A

CONVERTIBLE TOP LATCH MOUNTING BASE

This is the base that the latch handle mounts to on the convertible top frame. Sold as a pair.



Convertible Top Latch Mounting Base
64-67 CSZB-7650500/1B

CONVERTIBLE TOP LATCH SPRING

These are the 3 inch springs that keep tension on the convertible top latches, allowing them to lock in place. Sold as a pair.



Convertible Top Latch Spring
64-73 CSZZ-7650572-A

MISCELLANEOUS PARTS

CONVERTIBLE QUARTER PANEL SNAP KIT

Used to mount top boot to quarter panels. Limited supply! Tubular design



must be crimped on. 6 pc kit, Exact Copy.
Convertible Quarter Panel Snap Kit
64-68 CSZZ-7602628-A

CONVERTIBLE TOP TENSION CABLE

A quality rust proof stainless steel cable which features all the correct hardware



Convertible Top Tension Cable
64-65 Stud type CSZZ-7652806-A
65-68 Spring type CSZZ-7652806-B
69-70 C9ZZ-7652806-A

CONVERTIBLE TOP REPAIR MANUAL

The convertible top is the most complicated part of any car. Manual features complete top replacement, adjustments, servicing, electrical and



trouble-shooting. 15 pages soft bond Manual, Convertible Top Repair
64-66 MP-14

MOLDINGS

CONVERTIBLE HEADER MOLDING

Good fitting alternative to the original.



Convertible Header Molding
64-67 Chrome CSZZ-7603606-A
68 Satin C8ZZ-7603606-A

CONVERTIBLE TOP BOOT REAR MOLDING

Features polished stainless steel finish and a great fit. Snaps not included.



Convertible Top Boot Rear Molding
64-66 CSZZ-76423A20-A

WE PROUDLY FEATURE AUTHENTIC MUSTANG REPRODUCTIONS FROM SCOTT DRAKE ENTERPRISES!



CONVERTIBLE TOP BOOT SIDE MOLDING



Now made by Scott Drake. Features beautiful chrome finish and a great fit. Snaps

not included. These are superior to the cheap imported versions available on the market.

Convertible Top Boot Side Molding

64-66 CSZZ-76423A18/9

REAR WINDOW

GLASS CONVERTIBLE TOP REAR WINDOW



Glass rear windows greatly enhance rear visibility. They are not prone to scratching, cracking or yellowing due to exposure to the sun.

Convertible Top Rear Window, Glass

64-66 Black CSZZ-7652500-GB
 64-66 White CSZZ-7652500-GW
 67-70 Black C7ZZ-7652500-GB
 67-70 White C7ZZ-7652500-GW
 71-73 Black D1ZZ-7652500-GB
 71-73 White D1ZZ-7652500-GW

PLASTIC CONVERTIBLE TOP REAR WINDOW



Plastic windows feature heavy duty 40 gauge clear plastic trimmed with premium 38 ounce material and a zipper assembly.

Convertible Top Rear Window, Plastic

64-66 Black CSZZ-7652500-PB
 64-66 White CSZZ-7652500-PW
 67-68 Black C7ZZ-7652500-PB
 67-68 White C7ZZ-7652500-PW
 71-73 Black D1ZZ-7652500-PB
 71-73 White D1ZZ-7652500-PW

SUN VISORS & COMPONENTS

CONVERTIBLE SUN VISOR BRACKET & ROD

Show car quality with triple chrome plating. Includes L.H. & R.H. brackets with attached visor pivot rods.

Convertible Sun Visor Bracket And Rod



64-66
 CSZZ-7604144/5



67-68
 C7ZZ-7604144/5A

CONVERTIBLE VISOR PIVOT ARM



Easy repair kit for those of you who want an economical fix.

Convertible Visor Pivot Arm

64-66 CSZZ-7604144-P

CONVERTIBLE VISOR ROD



Chrome plated 4-piece kit. Pushes in padded sun visors.

Convertible Visor Rod

64-66 CSZZ-7604114-K

CONVERTIBLE SUN VISOR



Convertible visors are covered in the original Sierra Grain vinyl.

Sun Visor, Convertible

64-65 Medium blue CSZZ-7604104-BL
 64-65 Bright red CSZZ-7604104-BR
 64-66 Black CSZZ-7604104-BK
 64-66 Emberglo CSZZ-7604104-EM
 64-66 Ivy gold CSZZ-7604104-IG
 64-66 Palamino CSZZ-7604104-PA
 64-66 Turquoise CSZZ-7604104-TQ
 64-66 White CSZZ-7604104-WT
 65-66 Aqua CSZZ-7604104-AQ
 66 Dark red CSZZ-7604104-DR
 66 Light blue CSZZ-7604104-LB
 66 Parchment CSZZ-7604104-PR
 67-68 Aqua C7ZZ-7604104-AQ
 67-68 Black C7ZZ-7604104-BK
 67-68 Dark blue C7ZZ-7604104-DB
 67-68 Dark red C7ZZ-7604104-DR
 67-68 Ivy gold C7ZZ-7604104-IG
 67-68 Light blue C7ZZ-7604104-LB
 67-68 Parchment C7ZZ-7604104-PR
 67-68 Saddle C7ZZ-7604104-SA
 67-68 White C7ZZ-7604104-WT
 68 Maroon C7ZZ-7604104-MR
 68 Nugget gold C7ZZ-7604104-NG
 69-73 Black C9ZZ-7604104-BK
 69-73 Blue C9ZZ-7604104-BL
 69-73 Dark ivy C9ZZ-7604104-DI
 69-73 Dark red C9ZZ-7604104-DR
 69-73 Green C9ZZ-7604104-GR
 69-73 Ivy gold C9ZZ-7604104-IG
 69-73 Light blue C9ZZ-7604104-LB
 69-73 Nugget gold C9ZZ-7604104-LN
 69-73 Parchment C9ZZ-7604104-PR
 69-73 Vermillion C9ZZ-7604104-VE
 69-73 White C9ZZ-7604104-WT

TOPS, PADS & TACK STRIPS

CONVERTIBLE TOP W/ GLASS BACK WINDOW



Glass rear windows greatly enhance rear visibility. They are not prone to scratching,

cracking or yellowing due to exposure to the sun. 1964 - 1970 rear windows have a visible urethane folding seam. 1971 - 1973 are solid glass. 1964 - 1966 must use 67 - 70 convertible well liner. 1964 - 1970 folding seam carries an 18 month warranty against splitting or separation. Glass rear window and top are now packaged in 1 box to save on shipping cost.

Convertible Top With Glass Back Window

64-66 Black CSZZ-7652701-PB
 64-66 White CSZZ-7652701-PW
 67-68 Black C7ZZ-7652701-PB
 67-68 White C7ZZ-7652701-PW
 69-70 Black C9ZZ-7652701-PB
 69-70 White C9ZZ-7652701-PW
 71-73 Black D1ZZ-7652701-PB
 71-73 White D1ZZ-7652701-PW

CONVERTIBLE TOP W/ PLASTIC BACK WINDOW



Scott Drake tops are made from premium-grade 38 ounce material. Rear windows are included. Stocked in Black or White,

however we can special order Tan, Dark Blue, Maroon, Red, Green, Brown, Saddle and Gold. When quality matters, use the best! Special order colors are non-returnable and have an extra upcharge. All of our tops feature: Assembled front edge bulb seal, Pre-shrunk for a better fit, Specially treated vinyl to resist mildew, 5 year pro-rated guarantee against cracking, peeling, separating and excess fading, Coated vinyl for extra waterproofing, Factory original pinpoint grain, Heavy duty nylon easy glide zipper, Includes wire-on, stainless tips and stainless screws, Meets motor vehicle fire retardant requirements.

Convertible Top With Plastic Back Window

64-66 Medium blue CSZZ-7652700-BL
 64-66 Black CSZZ-7652700-PB
 64-66 White CSZZ-7652700-PW
 67-68 Black C7ZZ-7652700-PB
 67-68 White C7ZZ-7652700-PW
 69-70 Black C9ZZ-7652700-PB
 69-70 White C9ZZ-7652700-PW
 71-73 Black D1ZZ-7652700-PB
 71-73 White D1ZZ-7652700-PW

BULK CONVERTIBLE TACK STRIP



Bulk Conv Tack Strip/50 FT roll. Fits front only.

Convertible Tack Strip, Bulk
64-73 CSZZ-76-TS-BULK

CONVERTIBLE TOP PAD



Quality construction. Used to cushion and protect top vinyl from excessive wear from side rails.

Convertible Top Pad
64-70 Black CSZZ-7652875-BK
69-70 Black C9ZZ-7652875-BK
71-73 Black D1ZZ-7652875-BK

CONVERTIBLE TOP REAR TACK STRIP KIT



Metal tack strip complete with fiberboard insert for proper staple fastening.

Convertible Top Rear Tack Strip Kit
64 MM-043
65-66 MM-143
67-68 MM-243
69-70 MM-343
71-73 MM-443

WEATHER SEALS

CONVERTIBLE PILLAR SEAL



Superior quality E.P.D.M. sponge rubber with transfer molded ends.

Convertible Pillar Seal
64-68 RH & LH CSZZ-7602626/7D
69-70 RH C9ZZ-7602626-A
69-70 LH C9ZZ-7602627-A
71-73 RH & LH D1ZZ-7602626/7A

CONVERTIBLE TOP HEADER TO WINDSHIELD SEAL



We offer this separately, for customers wanting to replace header only. Same quality as our complete kit.

Convertible Top Header To Windshield Seal
64-68 CSZZ-7653986-H
71-73 D1ZZ-7651325-A

CONVERTIBLE TOP SEAL KIT



The smart choice for the informed Mustang enthusiast. Our kit is the best, guaranteed! Don't be fooled by poor quality imitations.

Comes with installation instructions. Note: Hardware not included. See kits 379361-SK & 351320-SK.

Convertible Top Seal Kit
64-68 CSZZ-7653986-K
69-70 C9ZZ-7653986-K
71-73 D1ZZ-7653986-K

CONVERTIBLE TOP SEAL TUBE NUT SET



A very special hex tube nut that we tooled. Zinc plated.

Convertible Top Seal Tube Nut Set
64-68 Set of 16 379361-SK

CONVERTIBLE TOP SEAL WASHER SET



Exact copy, not an off the shelf generic washer. Washer is exact size and thickness.

Convertible Top Seal Washer Set
64-68 Set of 16 351320-SK

WEATHERSTRIP ADHESIVE



Supplied in five ounce tubes. From 3M.

Weatherstrip Adhesive
64-73 Yellow, not for EPDM rubber ... 3M-8001
64-73 Black, not for EPDM rubber 3M-8008
64-73 Black, for EPDM rubber 3M-8011

WELL LINERS

WELL LINER



Our well liners fit correctly. Made of heavy duty, textured vinyl. NOTE: Customers who have a 1964-1966 glass rear window will

need to use a 1967-1970 well liner.

Well Liner
64-66 Black WL-FM-65-BK
64-66 White WL-FM-65-WT
67-68 Black WL-FM-67-BK
67-68 White WL-FM-67-WT
69-70 Black WL-FM-69-BK
69-70 White WL-FM-69-WT
71-73 Black WL-FM-71-BK
71-73 White WL-FM-71-WT

WELL LINER MOUNTING SET



An 11 pc. set of flat/ phillips head screws to attach the well liner on convertibles.

Well Liner Mounting Set
64-68 377948-SMK

WELL LINER TENSIONING SPRING



Keeps the convertible well liner taut.

Well Liner Tensioning Spring
64-66 C0DB-6461883-C

COOLING SYSTEM

COOLANT CIRCULATION

DATE STAMPED RADIATOR & HEATER HOSE CLAMP SET



A must for any show, Scott Drake Radiator Hose Clamp Sets, with stamped date codes! These galvanized hose

clamps are an authentic reproduction, each clamp is stamped with the correct date code. Sold in a convenient set of 10. These are Wittek concours correct.

Radiator And Heater Hose Clamp Set, Date Stamped

64-65 6 Cyl, Stamped w/"2/64" CSZZ8287-6-2-64
64-65 V8, Stamped w/"2/64" CSZZ8287-8-2-64
65-66 6 Cyl, Stamped w/"2/65" CSZZ8287-6-2-65
65-66 V8, Stamped w/"2/65" CSZZ8287-8-2-65
67-68 6 Cyl, Stamped w/"4/66" CSZZ8287-6-4-66
67-68 SB, Stamped w/"4/66" CSZZ8287-8-4-66

NON-DATED RADIATOR & HEATER HOSE CLAMP SET



Original type post style clamps for big blocks.

Radiator And Heater Hose Clamp Set, Non-Dated
67-70 390,428 CSZZ-8287-CK

WE PROUDLY FEATURE AUTHENTIC MUSTANG REPRODUCTIONS FROM SCOTT DRAKE ENTERPRISES!



RADIATOR COOLANT FILTER

This filter is designed to be installed in the upper radiator hose. Installation of the "Full Flow" filter will stop radiator and heater core clogging due to rubber from hoses, foreign particles and rust scale. Filter is transparent and can easily be cleaned. Also available in a high performance brass version.

Radiator Coolant Filter

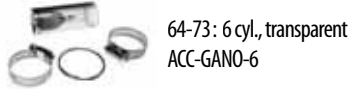

64-73: 6 cyl., transparent
ACC-GANO-6



64-73: 6 cyl., hi-po, brass
ACC-GANO-6B



64-73: 8 cyl., transparent
ACC-GANO-8



64-73: 8 cyl., alum.
ACC-GANO-8A



64-73: 8 cyl., hi-po, brass
ACC-GANO-8B



64-73: std.
ACC-GANO-HTR

CONCOURS RADIATOR HOSE SET



These are the best concourse radiator hoses on the market. New improved stamping

will not come off even when in contact with antifreeze. All have imprints that are very crisp and authentic. Each imprint is concourse correct for the specific application year.

Represented by an oval FoMoCo, rectangle FoMoCo, Autolite logo or Motorcraft.

Radiator Hose Set, Concours

64-65 260, 289 & 289 hi-po * ..C4ZE-8260/86-A
64-70 170 & 200 *C4ZE-8260/86-B
66 289 & 289 hi-po *C6ZE-8260/86-B
67 390,427 & 428 *C6OE-8260/86-A
67 289 & 289 hi-po *C7ZE-8260/86-A
68 390,427,428 & 428 Cobra Jet *
C8ZE-8260/86-C
68 289 & 302C8ZE-8260/86-E

GENERIC RADIATOR HOSE SET



Same quality as our concours radiator hose sets, but without logos and part numbers. Great for daily drivers.

Radiator Hose Set, Generic

64-68 SBC4ZE-8260/86-G

CONCOURS RADIATOR HOSE SET WITH WIRE CLAMPS



These are the best concourse radiator hoses on the market. New improved stamping

will not come off even when in contact with antifreeze. All have imprints that are very crisp and authentic. Each imprint is concourse correct for the specific application year.

Represented by an oval FoMoCo, rectangle FoMoCo, Autolite logo or Motorcraft. All feature wire clamps stapled to hoses.

Radiator Hose Set with Wire Clamps, Concours

68 390,427,428 & 428 Cobra Jet *
C8ZE-8B273/4-D
69 302, Boss 302 & 351W * C9ZE-8B273/7-B
69 302, 351W 20" *C9ZE-8B273/7-C
69-70 390,428 & 428 Cobra jet *
C9AE-8B273/4-E
69-70 Boss 429 (upper only) * C9AE-8B273/4-F
69-70 250 6 cyl. *C9ZE-8B273/7-A
70 302, Boss 302 & 351W * D0ZE-8B273/4-B
70 351 Clev. *D0ZE-8B273/4-C
71 302 *D1AE-8B273/4-A
71 351 Clev. *D1AE-8B273/4-DA
71 429 *D10E-8B273/4-BA
71 250 6 cyl. *D1ZE-8B273/4-AA
72-73 302 *D2AE-8B273/4-A
72-73 351 Clev. *D2AE-8B273/4-DA

WATER BYPASS HOSE



By-pass hose with original Ford/ Motorcraft markings.

Water Bypass Hose



64-66: FoMoCo logo*
C2DZ-8597-A



67-71: Autolite logo*
C70Z-8597-A



69-71: Motorcraft logo*
C90E-8597-D



72-73: Motorcraft logo*
D20E-8597-D

WATER PUMP



These all new pumps are the most logical way to end water pump problems. Gaskets are included with each pump.

Water Pump

64-67 260,289 cast alum.CSAZ-8501-K
64-69 SB, cast ironC50Z-8501-H
67-70 390,427,428 Cobra JetC8AZ-8501-A
70-73 351 Clev.D0AZ-8501-E
70-73 302, Boss 302, 351WD00Z-8501-A

HI-PO WATER PUMP



Built to cool better and last longer than any other pump built today. Features high efficiency impellar and NASCAR roller type

bearing. Small block aluminum unit replaces stock cast iron units.

Water Pump, Hi-Po

66-69 SB, hi-po, high flowC50Z-8501-HPA
67-70 BB, hi-po, high flowC8AZ-8501-HPA

WATER PUMP BOLT KIT



These bolts are exact copies.

Feature correct head markings and lengths. Includes

detailed instructions for the position of each bolt.

Water Pump Bolt Kit

64 260, 289, w/out ACWPB-C20E-487
64 260, 289, w/ ACWPB-C20E-491
64-70 170,200WPB-CODE-498
65 289, w/out ACWPB-C20E-388
65 289, w/ ACWPB-C50E-492
66 289, 302, w/ ACWPB-C60E-242
66-68 289, 302, w/out ACWPB-C60E-304
67 289, w/ ACWPB-C70E-249
67-70 390,428WPB-B8AE-497
68 289, 302, w/ ACWPB-C80E-305
69 302, 351W, Boss 302, w/out AC
WPB-C90E-307
69 302, 351W, w/ ACWPB-C90E-308
69-73 250WPB-C9DE-558
70-73 302, 351W, Boss 302 WPB-D00E-306
70-73 351 Clev. WPB-D00E-309
71 429 WPB-C8SE-1499

FAN SHROUD AND FAN

CLUTCH FAN BOLT

4 piece set.



Clutch Fan Bolt

66-73 C50E-1804

CAUTION FAN DECAL

Decal placed on the fan shroud to remind you to keep all ten of your fingers. Great idea for all years.

CAUTION-FAN

Decal, Caution Fan

68-69 DF-31

ELECTRIC FAN AND SHROUD KIT



This kit increases cooling capabilities especially at idle and low RPM. Tired of overheating in traffic?

This easy to install kit is not a universal kit. It is made specifically to fit all 259 radiators. No extra holes to drill. Also improves horsepower and economy. Instructions included.

Electric Fan And Shroud Kit

64-66 C3DZ-8146/8600

FAN BLADE

17 inch diameter fan improves cooling. Painted black. Not compatible with clutch fan assembly.



Fan Blade

64-73 6 Blade C6ZZ-8600-C

64-70 5 Blade C5ZZ-8600-C

64-67 4 Blade, Hi Performance ... C5ZZ-8600-HP

FAN SHROUD

An absolute must to keep you car running cool and efficient in Original steel, ABS or fiberglass.



Fan Shroud

64-66 SB, original steel..... C3DZ-8146-DR

64-66 hi-po, ABS plastic C3DZ-8146-3

64-66 hi-po, fiberglass 3 1/2" wide . C3DZ-8146-3F

67 BB, fiberglass, 24" C7ZZ-8146-A

67-69 SB w/out AC, 20" C9ZZ-8146-BR

68-69 SB w/ AC, 24" C90Z-8146-A

68-70 BB, 24", will fit 67 C8ZZ-8146-A

70 302 & 351 w/ AC. 24" D0ZZ-8146-A

70 302 & 351 w/out AC. 20" .. D0ZZ-8146-B

71-73 302 & 351 w/ AC D1ZZ-8146

FAN SHROUD BRACKET



Now made by Scott Drake. Steel brackets with a dull black finish. Mounting hardware included.

Fan Shroud Bracket

64-66 2 core C3DZ-8149-2

64-66 3 core C3DZ-8149-3

64-66 4 core C3DZ-8149-4

RADIATOR CAPS

RADIATOR CAP



These concourse quality caps are made in America and bear all the original markings. O.E.M. details include original letter style,

"S.M.C.O." and "Autolite". Pound rating is stamped on cap.

Radiator Cap

64-66 Concours, zinc C5ZZ-8100-A

64-66 Concours, chrome C5ZZ-8100-AC

67-71 Concours, zinc C7ZZ-8100-A

67-71 Concours, chrome C7ZZ-8100-AC

BILLET RADIATOR CAP



Another custom billet aluminum product from Scott Drake. We made a clear anodized aluminum top and mated it with a stock

Motorcraft™ cap. Features bright red painted "CAUTION HOT" lettering. Note that due to variations in radiator construction the words on cap may not line up perfectly.

Radiator Cap, Billet

64-73 Billet B-8100

RADIATOR CAP WITH ELECTROLYSIS PROTECTION



A special radiator cap that includes a sacrificial magnesium anode that protects aluminum and other soft material engine components from electrolysis. Electrolytic Metal Erosion (EME)

is slowly destroying your engine components. EME attacks timing chain covers, radiators, heater cores, intake manifolds, freeze plugs, head gaskets, thermostat housings even cylinder heads causing premature failures. By allowing EME to attack the sacrificial anode, the "Rad Cap" protects your engine while driving or in storage.

Radiator Cap With Electrolysis Protection

64-73 w/ sacrificial anode C5ZZ-8100-RC-E

RADIATOR MOUNTING

RADIATOR INSULATOR

Made from E.P.D.M. rubber, molded just like the original. Available in 2 row, 3 row or 4 row versions.



Radiator Insulator

67 Lower, 390 only C3AZ-8125-A

68-70 Lower C8ZZ-8125-A

67-68 Upper, 2 row C70Z-8124-A

67-68 Upper, 3 row C70Z-8124-A3

67-68 Upper, 4 row C70Z-8124-A4

RADIATOR MOUNTING BRACKET

These Brackets are made by Scott Drake from stamped steel just like the original, and built following Ford prints for an exact fit. Available in correct OEM Black (like the original), or in a highly-polished stainless steel for customers looking for a little more flash under the hood!

Radiator Mounting Bracket

67: Lower, OEM black, fits orig. radiators only - for aftermarket radiators use C8ZZ-8052-A C7ZZ-8052-A



68-70: Lower, OEM black, will fit 67 C8ZZ-8052-A



67-68: Upper, OEM black C7ZZ-8A193-A



67-68: Upper, polished stainless C7ZZ-8A193-S



69-70: Upper, OEM black C9ZZ-8A193-A



69-70: Upper, polished stainless C9ZZ-8A193-S

RADIATOR MOUNTING KIT



Black oxide finish to prevent rust. Kit includes four washer bolts and four "J" nuts. (Not for saddle mount radiators).

Radiator Mounting Kit

64-68 C5ZZ-8005-MK

WE PROUDLY FEATURE AUTHENTIC MUSTANG REPRODUCTIONS FROM SCOTT DRAKE ENTERPRISES!



RADIATORS

2 CORE, HIGH PERFORMANCE, ALUMINUM RADIATOR

New by Drake! These 2-row aluminum radiators feature extra large 1" tubes to equal 4 row efficiency, but with 5-7 lbs less weight. Benefit from improved performance through modern technology.

Radiator, 2 Core, High Performance, Aluminum



64-66: 6 cylinder, w/ tran's cooler
251-2AL



64-66: 260, 289V8, w/ tran's cooler
259-2AL



64-66: Late Model 5.0, manual
trans.
259-2AL-LM



64-66: Manual trans
259-2AL-MT



67-69: 289, 302, 351W, w/ trans
cooler 20"
340-2AL



67-70: 67-69: Late Model 5.0
70: 302 & 351C
20"
339-2AL



68-70: 390, 428 (also fits '70 302,
351), w/ tran's cooler, 24"
379-2AL

3 CORE RADIATOR



Full 2 year warranty (Limited to repair or replacement), molded foam for optimum shipping protection, all radiators are 100% pressure tested by

manufacturer, meets or exceeds original equipment specifications, long lasting satin black finish, all copper/brass core construction which resists corrosion, state of the art multi-louvered fin design which delivers maximum air flow & cooling. Note: Warranty does not include removal/installation labor or return shipping.

Radiator, 3 Core

64-66	170, 200 6 cyl.	251-3
64-66	260, 289	259-3
64-66	V8	259-3N
67-69	200 6 cyl.	329-3
67-69	289, 302, 351 w/ AC, 24"	338-3
67-69	289, 302, 351 w/out AC, 20"	340-3
67-70	67-70: 390, 428	
	70: 302, 351 w/ AC, 24"	379-3
69-70	250 6 cyl.	339-3
71-73	302, 351, 429	381-3

3 CORE, HI-FLOW RADIATOR

This radiator comes with a full 1 year warranty (limited to repair or replacement only). Brass/copper construction. Fins designed for maximum cooling. Large 1/2 inch tube diameter increases cooling flow and prevents plugging. Automatic transmission cooler included.

Radiator, 3 Core, Hi-Flow

64-66	6 cyl.	251-3HF
64-66	V8	259-3HF
67-69	200 6 cyl.	329-3HF
67-69	SB w/out AC	340-3HF
67-70	24"	338-3HF
69-70	250, 302	339-3HF

4 CORE RADIATOR

Full 2 year warranty (Limited to repair or replacement), molded foam for optimum shipping protection, all radiators are 100% pressure tested by manufacturer, meets or exceeds original equipment specifications, long lasting satin black finish, all copper/brass core construction which resists corrosion, state of the art multi-louvered fin design which delivers maximum air flow & cooling. Note: Warranty does not include removal/installation labor or return shipping.

Radiator, 4 Core

64-66	170, 200	251-4
64-66	260, 289	259-4
67-69	289, 302, & 351 w/ AC	338-4
67-69	289, 302, 351 w/out AC	340-4
68-70	All V8 w/ AC	379-4
69-70	250, 302, 351 w/out AC	339-4
71-73	302, 351, 429	381-4

RADIATOR DRAIN VALVE



These are O.E.M. replacements and will not fit most after market radiators.

Radiator Drain Valve

64-73	8A-8115
-------	---------

TEMPERATURE CONTROL

THERMOSTAT

Quality U.S.A. made.



Thermostat

64-73	190 degree, all engines	RT-1120
64-73	160 degree, 6 cyl. & SB	RT-350
64-73	180 degree, 6 cyl. & SB	RT-351

THERMOSTAT HOUSING



Super quality aluminum casting, which is made in the U.S.A. Exact copy of original, including part numbers. Also available in chrome, aftermarket.

Concours big block version will be available Spring 2009

Thermostat Housing

64-73	289 & 302 w/out smog, orig. cast alum. style	C5OE-8592-A
64-73	SB, chrome, aftermarket	C5ZZ-8592-C
67-73	BB, chrome, aftermarket	C7ZZ-8592-C
70-73	351 Clev, chrome	D0ZZ-8592-C

THERMOSTAT HOUSING BOLT



Correct headstamp.
Sold in pairs.

Thermostat Housing Bolt

64-70	6 cyl.	WNM-CODE-504
64-73	260, 289, 351W	WNM-C20E-506

THERMOSTAT HOUSING GASKET



Thermostat Housing
Gasket BY FEL-PRO®

Thermostat Housing Gasket

60-73	6 cyl. & SB	C5AZ-8255-A
67-70	390, 428	C7ZZ-8255-D
70-73	351 Clev.	C9ZZ-8255-A

WATER TEMPERATURE SENDING UNIT



Brass sensor that screws into intake manifold and activates temperature gauge in dash.

Water Temperature Sending Unit

64-66 All engines before 9/1/65 C3AZ-10884-A
66-71 200, 289, 302 & 390 after 9/1/65
C6DZ-10884-B

DECALS & STRIPING

CHASSIS, BODY AND EXTERIOR DECALS



FENDER DECAL

Identical to the factory markings

Decal, Fender

**BOSS
429**

69-70: "BOSS 429", black*
DF-225

69-70: "BOSS 429", white*
DF-226

**BOSS 351
MUSTANG**

71: "BOSS 351", black*
DF-505

71: "BOSS 351", argent*
DF-506

mach 1

71-72: "Mach 1", black*
DF-675

71-72: "Mach 1", argent*
DF-676

3" MUSTANG DECAL



A brightly colored three inch round decal featuring the famous running horse.

Decal, 3" Mustang

64-73 * DF-266

FORD BLUE OVAL DECAL



The infamous Ford blue oval on a decal.

Decal, Ford Blue Oval

64-73 3 1/2" oval* DF-361

64-73 6 1/2" oval* DF-362

64-73 9 1/2" oval* DF-363

64-73 17" oval* DF-364

FORD DRAG TEAM DECAL



Bold block letters proclaiming this car as a member of the Ford Factory Drag Team.

Decal, Ford Drag Team

64-73 5" Rectangle* DZ-115

64-73 8" Rectangle* DZ-116

GENUINE PARTS OVAL DECAL



Copy of vintage logo.

Decal, Genuine Parts Oval

64-73 3" blue oval* DF-531

KONI DECAL



The timeless Koni wings on a sticker.

Decal, Koni

64-73 DZ-112



OUTSIDE TRUNK DECAL

Decal, Outside Trunk

BOSS 351

71: Boss 351, black*

DF-507

71: Boss 351, argent*

DF-508

mach 1

71-72: Mach 1, black*

DF-677

71-72: Mach 1, argent*

DF-678

PAINT OK DECAL

These were used to confirm that the vehicles paint and trim had passed inspection.

Decal, Paint OK

P

64-73: Red "P"

DF-1157

**P T
F B**

69-71

DF-460

RAM AIR HOOD DECAL

351 RAM AIR

"RAM AIR" letters

Decal, Ram Air Hood

70 "351", black DF-383

70 "351", white DF-576

70 "428", black DF-516

70 "428", white DF-583

71 "429 RAM AIR", black DF-420

71 "429 RAM AIR", argent DF-419

71-72 "RAM AIR", black DF-385

71-72 "RAM AIR", argent DF-384

71-72 "351 RAM AIR", black DF-387

71-72 "351 RAM AIR", argent DF-386

RUNNING HORSE DECAL



Running Bar Horse Decal. Red, white, and blue bars with a silver horse.

Decal, Running Horse

64-73 5", LH* DZ-253

64-73 5", RH* DZ-254

64-73 7", LH* DZ-255

64-73 7", RH* DZ-256



SHELBY DECAL

Decal, Shelby



64-73: 3" square w/ CS logo[®]
DF-501



65-70: 2 1/4" round w/ Tiffany snake, for shock absorber[®]
DF-635



65-70: 10" round, for Shelby hi-performance equipment[®]
DZ-110



65-70: 1 5/8" x 7 1/4" w/ CS Shelby logo[®]
DZ-70

SHOCKS DECAL



Replicas of the decals that identified the shocks on the factory drag race Mustangs of 1969/70.

Decal, Shocks

69-70 Hurst shock decal set DZ-75

WE PROUDLY FEATURE AUTHENTIC MUSTANG REPRODUCTIONS FROM SCOTT DRAKE ENTERPRISES!



USA BODY SHIELD DECAL



This decal went on the rear of the quarter panel of the 1972 Olympic Sprint convertible of which only fifty were produced

Decal, USA Body Shield

72 DF-388

WHEEL CENTER DECAL



Decal, Wheel Center



65-67: Wire wheel, blue*
DF-533



66: Shelby Hertz car club
DF-587



66: Shelby 5 spoke wheel center*
DF-588

DECAL KITS

DECAL KIT



Great Detailing Aid. These Kits include all the common decals. Air Cleaner & AC

Decal are not included.

Decal Kit

64 *DK-24
65 *DK-25
66 *DK-26
67 *DK-27
68 *DK-28
69 *DK-29
70 *DK-30
71 *DK-31
72 *DK-32
73 *DK-33

EMISSION DECALS

EMISSIONS DECAL



This decal shows that this vehicle complied with emission regulations.



Decal, Emissions

68	GT 500, GT 350 *	DF-341
68-69	SB, 2V *	DF-296
68-69	BB, 4V *	DF-297
68-69	302, 351, 4V *	DF-562
69	GT 390, 4V *	DF-782
69-70	GT 500 *	DF-174
69-70	GT 350 *	DF-175
69-70	Boss 302 *	DF-197
69-70	Boss 429 *	DF-295
70	200 6 cyl. *	DF-311
70	Boss 302, late 1970 *	DF-344
70	Boss 302, manual *	DF-650
70	351, 4V *	DF-742
70	200 6 cyl. *	DF-772
71	Boss 351, manual *	DF-455
71	351 Clev., 4V *	DF-534
71	351, 2V *	DF-554
71	429 Cobra Jet, 4V *	DF-555
71	351, 4V, manual *	DF-582
71	200 6 cyl. *	DF-666
71	302, 2V *	DF-763
72	351 Clev., 2V *	DF-594
73	351 Clev., 4V *	DF-638
73	351 Clev., 2V, auto. *	DF-640
73	302, 2V *	DF-641

ENGINE COMPARTMENT DECALS

AIR CONDITIONING DECAL



Decal, Air Conditioning

64-66	AC sight glass *	DF-1130
64-66	AC Dryer *	DF-550
64-70	AC alum. tag *	DF-351
67-68	AC Dryer *	DF-153
67-70	AC clutch *	DF-548
69	AC Dryer *	DF-656
70	AC Dryer *	DF-549
71-73	AC charge mounts on radiator support *	DF-532

AIR CLEANER DECAL



Identical to the factory decal that designated engine and

carburetor size as well as service instructions.

Decal, Air Cleaner

64	260 CID *	DF-45
64-65	Service *	DF-83
64-66	Vent	DF-350
64-67	289 hi-po *	DF-15
64-68	Air cleaner, 8 cyl. *	DF-160
64-68	Air cleaner, 6 cyl. *	DF-352
64-73	Front	DF-150
65	170 CID *	DF-95
65-66	289-2V *	DF-13
65-66	289-4V *	DF-14
65-68	200 CID *	DF-59
65-70	Ventra Flow	DF-477
66	200 CID Sprint *	DF-171
66	Part Number	DF-37
66-73	Service *	DF-149
67	Part Number	DF-261
67	Cobra *	DF-744
67-68	289-2V *	DF-104
67-68	289-4V *	DF-105
67-68	Sports Sprint	DF-246
67-68	390 hi-po *	DF-322
67-69	390 CID *	DF-53
67-69	390 4V, premium fuel *	DF-54
68	428-4V, premium fuel *	DF-221
68	427-4V, premium fuel *	DF-316
68	427 4V hi-po *	DF-324
68-69	302 hi-po *	DF-321
68-69	250 CID *	DF-443
68-69	302-2V *	DF-60
68-69	302-4V, premium fuel *	DF-61
69	Boss 302 *	DF-162
69	351-2V *	DF-62
69	351-4V, premium fuel *	DF-63
69	428 *	DF-778
69-70	Cobra Jet Ram Air *	DF-178
69-70	351 Ram Air *	DF-179
69-70	428 Cobra Jet *	DF-379
70	250 CID *	DF-172
70-71	302 2V, regular fuel *	DF-182
70-71	302-4V, premium fuel *	DF-183
70-71	351-2V, regular fuel *	DF-184
70-71	351-4V, premium fuel *	DF-185
70-71	390-4V, premium fuel *	DF-479
71	429-4V, regular fuel *	DF-181
71	Boss 351 *	DF-260
71	429 Cobra Jet *	DF-395
71	429-4V, premium fuel *	DF-451
71-73	351-2V, regular fuel *	DF-668
72	351 Cobra Jet *	DF-365
72	351 HO *	DF-553
72-73	302-4V, premium fuel *	DF-254
72-73	351-2V, regular fuel *	DF-255
72-73	351-4V, regular fuel *	DF-256
72-73	302-2V, regular fuel *	DF-584
72-73	250 1V *	DF-643

AUTOLITE DECAL



Various vintage Autolite decals.

64-68	Air cleaner, 8 cyl. *	DF-160
64-68	Air cleaner, 6 cyl. *	DF-352
64-70	FL-1 oil filter *	DF-684
64-70	F-11 racing oil filter *	DF-783
64-72	Sta-ful battery tag *	DF-784
64-73	Autolite/Ford, 1/2"X 2 1/2" Rectangle * ..	DZ-120
64-73	5"GT-40 rectangle *	DZ-122
64-73	8"GT-40 rectangle *	DZ-123
64-73	Autolite spark plugs, 6.5" round *	DZ-4
64-73	Autolite spark plugs, 4" round *	DZ-5
67-70	Fuel filter *	DF-1123
68-75	Air Cleaner *	DF-325

BATTERY DECAL

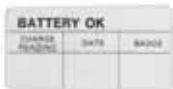

This decal informed the buyer that the battery was checked and was certified to be OK.

64	DF-405
64-70	DF-194

CAUTION FAN DECAL



Decal placed on the fan shroud to remind you to keep all ten of your fingers.

68-69	DF-31
-------	-------

COIL DECAL



Makes coil look more authentic.

64	DF-33
65-72	DF-224
72-73	DF-715

COOLANT WARNING DECAL



Decal supplied to inform owner of cooling system requirements.

64-66	DF-250
-------	--------

DISC BRAKE MASTER CYLINDER DECAL



Advised owner of the proper brake fluid for each vehicle.

66	DF-331
67	DF-332

FORD 6000 MILE OR 6 MO. LUBE DECAL



64-73	DF-746
-------	--------

FUEL FILTER DECAL



A decal supplied with the fuel filter on all cars.

64-66	DF-280
-------	--------

GENERATOR DECAL



This decal was on the generator to insure proper fitment.

64	DF-515
----	--------

MOTORCRAFT DECAL



Motorcraft GT 40 sticker with the famous Speeding racer.

64-73	DZ-121
-------	--------

OIL FILLER CAP DECAL



This decal was put on the oil cap to alert the owner about the recommended

64-66	DF-164
-------	--------

OIL FILTER DECAL

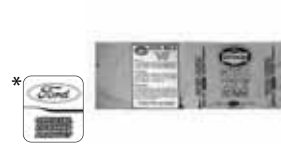

Decals to go on a regular oil filter to give the appearance of a vintage Ford filter.

64-67	DF-613
64-67	DF-647

SERVICE SPECIFICATION DECAL



This sticker was used to alert the owner of regular service schedules.

64	DF-345
65-66	DF-20
67-69	DF-52
70	DF-346
71	DF-308

STARTER DECAL



This decal was put on the starter to assure proper fitment.

64	DF-447
----	--------

VALVE COVER DECAL



64-73	DF-410
64-73	DF-411
65-67	DF-373
69-70	DF-138
69-70	DF-176
71	DF-394

VOLTAGE REGULATOR DECAL



This was put on each voltage regulator to inform that it was the correct part.

64-66	DF-347
65-66	DF-412
65-70	DF-320
67	DF-348
68-71	DF-464
72-73	DF-714

WE PROUDLY FEATURE AUTHENTIC MUSTANG REPRODUCTIONS FROM SCOTT DRAKE ENTERPRISES!



ANTIFREEZE TAG



A tag attached to the radiator that explains service procedures.

Tag, Antifreeze

64-66 Rotunda*	DF-699
64-70 FoMoCo*	DF-120
67-73 Ford*	DF-700

INTERIOR DECALS

BUILD SHEET



A blank build sheet to make your classic appear more complete. This is not a Ford product and is not implied to be original.

Build Sheet

64-65	DF-723
66	DF-1106
67	DF-1384
68	DF-787
69	DF-786
70	DF-785

HEADLIGHT AIM ADJUSTER CARD



Instructions to keep the lights aimed properly.

Card, Headlight Aim Adjuster

69	DF-725
----	--------

SHELBY DEALER INVOICE



A sheet that showed the dealer invoice.



Dealer Invoice, Shelby

65 Shelby [§]	DF-669
------------------------	--------

BOSS AND SHELBY CHOKE DECAL



A decal that explains the use of the manual choke.

Decal, Boss And Shelby Choke

69-70	DF-644
-------	--------

LOCKING DIFFERENTIAL DECAL



Notifies owner that this car is equipped with a locking differential. Detroit locker only.

Decal, Locking Differential

65-66 Shelby	DF-578
65-73 Glove box	DF-429

MUSTANG OIL SERVICE DECAL



These static cling service reminders are available in four classic Ford designs.

Each feature authentic four color logo designs. Install on windshield or door jam, easily removed without any residue or harm to surface. Helpful reminder whether you change your oil yourself or have your mechanic do it. Gives your car that personalized touch of detail that others will envy. Packaged 6 per container in our new custom designed reclosable clear plastic clam shell. Mix OSR's to achieve lot requirements

Decal, Mustang Oil Service



64-73: Mustang logo[§]
OS-1



64-73: Shelby logo[§]
OS-2



65-70: Cobra logo[§]
OS-4



69-70: 302 logo[§]
OS-3

RADIO REVERBERATION DECAL

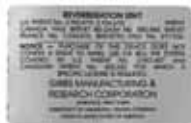

A decal for the radio telling of reverb option

Decal, Radio Reverberation

64-66	DF-651
-------	--------

REV LIMITER DECAL



Autolite 6950
ENG GOV 6150 RPM
DQZF-12450-B

A decal that warned that the car was equipped with a rev-limiter or governor.

Decal, Rev Limiter

69-70 *	DF-319
---------	--------

SHELBY DASH DECAL



COBRA JET GT 500

A nice reproduction of the decal that went on the dash.

Decal, Shelby Dash

69-70 GT 350 [§]	DF-196
69-70 GT 500 [§]	DF-298

SHELBY FOG LIGHT & INTERIOR CONSOLE DECAL



Decal for fog light and interior light switch.

Decal, Shelby Fog Light And Interior Console

69-70	DF-173
-------	--------

STEREO DOOR SPEAKER DECAL



Stereo script to go on speakers.

Decal, Stereo Door Speaker

69-70	DF-577
-------	--------

SUN VISOR SEAT BELT DECAL



Shelby Sun Visor Seat Belt Decal and the small silver snake decal supplied on the buckle of Shelby seat belts.

Decal, Sun Visor Seat Belt

67-70	DF-343
-------	--------

TIRE PRESSURE DECAL



A Ford licensed product, this decal gives loads of information about your cars original tires.

Decal, Tire Pressure

65-66 For cars w/"Red Ring" sidewalls*	DF-463
66 *	DF-19
67-68 Shelby, high speed	DF-158
67-68 *	DF-282
67-68 Shelby [§]	DF-586
68 Door*	DF-283
69 Early 1969*	DF-559
69 Late 1969*	DF-376
69-70 Shelby, glove box [§]	DF-137
69-70 Glove box*	DF-310
70 Door*	DF-1004
70 Early 1970*	DF-789
70 Late 1970*	DF-147
71 *	DF-377
72 *	DF-380
73 *	DF-378

SHELBY SEAT BELT INSERT EMBLEM



They are the most authentic and best looking emblems available.

Emblem, Shelby Seat Belt Insert



67: Shelby Cobra[®]
S7MS-63611A73-A



68: Shelby Cobra, gold[®]
S8MS-63611A73-A



69-70: Shelby[®]
DF-306



69-70: Shelby[®]
S9MS-63611A73-A

IGNITION LOCK SLEEVE INSTRUCTION



Instructions for starting your new Mustang.

Instruction, Ignition Lock Sleeve

70 DF-726

SUN VISOR STARTING INSTRUCTION SLEEVE



Instructions showing how to start your Mustang.

Instruction Sleeve, Sun Visor Starting

64-70 * DF-170

NEW CAR WINDOW PRICE STICKER



Price Sticker, New Car Window

64	*	DF-595
65	*	DF-43
66	Shelby [®]	DF-123
66	*	DF-25
67	*	DF-124
67	GT 500 [®]	DF-227
67	GT 350 [®]	DF-228
68	Shelby [®]	DF-200
69	*	DF-88
69-70	Shelby [®]	DF-328
70	*	DF-240
71	*	DF-87
72	*	DF-264
73	*	DF-243

3 SPEED MANUAL TRANMISSION

INSTRUCTION TAG

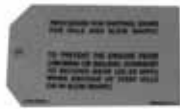

A tag that explains shifting procedure on hills or traffic. For 3 speed cars.

Tag, 3 Speed Manual Transmission Instruction

67-68 DF-649

CAUTION DRIVEN INSTRUCTION TAG



This decal was supplied to instruct the owner that the car should be driven regularly to keep components working properly.

Tag, Caution Driven Instruction

64-69 DF-208

DISC BRAKE WARNING TAG

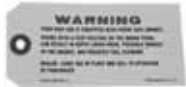

A warning tag that shows proper use and care of disc brakes.

Tag, Disc Brake Warning

65 DF-729

HEATER INSTRUCTION TAG



A paper tag that was hanging from the heater knob when you bought the car.

Tag, Heater Instruction

64 DF-51
65-66 DF-564

NOVELTY WARNING TAG



A fun tag for your Shelby GT that warns of the consequences of driving near pretty girls.

Tag, Novelty Warning

65-70 Shelby GT 350 DF-625
67-70 Shelby GT 500 DF-626

SEAT BELT RETRACTOR TAG



A tag supplied with cars to explain the proper way to use the retractable seat belts.

Tag, Seat Belt Retractor

64-67 DF-305

WINDSHIELD WASHER ADJUSTER TAG



Tag, Windshield Washer Adjuster

65-66 DF-444

PRE-DELIVERY DECALS

SHELBY PRE-DELIVERY SHEET



This sheet was given to the buyer at the dealership to show that his new Shelby had

gone through a series of checks and tests.

Pre-Delivery Sheet, Shelby

66	GT 350 [®]	DF-660
67	GT 350 [®]	DF-661
68	[®]	DF-476
69	[®]	DF-663
70	[®]	DF-664

STRIPES

GT STENCIL KIT



Stencil kit or patterns to install GT stripe kit, Mustang letters and Mustang emblems.

Stencil Kit, GT

65-66 MSK001

BOSS 302 STRIPE KIT



Excellent quality automotive grade vinyls. All of our stripe kits have special agents added for U.V.

protection. Mill thicknesses are equal to the original O.E. stripes
Stripe Kit, Boss 302

 69: Black^{*}
C9Z-6320000-V

 69: White^{*}
C9Z-6320000-W

 70: Black^{*}
D0Z-6320000-C

Decals/Stripes

WE PROUDLY FEATURE AUTHENTIC MUSTANG REPRODUCTIONS FROM SCOTT DRAKE ENTERPRISES!



C STRIPE KIT



Our quality reproduction stripe kits come with installation instructions, squeegee.

Excellent quality automotive grade vinyls. All of our stripe kits have special agents added for U.V. protection. Mill thicknesses are equal to the original O.E. stripes Individually boxed.

Stripe Kit, C

68	Black	C8ZZ-6520000-A
68	White	C8ZZ-6520000-B
68	Red	C8ZZ-6520000-C
68	Blue	C8ZZ-6520000-D
68	Gold	C8ZZ-6520000-E
68	Reflective Gold	C8ZZ-6520000-R

CALIFORNIA SPECIAL STRIPE KIT



Our quality reproduction stripe kits come with installation instructions, squeegee. Individually boxed.

Stripe Kit, California Special

68	Black*	C8ZX-16224-A
68	White*	C8ZX-16224-B
68	Red*	C8ZX-16224-C
68	Blue*	C8ZX-16224-D
68	Gold*	C8ZX-16224-G

GT STRIPE KIT



Our quality reproduction stripe kits come with installation instructions, squeegee.

Excellent quality automotive grade vinyls. All of our stripe kits have special agents added for U.V. protection. Mill thicknesses are equal to the original O.E. stripes Individually boxed.

Stripe Kit, GT

65-66	Black	C5ZZ-6520000-A
65-66	White	C5ZZ-6520000-B
65-66	Red	C5ZZ-6520000-C
65-66	Blue	C5ZZ-6520000-D
67	Black	C7ZZ-6520000-A
67	White	C7ZZ-6520000-B
67	Red	C7ZZ-6520000-C
67	Blue	C7ZZ-6520000-D
69	Black	C9ZZ-6520000-A
69	White	C9ZZ-6520000-B
69	Red	C9ZZ-6520000-C
69	Blue	C9ZZ-6520000-D
69	Gold	C9ZZ-6520000-E

MACH 1/BOSS 351/RALLY STRIPE KIT



Excellent quality automotive grade vinyls. All of our stripe kits have special agents added for U.V. protection. Mill thicknesses are equal to the original O.E. stripes. Mach 1 kits include trunk stripe.

Stripe Kit, Mach 1/Boss 351/Rally



69: Mach 1, Black/Gold*
C9ZZ-6320000-A
69: Mach 1, Red/Gold*
C9ZZ-6320000-C



69: Mach 1, Gold/White*
C9ZZ-6320000-G
71-72: Boss, Rally, black, side stripe only
D1ZZ-6320000-A
71-72: Boss, Rally, argent, side stripe only
D1ZZ-6320000-R



73: Mach 1, Argent*
D3ZZ-6320000-A
73: Mach 1, Black*
D3ZZ-6320000-BK

SHELBY STRIPE KIT



Our quality reproduction stripe kits come with installation instructions, squeegee. Individually boxed.

Stripe Kit, Shelby

65	Blue	S1MS-16224-B
66	Hertz gold	S2MS-16224-G
66-68	Black GT350	S2MS-16224-A
66-68	White GT350	S2MS-16224-B
66-68	Red GT350	S2MS-16224-C
66-68	Blue GT350	S2MS-16224-D
67-68	Black GT500	S7MS-16224-A
67-68	White GT500	S7MS-16224-B
69-70	Black*	S9MS-16224-A
69-70	White*	S9MS-16224-B
69-70	White*	S9MS-16224-C
69-70	Gold*	S9MS-16224-E

* Special order, specify body style and engine size

DEARBORN HOOD STRIPE STENCIL



A stencil kit to help you get those stripes straight when repainting the hood.

Stripe Stencil, Dearborn Hood

70	351 For hood*	GE-811-351
70	428 For hood*	GE-811-428

SHAKER HOOD STRIPE STENCIL



A stencil kit to help you get those stripes straight when repainting the hood.

Stripe Stencil, Shaker Hood

70	351 For hood*	GE-812-351
70	428 For hood*	GE-812-428

TRUNK LID STRIPE KIT



Excellent quality automotive grade vinyls. All of our stripe kits have special agents added for U.V. protection. Mill thicknesses are equal to the original O.E. stripes

Stripe Kit, Trunk Lid



70: Mach 1, white*
SK-008



70: Mach 1, black*
SK-009

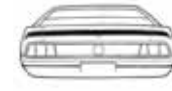

71: Boss 351, black*
SK-012



71: Boss 351, argent*
SK-013



71-72: Mach 1, black*
SK-010

71-72: Mach 1, argent*
SK-011

73: Mach 1, argent*
SK-023

73: Mach 1, black*
SK-024

TRUNK COMPARTMENT DECALS

JACK INSTRUCTION DECAL



Instructions for the use and stowage of the stock jack.

Decal, Jack Instruction

65	DF-145
66	DF-146
67	Early 1967	DF-371
67-68	Late 1967, & 1968	DF-44
68	Styled steel wheel	DF-374
68-70	Space saver	DF-368
69-70	Styled wheel	DF-77
69-70	Regular wheel	DF-78
71	Space saver spare, late 1971	DF-218
71	Space saver	DF-367
71	Regular wheel, early 1971	DF-46
71-72	Regular wheel, 1971/72	DF-413
71-72	Space saver	DF-414
73	CV	DF-465
73	CP	DF-653

FORD SAFETY ACT DECAL

This decal assured that your new car complied with federal safety laws when it was delivered to the customer.
Decal, Ford Safety Act



66-68
DF-665



68-69
DF-168

SHELBY SAFETY ACT DECAL



This decal was supplied to assure that the car complied with federal safety regulations.

Decal, Shelby Safety Act

68-69 * DF-169

SPACE SAVER INFLATION BOTTLE DECAL



Original inflation instructions for the space saver "inflator" bottle.

Decal, Space Saver Inflation Bottle

68 * DF-811
69 * DF-812
70 * DF-813
71-73 * DF-814

SPACE SAVER SPARE INSTRUCTION DECAL



Safety instructions for the proper use and storage of the space saver spare tire.

Decal, Space Saver Spare Instruction

68-70 DF-244

SPACE SAVER TRUNK LID DECAL



This decal explains the use and storage of the space saver spare tire and wheel.

Decal, Space Saver Trunk Lid

68-70 * DF-281

B.F. GOODRICH SPACE SAVER POSTCARD



A post card that was sent to owners of cars equipped with space saver tires to warn of possible problems.

Postcard, B.F. Goodrich Space Saver

68-71 DF-807

WINDOW DECALS

5.0 LITER H.O. WINDOW DECAL



Stick-on decal featuring "5.0 Liter H.O."

Window Decal, 5.0 Liter H.O.

64-73 "5.0 Liter H.O." white ACC-09WD-W

COBRA WINDOW DECAL



These self-adhesive decals look great on your front or back windshield or just about anywhere around the home or shop. 3 different cobra styles to choose from.

Window Decal, Cobra



64-73: Tall cobra, red, 19" x 14"
ACC-14WD-R

64-73: Tall cobra, white, 19" x 14"
ACC-14WD-W



64-73: Short cobra, red, 15" x 24"
ACC-15WD-R

64-73: Short cobra, white, 15" x 24"
ACC-15WD-W



64-73: "Cobra Jet" w/ burning wheels^s
DF-393



64-73: "Cobra" w/ burning wheels^s
DF-822

MUSCLE POWER WINDOW DECAL



A brightly colored sticker that is reminiscent of the 70's flower power theme.

Window Decal, Muscle Power

64-73 For inside window DZ-113

64-73 For outside window DZ-114

MUSTANG WINDOW DECAL



These self-adhesive decals look great on your front

or back windshield or just about anywhere around the home or shop.

Window Decal, Mustang

64-73 Red, 3" X 23" * ACC-05WD-R

64-73 White, 3" X 23" * ACC-05WD-W

MUSTANG SCRIPT WINDOW DECAL



These self-adhesive decals look

great on your front or back windshield or just about anywhere around the home or shop.

Window Decal, Mustang Script

64-73 Red, 3" X 19" * ACC-06WD-R

64-73 White, 3" x 19" * ACC-06-WD-W

PRODUCTION DAY WINDOW DECAL



This decal was used to tell what day the car was produced.

Window Decal, Production Day

64-75 Day 7 DF-1012

RUNNING HORSE WINDOW DECAL



These self-adhesive decals look great on your front or back windshield

or just about anywhere around the home or shop.

Window Decal, Running Horse

64-73 Red, 13" x 34" * ACC-13WD-R

64-73 White, 13" x 34" * ACC-13WD-W

DOORS PARTS

ARMRESTS

ARM REST BASE



Precision molded of stress-resistant plastic, with a smooth durable chrome finish.

Arm Rest Base

64-66 C5Z-6524144-A

ARM REST BASE AND PAD KIT



Each kit contains a pair of arm rest pads and bases. Arm rest pads feature correct texture and molded in color. Steel insert

for strength. Extra thick vinyl skin. Base is precision molded of stress resistant plastic with a smooth chrome finish. Kit includes all mounting hardware.

Arm Rest Base and Pad Kit

64-66 Black KIT-INT-2-BK

64-66 Medium blue KIT-INT-2-BL

64-65 Bright red KIT-INT-2-BR

66 Dark blue KIT-INT-2-DB

66 Dark red KIT-INT-2-DR

64-65 White KIT-INT-2-WT

Door Parts

WE PROUDLY FEATURE AUTHENTIC MUSTANG REPRODUCTIONS FROM SCOTT DRAKE ENTERPRISES!



1964-66 ARM REST PAD



Correct texture and molded-in colors, with steel insert molded into foam to increase strength. Extra thick vinyl skins. American made.

Arm Rest Pad, 1964-66

64-66	Black	C5ZZ-6524100-BK
66	Aqua	C5ZZ-6524100-AQ
64-65	Medium blue	C5ZZ-6524100-BL
64-65	Bright red	C5ZZ-6524100-BR
66	Dark blue	C5ZZ-6524100-DB
66	Dark red	C5ZZ-6524100-DR
64-66	Ivy gold	C5ZZ-6524100-IG
64-65	Palomino	C5ZZ-6524100-PA
66	Parchment	C5ZZ-6524100-PR
64-65	White	C5ZZ-6524100-WT

1967 ARM REST PAD



Correct texture and molded-in colors, with steel insert molded into foam to increase strength.

Extra thick vinyl skins. American made.

Arm Rest Pad, 1967

67	Black	C7ZZ-6524100-BK
67	Red	C7ZZ-6524100-RD
67	Blue	C7ZZ-6524100-BL
67	Aqua	C7ZZ-6524100-AQ
67	Ivy gold	C7ZZ-6524100-IG
67	Parchment	C7ZZ-6524100-PR
67	Saddle	C7ZZ-6524100-SA

1968 ARM REST PAD



Correct texture and molded-in colors, with steel insert molded into foam to increase strength. Extra thick vinyl skins. American made.

Arm Rest Pad, 1968

68	Black, RH	C8ZZ-6524100-BK
68	Black, LH	C8ZZ-6524101-BK
68	Red, RH	C8ZZ-6524100-RD
68	Red, LH	C8ZZ-6524101-RD
68	Blue, RH	C8ZZ-6524100-BL
68	Blue, LH	C8ZZ-6524101-BL
68	Aqua, RH	C8ZZ-6524100-AQ
68	Aqua, LH	C8ZZ-6524101-AQ
68	Ivy gold, RH	C8ZZ-6524100-IG
68	Ivy gold, LH	C8ZZ-6524101-IG
68	Parchment, RH	C8ZZ-6524100-PR
68	Parchment, LH	C8ZZ-6524101-PR
68	Saddle, RH	C8ZZ-6524100-SA
68	Saddle, LH	C8ZZ-6524101-SA

1968 DELUXE ARM REST PAD



Correct texture and molded-in colors, with steel insert molded into foam to increase strength. Extra thick vinyl skins. American made.

Arm Rest Pad, 1968 Deluxe

68	Black, RH	C8ZZ-6524100BKD
68	Black, LH	C8ZZ-6524101BKD
68	Blue, RH	C8ZZ-6524100BLD
68	Blue, LH	C8ZZ-6524101BLD
68	Aqua, RH	C8ZZ-6524100AQD
68	Aqua, LH	C8ZZ-6524101AQD
68	Ivy gold, RH	C8ZZ-6524100IGD
68	Ivy gold, LH	C8ZZ-6524101IGD
68	Maroon, RH	C8ZZ-6524100MRD
68	Maroon, LH	C8ZZ-6524101MRD
68	Parchment, RH	C8ZZ-6524100PRD
68	Parchment, LH	C8ZZ-6524101PRD
68	Saddle, RH	C8ZZ-6524100SAD
68	Saddle, LH	C8ZZ-6524101SAD

1969-70 ARM REST PAD



Correct texture and molded-in colors, with steel insert molded into foam to increase

strength. Extra thick vinyl skins. American made. *Note: Ford used 2 different arm rest pads in 69-70. We currently offer only 1 version. Mounting holes are approximately 12 1/4" from center to center on our pads. Some cars require relocating one mounting hole before door panel is installed.*

Arm Rest Pad, 1969-70

69-70	Black, RH	C9ZZ-6524100-BK
69-70	Black, LH	C9ZZ-6524101-BK
69-70	White, RH	C9ZZ-6524100-WT
69-70	White, LH	C9ZZ-6524101-WT

1971-73 ARM REST PAD



Correct texture and molded-in colors, with steel insert molded into foam to increase strength. Extra thick

vinyl skins. American made.

Arm Rest Pad, 1971-73

71-73	Black, RH	D1ZZ-6524100-BK
71-73	Black, LH	D1ZZ-6524101-BK
71-73	Blue, RH	D1ZZ-6524100-BL
71-73	Blue, LH	D1ZZ-6524101-BL
71-73	Ginger, RH	D1ZZ-6524100-GI
71-73	Ginger, LH	D1ZZ-6524101-GI

ARM REST PLUG



Perfect detail in these often missing plugs.

Arm Rest Plug

67	Black, dlx.	C7ZZ-6524056-BK
67	Parchment, dlx.	C7ZZ-6524056-PR
68	Black, dlx., set of 4	C8ZZ-6524056-BK
68	Parchment, dlx., set of 4	C8ZZ-6524056-PR

DOOR HANDLES & WINDOW CRANKS, INSIDE

INSIDE DOOR HANDLE

Excellent reproductions of the originals, fit is perfect. All of these handles feature a brightly polished, chrome finish or our custom satin chrome finish.

Door Handle, Inside



64-65: Early 65, RH or LH
C3AZ-6222600-B



65-67: Late 65, RH or LH
CSZZ-6522600-C



65-66: dlx., RH
CSZZ-6522600-A



65-66: dlx., LH
CSZZ-6522601-A



68: RH
C7AZ-5422600-B

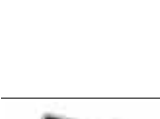

68: LH
C7AZ-5422601-B



68: RH, satin
C7AZ-5422600-S



68: LH, satin
C7AZ-5422601-S



69-70: RH
C9AZ-6222600-A



69-70: LH
C9AZ-6222601-A

71-73: dlx., RH
D1ZZ-6522600-A

71-73: dlx., LH
D1ZZ-6522601-A

INSIDE DOOR HANDLE & WINDOW CRANK KIT



Kit includes clip or screw-on door handles, window cranks, quarter window cranks (for coupe and convertible), clips/screws and backing plates.

Door Handle & Window Crank Kit, Inside

64-65	Early 65 CP or CV, chromeKIT-DH-2
65	Early 65 FB, chromeKIT-DH-1
65-67	Late 65 FB, chromeKIT-DH-3
65-67	Late 65 FB, satinKIT-DH-3S
65-67	Late 65 CP or CV, chromeKIT-DH-4
65-67	Late 65 CP or CV, satinKIT-DH-4S
68	FB, chromeKIT-DH-7
68	CP or CV, chromeKIT-DH-8

DOOR WINDOW CRANK

Highly detailed die-cast zinc construction. Finished in beautiful chrome or satin chrome. Our handle feature much better detail than others.

Window Crank, Door



64-65: Early 65, chrome
C4SZ-6323342-A



65-67: Late 65, chrome
C5ZZ-6523342-C



68-70: Chrome
C8AZ-6223342-A



68-70: Satin chrome
C8AZ-6223342-S

QUARTER WINDOW CRANK

Quarter window crank handle, made by Scott Drake. Like all our handles, these feature better detail and better chrome than competitors.

Window Crank, Quarter



64-65: Early 65, chrome
C4SZ-6530322-A



65-67: Late 65, chrome
C5ZZ-6530322-A



68-70: Chrome
C8ZZ-6530322-A

DELUXE WINDOW CRANK & DOOR HANDLE BACKING PLATE



Die cast and chrome plated. New improved design is very wear resistant. Also included are nylon bushings to prevent scratches.

Window Crank & Door Handle Backing Plate, Deluxe
65-66C4SY-6322620/1A

WHITE, INSIDE WINDOW CRANK & DOOR HANDLE BACKING PLATE



Protects door panels from the abrasive action of rotating handles. Made from a very hard nylon type material. Ours feature

the correct milky white color.
Window Crank & Door Handle Backing Plate, White, Inside
64 DoorC3AZ-6223370-A
65-70 DoorC5AZ-6223370-A
64-67 Quarter windowC4SZ-6323370-A
68-73 DoorC8AZ-6223370-A

CHROME, INSIDE WINDOW CRANK BACKING PLATE



The original plates are either missing, cracked or no longer chrome. Our plates are made with a bright chrome finish to really catch

the eye.
Window Crank Backing Plate, Chrome, Inside
69-70 ChromeC9ZZ-6523370-A

INSIDE DOOR HANDLE & WINDOW CRANK SCREW

We have these exact reproductions made especially for us. You want to use right parts, not something "close". 65-66 are chrome plated just like the originals. Sold in sets of 4.

Door Handle & Window Crank Screw, Inside



65-66: Set of 4
379259-S



67-70: Set of 4
381571-S

DOOR HANDLE & WINDOW CRANK SPRING



Black lacquer finished to prevent rust. Fits behind door panel

Door Handle & Window Crank Spring
64-67B7A-7022624-A

DOOR HANDLE CLIP REMOVER



Removes special retaining clip on early door handles and window cranks. Stamped steel construction.

Door Handle Clip Remover
64-65T-87600

DOOR HANDLE SPRING CLIP



Small spring clip, copper plated just like the originals. Used to attach door handle and window crank to door shaft.

Door Handle Spring Clip
64-65357550-S

WINDOW CRANK HANDLE COVER PLATE



This is a aluminum disc that covers the window crank handle screw hole. Stamped aluminum with circular brushed finish and

adhesive backed.
Window Crank Handle Cover Plate
68-73C8AZ-6223362-A

WINDOW CRANK KNOB



A premium reproduction. The knob is vinyl-molded and has a plastic insert just like the original. Mounting

pin and wave washer are also included.
Window Crank Knob

68-73	BlackC8AZ-6223352-BK
68-70	Clear/SilverC8AZ-6223352-CL
68-70	Ivy goldC8AZ-6223352-IG
68-70	MaroonC8AZ-6223352-MR
68-73	BlueC8AZ-6223352-BL
68-73	GingerC8AZ-6223352-GI
68-73	GreenC8AZ-6223352-GR
68-73	Parchment & nugget goldC8AZ-6223352-PR
68-73	VermillionC8AZ-6223352-VE
68-73	WhiteC8AZ-6223352-WT

Door Parts

WE PROUDLY FEATURE AUTHENTIC MUSTANG REPRODUCTIONS FROM SCOTT DRAKE ENTERPRISES!



DOOR HANDLES, OUTSIDE

OUTSIDE DOOR HANDLE



Our door handles are now available in 3 finishes: polished chrome, satin chrome, and black

chrome. Our 64-70 handles come in kits that include both left and right handles, buttons, pads, hardware and brackets.

Door Handle, Outside

64-70 Economy, chrome Fits: 64-66, 69-70	C4DZ-622404/5A
64-66 Show-quality, chrome	C4DZ-622404/5P
64-66 Show-quality, satin chrome	C4DZ-622404/5S
64-66 Show-quality, black chrome	C4DZ-622404/5B
67-68 Economy, chrome	C7ZZ-6522404/5A
67-68 Show-quality, chrome	C7ZZ-6522404/5P
67-68 Show-quality, satin chrome	C7ZZ-6522404/5S
67-68 Show-quality, black chrome	C7ZZ-6522404/5B
69-70 Show-quality, chrome	C9ZZ-622404/5P
69-70 Show-quality, satin chrome	C9ZZ-622404/5S
71-73 Chrome, LH & RH	D1ZZ-622404/5A

OUTSIDE DOOR HANDLE PAD



Fit between door handle and door body panel. Injection-molded plastic just like the original. Sold in complete sets only. 4 piece sets.

Outside Door Handle Pad

64-70 Does not fit 67-68	CODZ-6422428/9K
67-68	C7ZZ-6522428/9K

DOOR HINGES

DOOR HINGE BUSHING



Machined brass to original factory specs. Requires 2 per pin.

Door Hinge Bushing

64-70	C3AZ-5422841-A
-------------	----------------

DOOR HINGE PIN



Machined just like the original.

Door Hinge Pin

64-68 2 1/2"	B9A-5943030-AA
64-73 Long, cut to fit	B9A-5943030-LG

DOOR HINGE REPAIR KIT



Contains all necessary parts including pins, bushings, a new cam plate, spring, and roller to rebuild both upper and lower hinges.

Door Hinge Repair Kit

64-67	C5ZZ-6522800-K
-------------	----------------

DOOR HINGE REPAIR SPRING



Spring to reload tension in door hinge. Compression tool also available.

Door Hinge Repair Spring

64-68	CODZ-6421232-B
-------------	----------------

DOOR HINGE



Reproduction cast iron hinges that look and work right. Painted black.

Door Hinge

64-66 RH, upper	C5ZZ-6522800-BR
64-66 LH, upper	C5ZZ-6522801-BR
64-66 RH, lower	C5ZZ-6522810-BR
64-66 LH, lower	C5ZZ-6522811-BR
67-68 RH, upper	C7ZZ-6522800-C
67-68 LH, upper	C7ZZ-6522801-C
67-68 RH, lower	C7ZZ-6522810-CR
67-68 LH, lower	C7ZZ-6522811-CR
69-70 RH, lower	C9ZZ-6522810-A
69-70 LH, lower	C9ZZ-6522811-A
69-70 RH, upper	D0ZZ-6522800-A
69-70 LH, upper	D0ZZ-6522801-A
71-73 RH, upper	D10Z-6522800-A
71-73 LH, upper	D10Z-6522801-A
71-73 RH, lower	D10Z-6522810-A
71-73 LH, lower	D10Z-6522811-A

DOOR LATCHES

DOOR LATCH



This door latch assembly is a beautiful copy of a complicated stamping. Comes fully assembled and ready to install.

Door Latch

65-66 RH	C4SZ-6321812-C
65-66 LH	C4SZ-6321813-C
67-68 RH	C60Z-6221812-A
67-68 LH	C60Z-6221813-A
69-70 RH	C9AZ-6221812-A
69-70 LH	C9AZ-6221813-A

DOOR LATCH REINFORCEMENT KIT



Door Latch Reinforcement Kit Does Both Doors, 12 piece kit includes 6 bolts and 6 washers.

Door Latch Reinforcement Kit

64-70	CODB-3447
-------------	-----------

DOOR LATCH RETAINER BUSHING KIT



Door Latch Retainer Bushing. 4 piece kit.

Door Latch Retainer Bushing Kit

64-66	C4SZ-6321801-C
-------------	----------------

DOOR LATCH ROD RETAINER

Door Latch Rod Retainer



64-66: Concours
C3AZ-6221952-BR



65-66: White economy replacement
C3AZ-6221952-A



67-73: Concours
C5AZ-6221952-AR

DOOR LATCH SCREW



Correct screws with special star washers. Set of six.

Door Latch Screw

64-70 Set of 6	356782-5
----------------------	----------

DOOR LATCH SPRING



Correct stainless steel spring for door latch.

Door Latch Spring

67-70	357212-5
-------------	----------

DOOR LOCK KNOB



Made by Plastic injection. Sold as a pair. Available in black, chrome, or satin chrome.

Door Lock Knob

64-66 Chrome	C5DZ-6221850-A
64-66 Satin chrome	C5DZ-6221850-S
67 Chrome	C5AZ-6221850-A
68-73 Chrome	C8AZ-6221850-A

DOOR LOCK KNOB GROMMET



The grommet that goes around the door lock knob, comes in chrome or stainless.

Door Lock Knob Grommet

- 64-70 Clear plasticC5DZ-6221999-B
- 65-73 ChromeC5DZ-6221999-C
- 69-73 stainlessD0DZ-6221999-AR

DOOR LOCK ROD



Zinc plated rods that are bent correctly.

Door Lock Rod

- 65-66 LH, set of 3C5Z-65213452LH
- 65-66 RH, set of 3C5Z-65213452RH
- 67-68 LH, set of 3C7Z-65213452LH
- 67-68 RH, set of 3C7Z-65213452RH

DOOR SHAFT ASSEMBLY



Gold cadmium plated and made from our own tooling. Our 64-66 standard interior shafts will accommodate early clip-on handles.

Door Shaft Assembly

- 64-66 std., RHC5Z-6521818-C
- 64-66 std., LHC5Z-6521819-C
- 65-66 Pony, RHC5Z-6521818-B
- 65-66 Pony, LHC5Z-6521819-B
- 67-68 RHC60Z-6221818-B
- 67-68 LHC60Z-6221819-B

DOOR LIGHTS

DOOR COURTESY LIGHT LENS



Replace those yellowed lenses with our clean white reproduction. Sold in matching pairs.

Door Courtesy Light Lens

- 67-68 dlx.C7Z-13731-B

DOOR COURTESY LIGHT ASSEMBLY

These assemblies feature bright white lenses, beautiful chrome plating, correct wiring and housing. Mounting hardware included. These are the best on the market.

Door Courtesy Light Assembly



- 65-66: dlx.
C5Z-13786



- 67-68: dlx.
C7Z-13A744-C



- 69-70: dlx., set of 2
C9WY-13776/7-A



DOOR PANELS & COMPONENTS

1964-65 DOOR PANEL



Our door panels are upholstered with the original material, mounted on precision

die-cut fiberboard. Colors and textures are identical to the originals. Includes chrome plated plastic trim where appropriate.

Door Panel, 1964-65

- 64-65 BlackC5Z-65239423BK
- 64-65 BlueC5Z-65239423BL
- 64-65 Ivy goldC5Z-65239423IG
- 64-65 PalaminoC5Z-65239423PA
- 64-65 RedC5Z-65239423RD
- 64-65 WhiteC5Z-65239423WT

1965-66 DELUXE DOOR PANEL



These panels are the finest available. Excellent molded vinyl surface with the correct

grain. Foam filled on treated pressboard. These door panels DO NOT include stainless steel trim pieces.

Door Panel, 1965-66 Deluxe

- 65 Bright redC5Z65239423RDP
- 65-66 BlackC5Z65239423BKP
- 65-66 WhiteC5Z65239423WTP
- 66 Dark redC5Z65239423DRP
- 66 ParchmentC5Z65239423PRP

1966 DOOR PANEL



Our door panels are upholstered with the original material, mounted on precision

die-cut fiberboard. Colors and textures are identical to the originals. Includes chrome plated plastic trim where appropriate.

Door Panel, 1966

- 66 BlackC6Z-65239423BK
- 66 AquaC6Z-65239423AQ
- 66 BlueC6Z-65239423BL
- 66 Dark redC6Z-65239423DR
- 66 ParchmentC6Z-65239423PR

1967 DOOR PANEL



Our door panels are upholstered with the original material,

mounted on precision die-cut fiberboard. Colors and textures are identical to the originals. Includes chrome plated plastic trim where appropriate.

Door Panel, 1967

- 67 BlackC7Z-65239423BK
- 67 AquaC7Z-65239423AQ
- 67 BlueC7Z-65239423BL
- 67 Ivy goldC7Z-65239423IG
- 67 ParchmentC7Z-65239423PR
- 67 RedC7Z-65239423RD
- 67 SaddleC7Z-65239423SA

1967 DELUXE DOOR PANEL



These panels are the finest available. Excellent molded vinyl surface with the correct

grain. Foam filled on treated pressboard. These door panels do not include stainless steel trim pieces, or aluminum inserts.

Door Panel, 1967 Deluxe

- 67 BlackC7Z65239423BKD
- 67 BlueC7Z65239423BLD
- 67 Ivy goldC7Z65239423IGD
- 67 ParchmentC7Z65239423PRD
- 67 RedC7Z65239423RDD

1968 DOOR PANEL



Our door panels are upholstered with the original material, mounted on precision

die-cut fiberboard. Colors and textures are identical to the originals. Includes chrome plated plastic trim where appropriate.

Door Panel, 1968

- 68 BlackC8Z-65239423BK
- 68 BlueC8Z-65239423BL
- 68 Ivy goldC8Z-65239423IG
- 68 MaroonC8Z-65239423MR
- 68 Nugget goldC8Z-65239423NG
- 68 ParchmentC8Z-65239423PR
- 68 SaddleC8Z-65239423SA

1968 DELUXE DOOR PANEL

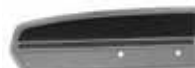

These panels are the finest available. Excellent molded vinyl surface with the correct

grain. Foam filled on treated pressboard. These door panels do not include stainless steel trim pieces, or aluminum inserts.

Door Panel, 1968 Deluxe

- 68 BlackC8Z65239423BKD
- 68 AquaC8Z65239423AQD
- 68 BlueC8Z65239423BLD
- 68 Ivy goldC8Z65239423IGD
- 68 MaroonC8Z65239423MRD
- 68 Nugget goldC8Z65239423NGD
- 68 ParchmentC8Z65239423PRD
- 68 SaddleC8Z65239423SAD

WE PROUDLY FEATURE AUTHENTIC MUSTANG REPRODUCTIONS FROM SCOTT DRAKE ENTERPRISES!



1969 STANDARD DOOR PANEL



Our door panels are upholstered with the original material, mounted on precision

die-cut fiberboard. Colors and textures are identical to the originals. Includes chrome plated plastic trim where appropriate.

Door Panel, 1969 Standard

69	BlackC9ZZ-65239423BK
69	Dark ivy goldC9ZZ-65239423DI
69	Dark redC9ZZ-65239423DR
69	Light blueC9ZZ-65239423LB
69	Nugget goldC9ZZ-65239423NG
69	WhiteC9ZZ-65239423WT

1969-70 DELUXE DOOR PANEL



These panels are the finest available. Excellent molded vinyl surface with the correct

grain. Foam filled on treated pressboard. These door panels do not include stainless steel trim pieces, or aluminum inserts. Some cutting may be required.

Door Panel, 1969-70 Deluxe

69	Black w/ black carpet	..C9ZZ65239423BKD
69	Dark red w/ maroon carpetC9ZZ65239423DRD
69	White w/ black carpet	C9ZZ65239423WTD
70	Medium blue w/ blue carpetC9ZZ65239423BLD
70	Black w/ black carpet	..D0ZZ65239423BKD
70	Ginger w/ dark brown carpetD0ZZ65239423GID
70	White w/ black carpet	D0ZZ65239423WTD

1970 DOOR PANEL



Our door panels are upholstered with the original material, mounted on precision

die-cut fiberboard. Colors and textures are identical to the originals. Includes chrome plated plastic trim where appropriate.

Door Panel, 1970

70	BlackD0ZZ-65239423BK
70	BlueD0ZZ-65239423BL
70	Bright redD0ZZ-65239423BR
70	GingerD0ZZ-65239423GI
70	Ivy goldD0ZZ-65239423IG
70	WhiteD0ZZ-65239423WT

1971-73 DOOR PANEL



Our door panels are upholstered with the original material, mounted on precision

die-cut fiberboard. Colors and textures are identical to the originals. Includes chrome plated plastic trim where appropriate.

Door Panel, 1971-73

71-73	BlackD1ZZ-65239423BK
71-73	BlueD1ZZ-65239423BL
71-73	Bright redD1ZZ-65239423BR
71-73	GingerD1ZZ-65239423GI
71-73	GreenD1ZZ-65239423GR
71-73	Ivy goldD1ZZ-65239423IG
71-73	WhiteD1ZZ-65239423WT

1971-73 DELUXE DOOR PANEL



These panels are the finest available. Excellent molded vinyl surface with the correct

grain. Foam filled on treated pressboard. These door panels do not include stainless steel trim pieces, or aluminum inserts.

Door Panel, 1971-73 Deluxe

71-73	BlackD1ZZ65239423BKD
71-73	Medium blueD1ZZ65239423BLD
71-73	GingerD1ZZ65239423GID
71-73	WhiteD1ZZ65239423WTD

2-TONE DOOR PANEL



Made with tough Masonite® backing instead of cardboard for extra durability and easy installation. Two-

tone panels are available in a variety of color combinations.

Door Panel, 2-Tone

65	Med Blue/whiteC5ZZ65239423B/W
65	Black/whiteC5ZZ65239423BK/W
65	Ivy gold/whiteC5ZZ65239423I/W
65	Palamino/whiteC5ZZ65239423P/W
65	Bright red/whiteC5ZZ65239423R/W
66	Aqua/whiteC6ZZ65239423A/W
66	Dark Blue/whiteC6ZZ65239423B/W
66	Black/whiteC6ZZ65239423BK/W
66	Parchment/whiteC6ZZ65239423P/W
66	Dark red/whiteC6ZZ65239423R/W
67	Aqua/whiteC7ZZ65239423A/W
67	Blue/whiteC7ZZ65239423B/W
67	Black/whiteC7ZZ65239423BK/W
67	Ivy gold/whiteC7ZZ65239423I/W
67	Parchment/whiteC7ZZ65239423P/W
67	Dark red/whiteC7ZZ65239423R/W
67	Saddle/whiteC7ZZ65239423S/W

DOOR PANEL CLIP



High quality door panel clips in bulk or nicely packaged in a set of 30.

Door Panel Clip

64-70	std., set of 30380552-K
64-70	std., bulk380552-S
65-66	dlx., set of 30375553-K
65-66	dlx., bulk375553-S

DELUXE DOOR PANEL KIT



Kit includes pads, cups, brackets and mounting hardware.

Door Panel Kit, Deluxe

65-66	BlackKIT-INT5-BK
65-66	WhiteKIT-INT5-WT

DOOR PANEL CUP



Black plastic cup with correct texture and chrome beauty rings.

Door Panel Cup

69-70	std. int.C9ZZ-65226A34
-------	-----------	--------------------

64-66 PONY DOOR PANEL CUP



Feature perfect fit and color match. Ours are double dipped in textured vinyl just like originals.

Door Panel Cup, 64-66 Pony

64-66	BlackC5ZZ-6524142-BK
64-66	Bright redC5ZZ-6524142-BR
64-66	Dark redC5ZZ-6524142-DR
64-66	ParchmentC5ZZ-6524142-PR
64-66	WhiteC5ZZ-6524142-WT

69-70 DELUXE DOOR PANEL CUP



New pressure die cast zinc construction just like the originals, but stronger.

1969 version

Door Panel Cup, 69-70 Deluxe

69	Black, pairC9ZZ6524046/7BK
69	White, pairC9ZZ6524046/7WT
69	Black, RHC9ZZ-6524046-BK
69	White, RHC9ZZ-6524046-WT
69	Black, LHC9ZZ-6524047-BK
69	White, LHC9ZZ-6524047-WT
70	Black, pairD0ZZ-6524046/7B
70	White, pairD0ZZ-6524046/7W

SHOP WITH CONFIDENCE! WE OFFER SUPERIOR-QUALITY PARTS FOR ALL YOUR MUSTANG RESTORATION NEEDS.

DELUXE DOOR PANEL CUP BRACKET



This support bracket is used to fasten the Pony door cups to the inner door on 1965-67 Deluxe interiors. It takes two of these per car.

Door Panel Cup Bracket, Deluxe
65-67 C5Z-6524140

DOOR PANEL CUP PAD



Textured rubber pad that covers the door cup mounting screws. Correct color match.

Door Panel Cup Pad
65-67 Black C5SZ-6324046-BK
65-66 Bright red C5SZ-6324046-BR
66-67 Dark red C5SZ-6324046-DR
66-67 Parchment C5SZ-6324046-PR
65-66 White C5SZ-6324046-WT

DOOR HANDLE BEZEL



Trim behind door handle.

Door Handle Bezel
69-70 dlx. int. C9Z-6522634-D

DOOR PANEL EMBLEM

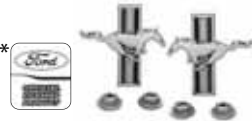

Beautiful detail. Features bright chrome finish and paint. Hardware included.

Door Panel Emblem
69-70 69 All, 70 dlx.: Running horse* C9ZB-6520820/3

DOOR PANEL INSERT WITH ALUMINUM PANEL



We have produced these panels from our own tooling with exact detailing right down to the black painted

border. Included is a pair of high quality, adhesive backed, woodgrain vinyl inserts, available in dark walnut or light teak. Don't forget about our beautiful mustang emblems to finish off these panels.

Door Panel Insert with Aluminum Panel
69-70 Teak inserts C9ZZ-6523942/3T
69-70 Walnut inserts C9ZZ-6523942/3W

DOOR PANEL INSERT

These deluxe door panel inserts are made of high quality brushed aluminum or vinyl woodgrain.

Door Panel Insert
67: Brushed alum. w/ correct polished raised bead & mounting spikes
C7ZZ-65237A22/3



69-70: Walnut
C9Z-65237A22-A



69-70: Teak
C9Z-65237A22-T

DELUXE DOOR PANEL TRIM

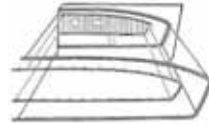

Made by Scott Drake, these Deluxe Door Panel Moldings are constructed of Stainless Steel. They feature all the exact

detail of the original and are designed to fit new-reproduction deluxe panels. Sold in pairs.

Door Panel Trim, Deluxe
65-66 RH C5Z-652042/70
65-66 LH C5Z-652043/71
65-66 LH & RH C5Z-652042/71S
67 LH & RH C7Z-6520970/1

DOOR PANEL U-CUP



This Plastic formed cup is used for the inside door handle pocket, not included with reproduction door panels.

Door Panel U-Cup
67 Black, dlx. int., not concours .C7ZZ-6524148-BK

DELUXE DOOR PULL



Exact reproduction of the originals. Exact detail of stitches and grain pattern.

Door Pull, Deluxe
68 Aqua, pair C8ZZ-6526656-AQ
68 Black, pair C8ZZ-6526656-BK
68 Dark blue, pair C8ZZ-6526656-BL
68 Maroon, pair C8ZZ-6526656-MR
68 Parchment, pair C8ZZ-6526656-PR
68 Saddle, pair C8ZZ-6526656-SA



71-73 Black, LH D1ZZ-6526655-BK
71-73 Blue, LH D1ZZ-6526655-BL
71-73 Ginger, LH D1ZZ-6526655-GI
71-73 Black, RH D1ZZ-6526656-BK
71-73 Blue, RH D1ZZ-6526656-BL
71-73 Ginger, RH D1ZZ-6526656-GI

INNER DOOR PULL BRACE



Exact reproduction. Includes mounting hardware and nylon inserts. Painted black.

Door Pull Brace, Inner
68 dlx. int. C8AZ-6522606-A

DOOR PULL END CAP KIT

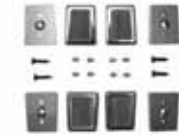

Our door pull end caps feature beautiful chrome and wood grain insert that matches the dash and door panel wood

grain. We feel these look a lot nicer than the original. All mounting hardware included. Inner door braces sold separately.

Door Pull End Cap Kit
68 dlx. int. C7WY-6522670/6

WOODGRAIN DOOR PULL INSERTS



These are the same inserts that are available in our complete door pull end cap kit, but now available on

their own. Quickly and easily replace worn or missing inserts. Sold as a set of 4 inserts.

Door Pull Inserts, Woodgrain
68 Set of 4 C7WY-6522670-A

DOOR SPEAKER GRILLE

A nice reproduction speaker grill. Features correct screen pattern and edge molding. Includes hardware.

Speaker Grille, Door



65-66
C6ZZ-18798-A



67-68: dlx., also fits 65-66 doors for a custom look, use C7ZN-3301 for proper installation
C7ZZ-6520956/7A



69-70: "Stereo" script
C9Z-18798-A



71-73
D2ZZ-18978-A

WE PROUDLY FEATURE AUTHENTIC MUSTANG REPRODUCTIONS FROM SCOTT DRAKE ENTERPRISES!



DOOR WATERSHIELD



Protects door panels and upholstery from water damage. Specially treated

paper, precisely die-cut for an easy installation

Door Watershield	
65-66 FB	C5Z-63-W5
64-66 CP	C5Z-65-W5
64-66 CV	C5Z-76-W5
67-68 FB	C7Z-63-W5
67-68 CP	C7Z-65-W5
67-68 CV	C7Z-76-W5
69-70 FB	C9Z-63-W5
69-70 CP	C9Z-65-W5
69-70 CV	C9Z-76-W5
71-73 FB	D1Z-63-W5
71-73 CP	D1Z-65-W5
71-73 CV	D1Z-76-W5

EXTERIOR DOOR PARTS

DOOR ACCESS PLUG



Steel stamped with nickel plating. Original should be painted body color.

Door Access Plug	
64-66	C5Z-6522286

DOOR AND QUARTER SEAL SCREW



Used to secure the seals both on the quarter panel and on the rear of the door window seal. Black oxide finish.

Door And Quarter Seal Screw	
64-73 Bulk, sold in bags of 100	52718-SMK
65-68 Set of 22	52718-S

DOOR BUMPER



Made from first-class E.P.D.M. rubber. Usually eliminates door rattling by replacing those stone-hard originals. Available in bulk or sets of 4.

Door Bumper	
64-68 Bulk	C2AZ-6223030-A
64-68 Set of 4	C2AZ-6223030-K
69-73 Set of 4	C7AZ-54265A28AA

DOOR EDGE GUARD



Protects paint, made from rust resistant stainless steel.

Door Edge Guard	
64-66	C5Z-6520910/1
67-68	C7Z-6520910/1
69-70	C9Z-6520910/1
71-73	D1Z-6520910/1

DOOR HINGE MOUNT KIT



OE looking bolts with built in washers. Black oxide finish.

Door Hinge Mount Kit	
64-65 6 bolts, black, 3/8" threads	379043-SMK
66-68 6 bolts, black, 5/16" threads	380575-S2

DOOR TAG PLATE



Exact copies of the original data plate tags. Reverse stamped, like

originals, to match your cars specifications. Attaches to driver's door inside jam. Specify VIN, body, color, trim, date of manufacture, DSO, axle and transmission codes. Authentic mounting rivets are also included. Must fax or email your VIN info. Allow 3 weeks to receive.

Door Tag Plate	
64-69 w/ rivets	DT-1

DOOR TAG PLATE RIVETS



Special aluminum attaching rivets. Authentic look.

Door Tag Plate Rivets	
64-69	C5Z-6223000-A

FRONT DOOR TO WINDOW SEAL

Made from a high quality rubber. These feature a steel insert molded inside. Fits on rear door edge.

Door To Window Seal, Front



64-66	C5Z-6520588/9B
-------	----------------



67: Early 67 Cougar	C7Z-6520588/9A
---------------------	----------------



67-68: Late 67 Cougar	C7Z-6520588/9B
-----------------------	----------------



69-70	C9Z-6520264/5A
-------	----------------

STRIKER PLATE SCREW



Gold cadmium plated screws to attach door strikers.

Striker Plate Screw	
64-70 Set of 4	378428-S

STRIKER ASSEMBLY

Original factory type striker. Includes attaching parts.

Striker Assembly



64-66: Gold zinc	C2OZ-6222008-B
------------------	----------------



67-70: Silver zinc, date coded 8-66	C5AZ-6222008-A
-------------------------------------	----------------

68-70: Silver zinc, date coded 11-67	C5AZ-6222008-B
--------------------------------------	----------------



71-80: Silver zinc	D2AZ-6522008-A
--------------------	----------------

TOP VENT WINDOW SEAL



Made from compression molded E.P.D.M. rubber with cadmium plated steel inserts molded inside. Includes rivets. Sold

in sets.	
Top Vent Window Seal	
64-66	C5Z-6521774/5A

VENT SEAL EDGE RIVET



Correct black oxide semi-tubular rivet.

Vent Seal Edge Rivet	
64-66 Set of 10	351603-S

VENT WINDOW BRACKET



Bracket with shaft to tighten up loose handles.

Vent Window Bracket	
64-66 RH	C5Z-6521608-RK
64-66 LH	C5Z-6521609-RK

VENT WINDOW CHANNEL



Vent Window Channel	
67-68 RH	C7Z-6521538-A
67-68 LH	C7Z-6521539-A

VENT WINDOW DIVISION BAR SEAL



Offers a perfect fit with a steel insert molded into high quality E.P.D.M. rubber. Mounts on back side of vent window bar.

Now original type rivets included.

Vent Window Division Bar Seal

64-66 CSZZ-6521450-A

VENT WINDOW FRAME



Die cast construction with good chrome plating.

Vent Window Frame

64-66 LH CSZZ-6522204-L

64-66 RH CSZZ-6522204-R

67-68 LH CZZZ-6522204-L

67-68 RH CZZZ-6522204-R

VENT WINDOW FRAME TO DOOR SEAL



Seals between chrome vent frames and door on exterior side.

Vent Window Frame To Door Seal

67-68 C60Z-6322280

REAR VERTICAL GLASS RUN REPAIR KIT



Original type style mohair/felt which covers run channel. Includes adhesive backing. Repairs both sides, Channel not included.

Rear Vertical Glass Run Repair Kit

64-66 CSZZ-6521508-RK

FRONT DOOR GLASS RUN CHANNEL



Vertical channel which runs behind vent window that door glass slides in. Features original type mohair inside channel,

mounting bracket and stainless steel trim.

Door Glass Run Channel, Front

64-66 USA CSZZ-6521538/9A

64-66 Import, RH CSZZ-6521538-A

64-66 Import, LH CSZZ-6521539-A

FRONT DOOR GLASS RUN INSERTS

Insert to replace worn rubber and felt channel guide for door glass. Features original looking felt. Top molded pieces are bonded securely and has steel inserts for added strength.

Door Glass Run Inserts, Front



67-68

C7Z-6521546/7A

VENT WINDOW HANDLE



Our vent handles are cast from our own tooling with a great chrome finish. Our nylon tips will not

scratch the vent frame. Sold as a matched pair. Fits several Ford models. Roll pins included.

Vent Window Handle

64-66 C30Z-6222916/7A

67 C60Z-6522916/7A

68-71 C80Z-5422916/7B

VENT WINDOW SEAL



Our high quality Scott Drake reproduction vent seals offer your customers the finest molded rubber pieces available.

Vent Window Seal

65-66 RH & LH CSZZ-6521448/9B

67-68 RH CZZZ-6521448-AR

67-68 LH CZZZ-6521449-AR

VENT WINDOW SEAL KIT



Convenient time saving kit offers you everything to complete vent seal installation. Kit features vents seals, top vent seals, back edge vent seals, and all rivets. Check out

our rivet tools to make the job easier.

Vent Window Seal Kit

64-66 KIT-RUB-5

VENT WINDOW TO DOOR SEAL



These high quality vent window seals are the first on the market to replace the original Ford part exactly. This is

the small seal at the front of the door and next to the door weatherstrip.

Vent Window To Door Seal

67-68 CZZZ-6522332/3

WEATHER STRIP ADHESIVE



Super strong weatherstrip adhesive for installing door and trunk seals. From

3M. Supplied in five ounce tubes. Cannot be shipped by air.

Weather Strip Adhesive

64-73 Yellow, not for EPDM rubber ... 3M-8001

64-73 Black, not for EPDM rubber 3M-8008

64-73 Black, for EPDM rubber 3M-8011

DOOR WEATHER STRIPPING

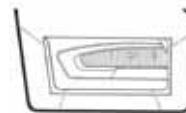

Made from the finest E.P.D.M. rubber, these sponge extrusions have transfer molded ends like the originals. These

are not glued and feature the correct cross section and size for proper sealing. Includes original looking mounting fasteners.

Weather Stripping, Door

64-66 Door CSZZ-6520530/1A

67-68 Door CZZZ-6520530/1A

69-70 Door C9ZZ-6520530/1A

71-73 Door D1ZZ-6520530/1A

DOOR BOTTOM WEATHER STRIPPING



This seal cuts down wind and road noise. attaching hardware included.

Weather Stripping, Door Bottom

69-70 Door Bottom C9ZZ-6520272-A

WINDOW & ROOFRAIL SEAL CLIP



Stamped steel with molded black vinyl, mounts on roofrail. Helps to hold weatherstrip and guides window glass. 4 required per car.

Window & Roofrail Seal Clip

69 CP & FB C9ZZ-6522204

WINDOW SEALER



Used to water-proof windshield and rear window. Silicone type sealer is best suited for glue in windshields.

Window Sealer

64-73 Non-hardening CRL-7708

69-73 Silicone based 3M-8606

Door Parts

WE PROUDLY FEATURE AUTHENTIC MUSTANG REPRODUCTIONS FROM SCOTT DRAKE ENTERPRISES!



WINDOW CHANNEL STRIP



We proudly carry the full line of Re-Pops window channel strips. Rest assured that these are the highest quality on the market. These window

channel strips have the correct bends and staples. They also come with easy to understand instructions and a drill bit for installation.

Window Channel Strip

65-66 FB	C5ZZ-6321458/9S
65-66 CP & CV	C5ZZ-6521458/9S
67-68 FB	C7ZZ-6321458/9S
67-68 CP	C7ZZ-6521458/9S
67-68 CV	C7ZZ-7621458/9S
69-70 FB	C9ZZ-6321458/9S
69-70 CP	C9ZZ-6521458/9S
69-70 CV	C9ZZ-7621458/9S
71-73 FB	D1ZZ-6321458/9S
71-73 CP	D1ZZ-6521458/9S
71-73 CV	D1ZZ-7621458/9S

ECONOMY WINDOW CHANNEL STRIP



These feature narrow outer strips rather than concours wide outer strips. Good alternative for daily drivers.

Window Channel Strip, Economy

64-66 CP & CV, economy	C5ZZ-6521458/9E
65-66 FB, economy	C5ZZ-6321458/9E

WINDOW REGULATORS AND COMPONENTS

DOOR GLASS ASSEMBLY



This door glass includes the frame, glass run and mounting bracket. Available in clear glass only. For replacement

glass only, see the "Windows" section towards the end of this catalog.

Door Glass Assembly

67-68 FB, LH	C7ZZ-6321410-KL
67-68 FB, RH	C7ZZ-6321410-KR
67-68 CP, LH	C7ZZ-6521410-KL
67-68 CP, RH	C7ZZ-6521410-KR
67-68 CV, LH	C7ZZ-7621410-KL
67-68 CV, RH	C7ZZ-7621410-KR

DOOR GLASS BUMPER



Rubber bumper that installs inside the bottom of the door that stops the travel of door glass. One required per door, snaps into place.

Door Glass Bumper

64-70 Lower	C5ZZ-6521762
-------------	-------	--------------

WINDOW GROMMET



Protects door glass when attaching window channel.

Window Grommet

69-70	C9ZZ-6523258-B
-------	-------	----------------

WINDOW GUIDE BUSHING



Injected molded plastic and wear resistant.

Window Guide Bushing

69-70	C9ZZ-6323266
-------	-------	--------------

DOOR WINDOW REGULATOR



Window Regulator, Door

64	Concours, RH	C5ZZ-6523202-A
64	Concours, LH	C5ZZ-6523203-A
65-66	Concours, RH	C5ZZ-6523202-B
65-66	Concours, LH	C5ZZ-6523203-B
67	Concours, RH	C7ZZ-6523200-AR
67	Concours, LH	C7ZZ-6523201-AR
68	Concours, RH	C8ZZ-6523200-AR
68	Concours, LH	C8ZZ-6523201-AR
69	RH	C9ZZ-6523200-AR
69	LH	C9ZZ-6523201-AR
70	RH	D0ZZ-6523200-AR
70	LH	D0ZZ-6523201-AR

UNIVERSAL DOOR WINDOW REGULATOR



Good quality universal style fits both screw on and clip on style window cranks. Same high quality as our concourse regulators

but with a specially designed shaft that will fit both styles of cranks. 1 year warranty.

Window Regulator, Universal Door

64-66	Universal, RH	C5ZZ-6523202-E
64-66	Universal, LH	C5ZZ-6523203-E

QUARTER WINDOW REGULATOR



Cadmium plated to prevent rust. Engineered for a perfect fit. Will not self destruct like others.

Window Regulator, Quarter

64-67	LH	C5ZZ-6530306-L
64-67	RH	C5ZZ-6530306-R
69-70	LH	C9ZZ-6530306-L
69-70	RH	C9ZZ-6530306-R
71-73	LH	D1ZZ-6530306-L
71-73	RH	D1ZZ-6530306-R

WINDOW REGULATOR RETAINER CLIP



Secures window regulator to scissor mechanism.

Window Regulator Retainer Clip

64-66	353745-S
-------	-------	----------

WINDOW REGULATOR SCISSOR ASSEMBLY



Very nice copy of scissor assembly that allows door glass to move up and down.

Window Regulator Scissor Assembly

64-66	LH	C5ZZ-6523234-L
64-66	RH	C5ZZ-6523234-R

WINDOW ROLLER & CLIP



Used on door and quarter window regulators scissors. Replacement makes window glass move easier.

Window Roller & Clip

64-68	COAB-6423240-B
-------	-------	----------------

ELECTRICAL & LIGHTING

ELECTRICAL REFERENCE BOOKS

WIRING DIAGRAM MANUAL



Covers a multitude of electrical pictorial diagrams, color codes are listed, plus easy to follow schematics.

Wiring Diagram Manual

64	MP-312
65	MP-1
66	MP-2
67	MP-3
68	MP-4
69	MP-5
70	MP-6
71	MP-7
72	MP-8
73	MP-9

LARGE FORMAT WIRING DIAGRAM MANUAL



Covers a multitude of electrical pictorial diagrams, color codes are listed, plus easy to follow schematics. Our large format features

larger diagrams that are easier to read.

Wiring Diagram Manual, Large Format

64	MP-311-P
65	MP-1-P
66	MP-2-P
67	MP-3-P
68	MP-4-P
69	MP-5-P
70	MP-6-P
71	MP-7-P
72	MP-8-P
73	MP-9-P

FOG LIGHTS

G.E. FOG LIGHT BULB



Features original GE logo and "fog" script on lens

Fog Light Bulb, G.E.

65-68	Clear	FDU-15220-A
65-68	Amber	FDU-15220-AMBER

FOG LIGHT HOUSING ASSEMBLY



These Fog Light Housing Assemblies are the best on the market. Assemblies include triple chrome-plated rims, silver

painted housings on back, an exact copy of the wiring harness, cup mounting washer, and serrated flange nut. They also feature the correct wire exit and drain hole. Bulb not included.

Fog Light Housing Assembly

65-67	C5ZZ-15200-A
68	C8ZZ-15200-A
68	Blue plug, concours correctC8ZZ-15200-AC

TRI-BAR FOG LIGHT HOUSING ASSEMBLY



These 4" fog lamps feature our quality fog light housings, beautiful chrome bezels, and include an internal chrome, tri-bar

design. The perfect match to our larger, tri-bar headlights.

Fog Light Housing Assembly, Tri-Bar

64-67	C5ZZ-15200-TB
-------	-------	---------------

FOG LIGHT HOUSING RIM



For customers who wish to restore their own housings, these perfect reproductions feature triple chrome plating and an exact

fit.

Fog Light Housing Rim

65-68	w/ bar	C5ZZ-15214-A
65-68	w/out bar	C5ZZ-15214-SPEC

FOG LIGHT SWITCH

Nice reproduction of original part, which duplicates the factory wiring pigtail, bezel & knob

Fog Light Switch



65: Factory plug for orig. 65 GT cars only
C5ZZ-15A214-A

65-66: Complete w/ pigtail
C6ZZ-15A214-A

67
C7ZZ-15A214-A

68
C8ZZ-15A214-A

FOG LIGHT WIRING CIRCUIT BREAKER



Mounts under dash, controls voltage for wire protection. Includes primary wire

which connects to Headlamp Switch Plug.

Instructions included.

Fog Light Wiring Circuit Breaker

65-68	C5ZZ-15223-CB
68	C8ZZ-14448-F

FOG LIGHT WIRING CONVERSION KIT



Everything you need to hook up your fog lights. Kits feature correct colored connectors and include circuit breaker.

(Fog light switch sold separately).

Fog Light Wiring Conversion Kit

64-65	Instrument warning light cars	C5ZZ-15223-FUD
66-67	All non GT cars	C6ZZ-15223-FUD
68	C8ZZ-15223-FUD

FOG LIGHT WIRING FEED



Hot wire from fog light under-dash harness to fog light housing pigtail. Connects left

and right fog light. 1965 GT cars originally had this feed wrapped into the headlight harness.

Fog Light Wiring Feed

64-65	Warning light cars	C5ZZ-15223-FF
66-67	GT & non GT cars	C6ZZ-15223-FF
68	w/ correct blue plugs	C8ZZ-15223-UHH

FOG LIGHT WIRING GROUND



All black wire which plugs into fog lamp pigtail and grounds to radiator support.

Fog Light Wiring Ground

65-68	C5ZZ-15223-GR
-------	-------	---------------

FOG LIGHT WIRING PIGTAIL



Pigtail wires which connect to bulb and run through housings and plug into fog light feed. Not necessary if purchasing fog

lamp housings as pigtails are included.

Fog Light Wiring Pigtail

64-67	Correct connectors	C5ZZ-15223-FGPT
68	Correct blue plug	C8ZZ-15223-FGPT

WE PROUDLY FEATURE AUTHENTIC MUSTANG REPRODUCTIONS FROM SCOTT DRAKE ENTERPRISES!



FOG LIGHT WIRING UNDER-DASH HARNESS



Correct color coded wiring for fog lights.

Fog Light Wiring Under-Dash Harness	
65 CSZZ-15223-UDH
66 C6ZZ-15223-UDH
67 C7ZZ-15223-UDH
68 C8ZZ-15223-UDH
69	Shelby S9MS-15223-A

HEADLIGHTS

HEADLIGHT



We stock reproduction headlights, acid-etched with the FoMoCo logo

just as the originals were, as well as high performance replacements. See our website for individual pictures.

Headlight	
64-73	Low beam 4000
64-73	High beam 4001
64-73	std. 6014
64-73	FoMoCo script* CSZZ-13007-A
64-73	hi-po, Tri bar CSZZ-13007-CLR
64-73	hi-po, Tri bar, blue CSZZ-13007-LBB
64-73	hi-po, Euro CSZZ-13007-H
64-73	hi-po, Xenon CSZZ-13007-X
64-73	hi-po, Xenon w/ city lights CSZZ-13007-XCL
69	FoMoCo, high beam* C9ZZ-13007-I
69	FoMoCo, low beam* C9ZZ-13007-O
69	hi-po, Tri bar, clear C9ZZ-13007-CLR
69	Xenon, high beam C9ZZ-13007-XH
69	Xenon, high & low beam C9ZZ-13007-XHL

HEADLIGHT BUCKET



Headlight bucket, painted black, no hardware.

Headlight Bucket	
64-66	RH or LH CSZZ-13008-A
67-68	RH C7ZZ-13008-A
67-68	LH C7ZZ-13008-B
69	RH, Inner C8AZ-13118-A
69	LH, Inner C8AZ-13119-A
70	RH D0ZZ-13118-A
70	LH D0ZZ-13119-A

HEADLIGHT ASSEMBLY HARDWARE KIT



A complete kit to mount a headlight assembly to the fender, everything you need. Sold each, it takes two per car.

Headlight Assembly Hardware Kit	
64-66 CSZZ-13008-MK
67-68 C7ZZ-13008-MK

HEADLIGHT BUCKET ASSEMBLY



Reproduction headlight bucket assembly. Kit contains mounting hardware.

Headlight Bucket Assembly	
65-66	RH CSZZ-13008-CR
65-66	LH CSZZ-13008-DR
67-68	RH C7ZZ-13008-CR
67-68	LH C7ZZ-13008-DR
69	RH C9ZZ-16018-R
69	LH C9ZZ-16019-L
70	RH D0ZZ-16018-R
70	LH D0ZZ-16019-L

HEADLIGHT DIMMER SWITCH



This quality after-market dimmer switch matches the original nicely. Imported. Note: Electrical parts are not returnable

Headlight Dimmer Switch	
64-78	Imported C0TZ-13A024-A

HEADLIGHT DOOR

Die cast headlight door which fits on the headlight assembly. Primered.

Headlight Door	
65-66:	LH CSZZ-13064-A
65-66:	RH CSZZ-13064-B



67-68
C7ZZ-13064-A



67-68: Chrome
C7ZZ-13064-C



69: Outer
C9ZZ-13064-A



69: Inner
C9ZZ-13064-B/C



70
D0ZZ-13064-A/B

HEADLIGHT RETAINING RING



Headlight ring features, high-quality, stamped steel construction.

Headlight Retaining Ring	
64-73	stainless, does not fit 69 D3TZ-13015-A
69	Inner & outer C7AZ-13015-B

HEADLIGHT SWITCH



Quality from Scott Drake, most come from the OE supplier to Ford.

Headlight Switch	
64	W/gen, Repro. CSZZ-11654-C
65-68	OE Supplier CSZZ-11654-B-OE
65-68	Imported CSZZ-11654-BR
69	OE supplier C9ZZ-11654-A
70	OE supplier D0ZZ-11654-A
71-72	After market D3ZZ-11654-A

HEADLIGHT SWITCH BEZEL

New, chrome bezels really make a freshly painted dash pop. Beautiful reproductions.

Headlight Switch Bezel	
64-66	C4DZ-10852-B
67-68	C7ZZ-10852-A
69-70	C9ZZ-10852-L

HEADLIGHT SWITCH COVER



Molded rubber cover which fits over headlight dimmer switch.

Headlight Switch Cover	
65-73 CSZZ-13533

HEADLIGHT SWITCH KNOB



Knob is die-cast zinc, chrome plated with very good detail. Switch shaft is zinc plated to prevent rust or corrosion.

Headlight Switch Knob	
64 C4ZZ-11661-A
65-66 CSZZ-11661-B
67-68 C7ZZ-11661-A
69-70 C9ZZ-11661

HEADLIGHT SWITCH RETAINING NUT



Beautiful chrome retaining nut that holds headlight switch into the dash. These were previously difficult to find. Made from original factory prints.

- Headlight Switch Retaining Nut**
 65-66C5Z-11650-A
 67-68C7Z-11650-A

HEADLIGHT WIRING HARNESS



Connects to firewall near master cylinder and runs along driver side inner fender apron and across radiator support.

Connects headlights, (1967 - 70 do not include headlamp extension).

- Headlight Wiring Harness**
 64C4Z-14290-ALL
 65 w/ gauges & fog lampsC5Z-14290-WG
 65 w/ warning lampsC5Z-14290-WL
 66 w/ gaugesC6Z-14290-ALL
 67 w/out tach, w/out GTC7Z-14290-A
 67 w/out tach, w/ GTC7Z-14290-B
 67 w/ tach, w/out GTC7Z-14290-C
 67 w/ tach, w/ GTC7Z-14290-D
 68 w/out tach, w/out GTC8Z-14290-A
 68 w/ tach, w/out GTC8Z-14290-B
 68 w/ tach, w/out GTC8Z-14290-C
 68 w/ tach, w/ GTC8Z-14290-D
 69 w/out tachC9Z-14290-A
 69 w/ tachC9Z-14290-B
 70 w/out sport lightsD0Z-14290-A
 70 w/ sport lightsD0Z-14290-B
 70 Mach 1, w/ sports lights after 10-15-69D0Z-14290-L

CITY LIGHT HEADLIGHT WIRING HARNESS



This harness kit is required with the Xenon headlamps with "City Lights" option

- Headlight Wiring Harness, City Light**
 64-73 Xenon headlampsC5Z-13007-CLH

HEADLIGHT WIRING HARNESS EXTENSION



Concours correct. Attaches to headlight harness and connects to seal beam.

- Headlight Wiring Harness Extension**
 67-68C7Z-13076-EXT
 69C9Z-13076-EXT
 70D0Z-13076-EXT

HEADLIGHT WIRING RELAY HARNESS



Tired of flickering headlamps, especially when you are running Halogen or other

high-performance headlamps? This Headlamp Relay Harness will eliminate that problem forever! Our easy-to-install relay will improve the performance of your headlamps, giving you better night vision.

Includes installation instructions for classic Mustangs, but this relay can also be used in all Ford products from the same era.

- Headlight Wiring Relay Harness**
 64-73C5Z-14290-RH

ROAD AND RALLY LIGHT KIT



These rugged high power Rally/Road Race lights are similar to the ones used on Mustangs, Shelby's, Falcons & Comets in the 1960's when International

road racing was so popular. These feature 20 gauge uni-body construction and triple chrome plating, No exposed wires, 100 watt replaceable Halogen bulb and easy pivotal adjustability. Kit also includes protective grilles. Perfect for Vintage Broncos too. Not legal for street use in most States.

- Road And Rally Light Kit**
 64-73S1MS-13007-A

HEADLIGHT "ON" WARNING BUZZER



The Scott Drake headlight "ON" warning buzzer is designed to activate when either the parking lights or head

lights are left on after the ignition is turned off. This is a easy to install kit using quick splice connectors. No permanent alterations to the car's wiring are required. Includes instructions for 1965-67 Mustang's, however our warning buzzer kit can also be adapted to fit other makes and models of cars.

- Warning Buzzer, Headlight "On"**
 65-70C6AZ-14931-AR

HOOD TURN SIGNALS

HOOD TURN SIGNAL HARNESS



Connects both L.H. and R.H. turn signal lamps, plugs into firewall harness. Includes sockets.

- Hood Turn Signal Harness**
 67-68C7Z-13A357-TSH
 69-70C9Z-13A357-TSH

HOOD TURN SIGNAL LIGHT ASSEMBLY



A nice reproduction. Includes lens seal.

- Hood Turn Signal Light Assembly**
 67-68C7Z-13A355-B
 69-70C9Z-13A355-A

SEQUENTIAL HOOD TURN SIGNAL LIGHT ASSEMBLY



The latest sequential light kit from Scott Drake. Exclusively designed for the turn signals in the back of the hood scoop. White

led lamps produce highly visible light, even in daylight. Features "plug in and go" simplicity. Works with or without our sequential tail light kit.

- Hood Turn Signal Light Assembly, Sequential**
 67-68C7Z-SHL
 69-70C9Z-SHL

INTERIOR ELECTRICAL

CLOCK FEED WIRE



Correct feed wire for the clock.

- Clock Feed Wire**
 69-70C9Z-15A006-CL

CONSOLE HARNESS FEED



This harness supplies power to the console. Comes from under dash harness and runs underneath carpet, exits at carpet shifter

- hole location.
Console Harness Feed
 64-66 Dash to consoleC5Z-13B712-A
 68 Shelby, dash to consoleS8MS-13B712-A
 69 Dash to consoleC9Z-13B712-A

CONSOLE INTERIOR HARNESS



This harness plugs into console harness feed. Operates rear courtesy lights and front storage compartment on non AC cars.

- Console Interior Harness**
 64-66 w/out ACC5Z-13B711-LG
 64-66 w/ ACC5Z-13B711-SM

Electrical

WE PROUDLY FEATURE AUTHENTIC MUSTANG REPRODUCTIONS FROM SCOTT DRAKE ENTERPRISES!



CONSOLE INTERNAL HARNESS



This harness supplies power to the console. Comes from under dash harness and runs underneath carpet, exits at carpet shifter

hole location.

Console Internal Harness

64-66 Dash to consoleC5ZZ-13B712-A

CONSOLE LAMP LENS



Fits on the rear of the console. Original white plastic color.

Console Lamp Lens

64-66C5ZZ-13734-A

67-68C7ZZ-13783-A

CONSOLE REAR LAMP ASSEMBLY



Good quality reproduction part, features white plastic lens and pressure die cast body with excellent chrome on

the bezel.

Console Rear Lamp Assembly

65-66C5ZZ-13707-A

67-68C7ZZ-13707-A

CONVERTIBLE TOP HARNESS



This is the main harness for the power convertible top. Made in the USA.

Convertible Top Harness

64-68 Concours for 64-66C5ZZ-7615A668

67-68 Concours for 67-68C7ZZ-7615A668

COURTESY LIGHT HARNESS



For deluxe interior cars with door lights and/or door speakers.

Courtesy Light Harness

64-66 w/out speakersC5ZZ-13A769-A

66 w/ speakersC6ZZ-13A769-A

67-68 w/ speakersC7ZZ-13A769-A

69-70 w/ speakersC9ZZ-13A769-A

DOME LIGHT ASSEMBLY



We made a bright chrome base with a brighter than original bulb to really improve lighting inside the car.

We include instructions on how to easily add this dome lamp to earlier Mustangs that didn't have this feature. Our dome light assembly can even be mounted up under the back deck to make a great trunk light. Our reproduction dome lens and chrome bezel as well as the mounting hardware and electrical connectors are included to make this a quick and simple project.

Dome Light Assembly

65-70COAF-13A719-B

DOME LIGHT HOUSING

Housing is chromed plastic.

Dome Light Housing



67-70

COAF-13788-A



71-73

D6UZ-13788-A

DOME LIGHT LENS



High quality injection molded parts, exactly like the originals. Lens is milk white.

Dome Light Lens

67-70COAF-13783-C

71-73D1AZ-13783-B

DOOR SPEAKER CROSSOVER HARNESS



Connects door harnesses to radio.

Door Speaker Crossover Harness

66-70C6ZZ-13A770-A

FUSE BOX REPAIR KIT



New clips to replace loose or corroded fuse holders. Contains eight clips.

Fuse Box Repair Kit

64-68 FUSE CLIPS

INSTRUMENT CLUSTER LOOM



Feature correct color codes.

Instrument Cluster Loom

67 w/ tachC7ZZ-10B942TACH

67 No tachC7ZZ-14401-ICF

68 w/ tachC8ZZ-10B942TACH

68 No tachC8ZZ-14401-ICF

PRINTED INSTRUMENT PANEL CIRCUIT



Great product, this is a complete printed circuit to eliminate those dash electrical problems.

Instrument Panel Circuit, Printed

69-70 w/out tachC9ZZ-10K843-A

INSTRUMENT VOLTAGE REGULATOR



Excellent replacement part, designed to keep the gauges accurate.

Instrument Voltage Regulator

64-65B9MZ-10804-C

66-68C6DZ-10804-A

69-73C9AZ-10804-A

NEUTRAL SAFETY SWITCH HARNESS



Neutral Safety Switch Harness

64-65C5ZZ-7A240-NS

66C6ZZ-7A240-NS

OVERHEAD CONSOLE ASSEMBLY



A beautiful reproduction of a rare option. The console base is made of vinyl and urethane with exact details. We have installed our maplight switch and light housing with our beautiful chrome bezels. Includes wiring harness and mounting screws. Mounting brackets available separately, please refer to the "Interior" section..

Overhead Console Assembly

67	FB, black	C7ZZ-63519A58BK
67	FB, blue	C7ZZ-63519A58BL
67	FB, ivy gold	C7ZZ-63519A58IG
67	FB, parchment	C7ZZ-63519A58PR
67	FB, red	C7ZZ-63519A58RD
67	CP, black	C7ZZ-65519A58BK
67	CP, blue	C7ZZ-65519A58BL
67	CP, ivy gold	C7ZZ-65519A58IG
67	CP, parchment	C7ZZ-65519A58PR
67	CP, red	C7ZZ-65519A58RD

OVERHEAD MAP LIGHT SWITCH

Scott Drake has assembled a set of modern switches into his reproduction map light housing to make a easy replacement of old switches. Works as good as it looks.

Overhead Map Light Switch

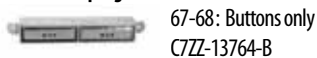

67-68: Buttons only
C7ZZ-13764-B



67-68: Switches only
C7ZZ-13764-S



67-68: Switch & buttons
C7ZZ-13764-KIT

QUARTER PANEL LIGHT



These interior quarter lights are exact copies of the originals. Features include our high quality chrome finish, correct

connector and the flat index to orient the light in the correct position.

Quarter Panel Light

65-68	FB	C4SZ-13776-B
69-70	FB	DOAZ-13776-A

FASTBACK QUATER PANEL LIGHT LENS



Injection molded white plastic.

Quarter Panel Light Lens, Fastback

65-69	C1SZ-13783-B
-------	-------	--------------

RED ACCENT LIGHT



Our CCFL light shines red light that will not distract the driver at night but will bring embroidered floor

mats to life. We encase our light in a tough clear plastic housing that can be mounted just about anywhere inside the car. Designed to be used under the dash or under seats, this light can also be mounted in the trunk or temporarily under the hood to show off these areas.

Red Accent Light

64-68	Red accent light	CSZZ-13760-RED
-------	------------------------	----------------

SHIFT INDICATOR LIGHT



A nice reproduction. Features a bright zinc finish for long life. Ford type connectors for quick installation.

Shift Indicator Light

65-66	All	CSZZ-15A808-A
67-68	w/out console	C7ZZ-15A808-A
67-68	w/ console	C7ZZ-15A808-B

UNDER-DASH HARNESS



Includes fuse block, all molded ends and correct color codes. Note: 1965-66 harnesses do not include Wiper Motor

Loom. Refer to Wiper Motor Looms at the end of this section.

Under-Dash Harness

64	One speed wiper motor	C4ZZ-14401-1SW
64	Two speed wipers	C4ZZ-14401-2SW
65	CSZZ-14401-WL-2
65	GT or pony int.	CSZZ-14401-WG
65	Three speed heater	CSZZ-14401-WL-3
66	C6ZZ-14401-ALL
67	std.	C7ZZ-14401-STD
67	w/ tach	C7ZZ-14401-STDT
67	GT	C7ZZ-14401-GT
67	GT w/ tach	C7ZZ-14401-GT-T
68	std.	C8ZZ-14401-STD
68	w/ tach	C8ZZ-14401-STDT
68	w/ foglamp	C8ZZ-14401-STDF
68	GT w/ tach	C8ZZ-14401-GT-T

AIR CONDITIONER UNDER-DASH HARNESS



Plugs into main A/C unit under dash, connects into back of ignition switch then, runs through firewall to

compressor switch.

Under-Dash Harness, Air Conditioner

64-66	CSZZ-19800-ACF
67	C7ZZ-19800-ACF

SEAT BELT UNDER-DASH REMINDER LIGHT

These lights look exactly like the originals, but feature a state-of-the-art LED light that will not melt the lens like the originals did. The LED light is rated at 100,000 hours & will last for years. This kit comes complete with a timer switch that will turn the light off after a short period of time.

Under-Dash Reminder Light, Seat Belt



65-66: Stick on
C6OZ-10C876-A

67-68: w/ bracket
C7ZZ-10C876-B

PARKING BRAKE UNDER-DASH WARNING LIGHT

These lights look exactly like the originals, but feature a state-of-the-art LED light that will not melt the lens like the originals did. The LED light is rated at 100,000 hours & will last for years. This kit comes complete with a switch and bracket assembly to install on the parking brake unit.

Under-Dash Warning Light, Parking Brake



64-66: Stick on
C4DZ-15A852-A

67-68: w/ bracket
C7ZZ-15A852-A

WIPER MOTOR LOOM



Connects to the wiper switch in dash and runs to the under-dash main harness.

Wiper Motor Loom

65	Two speed	CSZZ-17B587-WL2
65-66	One speed	CSZZ-17B587-WL1
66	Two speed	C6ZZ-17B587-WL2

WE PROUDLY FEATURE AUTHENTIC MUSTANG REPRODUCTIONS FROM SCOTT DRAKE ENTERPRISES!



INTERIOR ELECTRICAL SWITCHES

COURTESY LIGHT SWITCH



Available in two finishes! A white finish that is an exact reproduction of the original Ford part, or a new chrome finish.

All our 68-70 switches feature the "Autolite" logo. Note: Our 68-70 versions are the 2 pin type. Many 1970-73 cars used 3 pin type switches for optional door ajar feature.

Courtesy Light Switch

64-67	White, bulk	C3AZ-13713-A
64-67	White	C3AZ-13713-AK
64-67	Chrome	C3AZ-13713-ACK
68-70	White w/ Autolite logo, bulk	C8AZ-13713-C
68-70	White w/ Autolite logo	..	C8AZ-13713-CK
68-70	Chrome w/ Autolite logo	C8AZ-13713-CKK

COURTESY LIGHT SWITCH SOCKET



This plastic socket is very brittle & almost always breaks when installing a new door jamb switch. Does not

fit cars with door ajar option. Simply install by carefully breaking the old brittle plastic socket apart with pliers, remove, and plug wire leads into the new socket.

Courtesy Light Switch Socket

68-73	C8AZ-14489-K
-------	-------	--------------

TURN SIGNAL FLASHER

High quality replacement parts, may not appear original. Also used for emergency flashers.

Flasher, Turn Signal



65-70: orig. style
C5AZ-13350-B



65-70: Electronic Variable Flasher, for use w/ our sequential tail lights
STL-EVF-13350

HORN SWITCH



Fits deluxe or standard 2 spoke wheel.

Horn Switch

70-73	D2AZ-13875
-------	-------	------------

RIM BLOW HORN SWITCH



The switch that goes inside the rim of the steering wheel to actuate the horn.

Horn Switch, Rim Blow

69	C9AZ-13A875-C
70-73	D1AZ-13A875-A

IGNITION SWITCH



Made for us by the vendor that owns the original tooling, for a truly accurate piece. Switches do not include bezels.

Ignition Switch

64-66	C3UZ-11572-A
67	C5AZ-11572-B
68-69	C8AZ-11572-A

IGNITION SWITCH PIGTAIL



Correct As Original. Repair harness that requires splicing.

Ignition Switch Pigtail

64-66	C3UZ-11572-RPT
-------	-------	----------------

IGNITION SWITCH RETAINER

A "must have" part when installing an ignition switch. Zinc plated for years of service.

Ignition Switch Retainer



64-66
C4DZ-10A885-A



67-68
C7ZZ-11A590-B

NEUTRAL SAFETY SWITCH



High quality replacement switches from the original supplier to Ford.

Neutral Safety Switch

64-67	C-4, before 12-15-66	C4AZ-7A247-C
67-69	C-4, C-6, after 12-15-66	..	C9ZZ-7A247-B
70-73	C-4	D0ZZ-7A247-A
72-73	C-6	D2ZZ-7A247-A

TURN SIGNAL CANCEL CAM

Great reproduction of an often broken part. Turn Signal Cancel Cam



65-66
C3DZ-13318-B



67-71: w/out tilt
C7SZ-13318-BA



68-69: w/ tilt
C8AZ-13318-A



73
D0AZ-13318-A

TURN SIGNAL SWITCH



These switches are made by the OE supplier to Ford. Not a cheap reproduction. 67-69 tilt switches are currently not available. USA made.

Turn Signal Switch

64	Requires splicing	C3OZ-13341-B
65-66	All	C5OZ-13341-B
67	w/out tilt	C7ZZ-13341-F
68	w/out tilt	C8SZ-13341-A
69	w/out tilt	C9AZ-13341-B
70-72	w/out tilt	D2AZ-13341-C
70-72	w/ tilt, requires splicing	..	D2AZ-13341-D
73	w/out tilt	D3AZ-13341-C
73	w/ tilt	D6AZ-13341-A
73	w/out tilt	D6AZ-13341-B

LIGHT BULBS

LIGHT BULBS

Replacement bulbs from O.E.M. suppliers to the auto industry. Excellent quality bulbs



INTERIOR LIGHTS		BULB #
Dome Light	1967 - 70	1003
	Early 1971	105
	Late 1971 - 73	561
Door courtesy light	1965 - 68	1004
Fastback quarter panel	1964 - 70	1003
Floor shift indicator	1964	1445
	1965 - 73	1893
Console ash tray	1970	1892
Console glove box	1964	1445
	1965 - 70	1895

DASHBOARD LIGHTS		BULB #
Under-dash courtesy	1965 - 73	631
Glove box light	1965 - 73	1895
Cigar lighter	1967 - 73	1895
Ash tray	1970	1445
Radio dial light	1964 - 70	1893
Clock light	1967 - 73	1895
Heater control light	1969 - 70	1895
Ignition switch light	1969	1895
Seat belt warning light	1966	1895
	1967 - 73	1445

INSTRUMENT CLUSTER		BULB #
Instrument panel light	1964 - 68	1895
	1969 - 73	194
Turn signal indicator	1964 - 71	1895
	1972 - 73	194
Warning - Oil/Alt/Brakes	1964 - 71	1895
	1972 - 73	194
Bright indicator	1964 - 71	1895
	1972 - 73	194
Rally-Pac clock	1965 - 67	1816
Rally-Pac tach	1965 - 67	1895

EXTERIOR LIGHTS		BULB #
Parking light	1964 - 66	1157
	1967 - 73	1157A
Backup light	1964 - 69	1142
	1970 - 73	1156
Stop/turn signal	1965 - 73	1157
Hood mounted turn indicator	1967 - 68	53
	1969	1895
Rear side marker	1969 - 72	194
	1970	161
License plate light	1964 - 73	97
Headlight (except 1969)	1964 - 73	6014
Headlight (inner bulb high beam)	1969	4001
Headlight (outer bulb low beam)	1969	4000

PARKING LIGHTS

PARK LIGHT ASSEMBLY

* Complete housing with wiring. Bulb and lens included unless stated otherwise.

Park Light Assembly



64-66: RH, bulb & lens not included
C5Z-13206-B

64-66: LH, bulb & lens not included
C5Z-13207-B



67-68: Orange bulb*
C8Z-13200-B



69: RH
C9Z-13200-A

69: LH
C9Z-13201-A

70: RH
D0Z-13200-A

70: LH
D0Z-13201-A



71-72: RH
D1Z-13200-A

71-72: LH
D1Z-13201-A



71-72: Mach 1, RH or LH,
bulb not included
D1Z-13200-B

PARK LIGHT BEZEL

Very nice reproductions. Ready for paint. Sold in pairs.

Park Light Bezel



67-68: Unpainted
C7Z-13210/12



70: Unpainted
D0Z-13210

LED PARK LIGHT INSERT

Brighter more reliable parking lights.



Park Light Insert, LED

64-66 LED C5Z-13200-LED

COMPLETE PARK LIGHT KIT

Kit includes one pair of parking lamp housings, pads, lenses, gaskets, bulbs and mounting hardware.



Park Light Kit, Complete

64-66 KIT-ELC-1

PARK LIGHT LENS

* Made to original specifications.



Park Light Lens

64: White, w/ FoMoCo logo*
C5Z-13208-WTR

65-66: Amber, w/ FoMoCo logo*
C5Z-13208-AR

64-66: Amber, w/out logo
C5Z-13208-A

67-68: w/ FoMoCo logo*
C7Z-13208-A



70: Mach 1, w/ Ford logo*
C9WY-13208/9



69-70: w/ Ford logo*
D0Z-13208/9

71-72: Amber, w/ Ford logo*
D1Z-13208/9

WE PROUDLY FEATURE AUTHENTIC MUSTANG REPRODUCTIONS FROM SCOTT DRAKE ENTERPRISES!



PARK LIGHT LENS GASKET



Gray foam gaskets to seal lens against housing.

Park Light Lens Gasket

64-66C5ZZ-13211-A
67-68C7ZZ-13211-A
69C9ZZ-13211-A
70C9WY-13211-A
71-72D1ZZ-13211-A

PARK LIGHT LENS KIT



This kit includes mounting pads, lenses, gaskets, bulbs and mounting hardware.

Park Light Lens Kit

64-66KIT-ELC-2
-------	----------------

PARK LIGHT LENS SCREW



Stainless steel to prevent corrosion.

Park Light Lens Screw

64-66	Set of 4378716-5
-------	------------------------

PARK LIGHT SEAL



Molded sponge, protects paint from chipping.

Park Light Seal

64-66C5ZZ-13217-A/B
-------	---------------------

SIDE LIGHTS & REFLECTORS

MARKER TO BODY SEAL

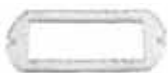

These parts are precision die-cut for a great fit the first time.

Marker To Body Seal

69	Set of 4C9AZ-15A447
70D0ZZ-15A447
71-73D1ZZ-15A447

QUARTER PANEL REFLECTOR



This side marker reflector mounts on the rear of the quarter panel.

Quarter Panel Reflector



68: Late, w/ FoMoCo logo*C8GY-13380-A
68: Early, w/ FoMoCo logo*C8ZZ-13380-A

SIDE MARKER BEZEL

The bezel that surrounds the marker lens.
Side Marker Bezel



68: Early, ready to paint, rear, RH or LHC8ZZ-13381-A
---	-------------------



69: Chrome, front or rear, RH or LHC9AZ-15A440-A
-------------------------------------	--------------------



70: Chrome, rear, LHD0ZZ-15A440-BL
----------------------	---------------------



70: Chrome, rear, RHD0ZZ-15A440-BR
----------------------	---------------------



70: Chrome, front, LHD0ZZ-15A440-L
-----------------------	--------------------

70: Chrome, front, RHD0ZZ-15A440-R
-----------------------	--------------------

71-73: Ready to paint, rear, RH & LHD1ZZ-15A440-C/D
--------------------------------------	----------------------

SIDE MARKER LENS



A quality reproduction with correct red, clear, or amber lens.

Side Marker Lens

69	Rear, RH or LH*C9AZ-15A201-C
69	Front, RH or LHC9DZ-15A215-C
70	Front, RH*D0ZZ-15201-A
70	Front, LH*D0ZZ-15201-B
70	Rear, RH or LH*D0ZZ-15201-R
71-73	Front, RH*D1ZZ-15201-A
71-73	Front, LH*D1ZZ-15201-B
71-73	Rear, RH*D1ZZ-15A201-C
71-73	Rear, LH*D1ZZ-15A201-D

SIDE MARKER LIGHT



Complete pair of assemblies. Ready to install. Correct amber bulbs included.

Side Marker Light

68	RH & LHC8ZZ-15A201-C/D
----	---------	----------------------

SIDE MARKER SOCKET



Replacement light socket for side markers.

Side Marker Socket

69-73D0DZ-15434
-------	-----------------

TAIL LIGHTS & BACK UP LIGHTS

BACK UP LIGHT HOUSING



Great chrome, housings include wiring pigtail. Lenses, gaskets, and bulbs sold separately.

Back Up Light Housing

64-66	RHC5ZZ-15511-A
64-66	LHC5ZZ-15512-A
67-68	RHC7ZZ-15511-BR
67-68	LHC7ZZ-15512-BR

BACK UP LIGHT INSTALLATION KIT



This kit includes mounting pads, lenses, gaskets, bulbs and mounting hardware.

Back Up Light Installation Kit

64-66KIT-ELC-9
-------	----------------

BACK UP LIGHT KIT



This large kit includes backup housings, pads, lenses, gaskets, bulbs and installation hardware.

Back Up Light Kit

64-66KIT-ELC-8
67-68KIT-ELC-7

BACK UP LIGHT LENS

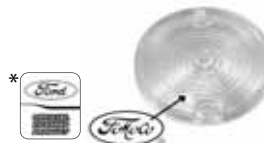

Molded white lenses just like originals. Fits either side.

Back Up Light Lens

64-68	No logoC5ZZ-15514-A
64-68	w/ FoMoCo logo*C5ZZ-15514-AR
69-70	w/ FoMoCo logo*C9ZZ-15514-B

BACK UP LIGHT LENS GASKET



Molded sponge, good fit. Seals lens to housing.

Back Up Light Lens Gasket

65-70C5ZZ-15510-A
-------	-------------------

SHOP WITH CONFIDENCE! WE OFFER SUPERIOR-QUALITY PARTS FOR ALL YOUR MUSTANG RESTORATION NEEDS.

BACK UP LIGHT LENS SCREW



Stainless steel to prevent corrosion.

Back Up Light Lens Screw

64-68 Set of 4 380438-5

BACK UP LIGHT PIGTAIL



The harness that connects to the back up switch on 4 speed cars.

Back Up Light Pigtail

70 4 speed 70-BU-4

BACK UP LIGHT SWITCH



Our back-up switch features a weather sealed U.S. made switch with a zinc plated mounting bracket.

Back Up Light Switch

64-66 4 speed CSZZ-15520-A
 64-66 3 speed CSZZ-15520-C
 67-68 4 speed C7ZZ-15520-A
 67-68 3 speed C7ZZ-15520-C

LICENSE PLATE LIGHT LENS



A nice reproduction to replace those cracked and yellowed originals

License Plate Light Lens

64-74 C4AZ-13564

SEQUENTIAL CONTROL MODULE



These control modules feature variable rate adjusters and color coded wire harnesses.

Perfect for custom tail lights. Note: requires STL-EVF-13350 Variable Flasher (found under "Interior Switches", earlier in the "Electrical & Lighting" category)

Sequential Control Module

65-70 STL-13A366

SEQUENTIAL TAIL LIGHT KIT



These three bulb inserts enhances the brightness of the tail lamps by 200 percent. A simple "drop-in" insert. 65-66 also

available with pre-assembled housings.

Sequential Tail Light Kit

65-66 CSZZ-STL
 65-66 inc. housing & high-temp lenses CSZZ-STL-DLX
 67-68 C7ZZ-STL
 69 C9ZZ-STL
 70 D0ZZ-STL

LED SEQUENTIAL TAIL LIGHT KIT



Sequential LED tail lights. The ultimate custom look. We combined our

new LED tail light panels with our popular sequential light modules and EVF flasher. Our LED panels were designed with sequential operations in mind. You can choose to have either the large LEDs sequence or the rows of small LEDs. No other product offers you this choice. Electrical connectors and instructions are included for quick and easy installation.

Sequential Tail Light Kit, LED

65-66 CSZZ-LED-STL
 67-68 C7ZZ-LED-STL

LED TAIL LIGHT PANEL

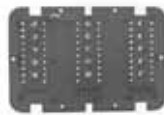

Our LED tail lights feature a combination of large and small LEDs for a unique look. We designed our LED tail lights so they

can be wired to function in several ways. Each bank of LEDs are independant to make a distinction between tail lights and brake/turn signal lights. Made with a 50,000 hour rated life.

Tail Light Panel, LED

64-66 CSZZ-LED
 67-68 C7ZZ-LED

TAIL LIGHT 3 BULB INSERTS



These three bulb inserts enhances the brightness of the tail lamps by 200 percent. A simple "drop-

in" insert. Can be used with or without our sequential controllers.

Tail Light 3 Bulb Inserts

65-66 Twice the brightness CSZZ-STL-13400
 67-68 C7ZZ-STL-13400
 69 C9ZZ-STL-13400
 70 D0ZZ-STL-13400

64-66 TAIL LIGHT BEZEL



These are the best the market has to offer. Available in economy or show-quality versions, and available in our new satin finish

for a custom look. Our 64-66 bezels are also available in a kit with the lens (KIT-ELC-3), see "Tail Light Lens & Bezel Kits" later in this section.

Tail Light Bezel, 64-66

64-66 Economy, chrome CSZZ-13489-A
 64-66 Show-quality, chrome ... CSZZ-13489-AR
 64-66 Show-quality, satin CSZZ-13489-S

TAIL LIGHT LENS & BEZEL KIT



This kit includes 2 daily driver style bezels and lenses, gaskets and mounting hardware.

Tail Light Lens & Bezel Kit

64-66 KIT-ELC-3

67-68 TAIL LIGHT BEZEL



All 67-68 tail light bezels come complete with pads and studs. Available individually or in a kit of 6. Also available in our new

satin chrome finish for a custom look. These are the best on the market. Retaining nuts sold seperately, see Tail Light Bezel Retaining nut later in this section.

Tail Light Bezel, 67-68

67 Chrome C7ZZ-13489-A
 67 Chrome, kit of 6 KIT-ELC-5
 67 Satin, kit of 6 KIT-ELC-5S
 68 Chrome C8ZZ-13489-A
 68 Chrome, kit of 6 KIT-ELC-6
 68 Satin, kit of 6 KIT-ELC-6S

69 TAIL LIGHT BEZEL



This tail light trim is made from original Ford tooling for a perfect fit. Also available with our '69 Tail Light Lens (C9ZZ-13450-A), see "Tail Light Lenses" later in this section.

Tail Light Bezel, 69

69 stainless C9ZZ-13450-S

70 TAIL LIGHT BEZEL



These are beautiful reproductions. Available with a bright chrome finish and black accent lines, or without a chrome

finish for BOSS applications. Available in original Ford tooling or reproduction on chrome versions.

Tail Light Bezel, 70

70 Chrome, RH, USA D0ZZ-13489-A
 70 Chrome, LH, USA D0ZZ-13489-B
 70 w/out chrome, RH D0ZZ-13489-R
 70 w/out chrome, LH D0ZZ-13489-L
 70 Chrome, RH, reproduction D0ZZ-13489-AR
 70 Chrome, LH, reproduction D0ZZ-13489-BR

WE PROUDLY FEATURE AUTHENTIC MUSTANG REPRODUCTIONS FROM SCOTT DRAKE ENTERPRISES!



BILLET TAIL LIGHT BEZEL

Made from a block of billet aluminum. Features black button head screws. A perfect match to our billet gas caps.
Tail Light Bezel, Billet



65-66: w/ accent lines
B-13489-A



65-66: w/out accent lines
B-13489-B

SHELBY TAIL LIGHT BEZEL

High quality reproductions. Made in the U.S.A.
Tail Light Bezel, Shelby



67: Shelby, satin alum.
S7MS-13489



68-70: Shelby/68 Cal Special, chrome
CSZ-13489-A

TAIL LIGHT BEZEL SCREW



Exact copy of the original. Features stainless steel construction.

Tail Light Bezel Screw

64-66 Set of 850398-SK

TAIL LIGHT HOUSING

Tail Lamp Housing w/ wire pigtail.
Tail Light Housing



64: w/ pigtail
C4Z-13434-A



65-66
CSZ-13434-A



67-68: RH & LH
C7Z-13434-A



67: Shelby & Eleanor, ABS plastic housing
S7MS-13434



68: RH & LH
C8ZX-13434

TAIL LIGHT HOUSING MOUNTING NUT



These hard to find nuts are concours correct and feature high-quality zinc plating.

Tail Light Housing Mounting Nut

64-66 Set of 8359606-S8
67-68 Set of 12377523-S

TAIL LIGHT HOUSING GASKET



This gasket goes between the tail light housing and the body of the car on 1964 through 1966 Mustangs.

Tail Light Housing Gasket

64-66C5Z-13420-A
67-68C7Z-13420-A
69C9Z-13420-A

TAIL LIGHT HOUSING SPACER



Cadmium plated for corrosion resistance.

Tail Light Housing Spacer

64-66 Set of 8C5Z-13A547-AK

TAIL LIGHT HOUSING TO BODY SEAL



Thick black molded mounting pads which protect and seal trunk from water and dirt.

Tail Light Housing To Body Seal

67-68C7Z-13520
69C9Z-13520
70D0Z-13520
71-73D1Z-13520

TAIL LIGHT LENS



Excellent injection molded part, with crisp detail and the correct red color.

Tail Light Lens

64-66 EconomyC5Z-13450-A
64-66 w/ FoMoCo logo, concours*C5Z-13450-AR
64-66 High Temperature, for 3 bulb insertsC5Z-13450-PC
65-66 ClearC5Z-13450-CLR
67 Cougar or Shelby*C7WY-13450
67-68 ReproC7Z-13450-AR
67-68 ConcoursC7Z-13450-A
68-70 Shelby/68 Cal special*C5Z-13450-C
69 w/ stainless TrimC9Z-13450-A
70D0Z-13450
71-73 w/ bezel*D1Z-13450

TAIL LIGHT LENS GASKET



Precision die-cut gaskets for hassle-free installation. Made from the original type of material in each case.

Tail Light Lens Gasket

64-66C5Z-13461-B
67 Cougar & ShelbyC7WY-13461
67-68C7Z-13461-A
68-70 Shelby & Cal SpecialC4SZ-13461-A
69C9Z-13461-A

TAIL LIGHT PIGTAIL



These are the correct color code and are just like the originals

Tail Light Pigtail

64-66 LHC40Z-13A408-AL
64-66 RHC40Z-13A408-AR
67 ShelbyS7MS-13A408-A
68 ShelbyS9MS-13A408-A

TAIL LIGHT WIRING HARNESS



Features the correct color coding for left hand tail lights. Exact copy of original weatherproofing rubber plug and connecting terminals.

Tail Light Wiring Harness

64 CP & CV, w/out tail light plugsC4Z-14405-CP
65 CP & CVC5Z-14405-CP
65 FBC5Z-14405-FB
66 CP & CVC6Z-14405-CP
66 FBC6Z-14405-FB
67 CP & FBC7Z-14405-65W
67 CP & FB w/out low fuel warning lightC7Z-14405-65W0
67 CVC7Z-14405-76W
67 CV w/out low fuel warning lightC7Z-14405-76W0
67 AllC7Z-14405-ALL
68 Shelby/Cal Special sequential, aftermarket C8ZX-14289
68 CP & CVC8Z-14405-CPV
68 FBC8Z-14405-FB
69 w/out safety groupC9Z-14405-A
69 w/ safety groupC9Z-14405-B
70 w/out light socketsD0Z-14405-A
70 w/ light socketsD0Z-14405-WS

UNDER-HOOD ELECTRICAL

ALTERNATOR



This is a great addition for a 100% original show car. We have correct versions for FoMoCo, Autolite and Motorcraft. Fan, pulley,

spacer or fasteners NOT included. Note: some castings have an additional upcharge.

Alternator

64-73ALT-10300

ALTERNATOR HARNESS



Attaches to the back of alternator or generator. Plugs into main headlight harness and grounds to the block. Features correct color

coded terminal covers for water proofing electrical connections.

Alternator Harness

64	6 cyl.	C4ZZ-14056-6GN
64	8 cyl.	C4ZZ-14056-8GN
65	6 cyl. w/ gauges	C5ZZ-14056-6WG
65	6 cyl. w/ warning lights	C5ZZ-14056-6WL
65	8 cyl. w/ gauges	C5ZZ-14056-8WG
65	8 cyl. w/ warning lights	C5ZZ-14056-8WL
66	6 cyl.	C6ZZ-14056-6
66	8 cyl.	C6ZZ-14056-8
67-68	6 cyl. w/out tach	C7ZZ-14056-6WO
67-68	BB w/out tach	C7ZZ-14056-BBWO
67-68	BB w/ tach	C7ZZ-14056-BBWT
67-68	SB w/out tach	C7ZZ-14056-SBWO
67-68	SB w/ tach	C7ZZ-14056-SBWT
69	w/out tach	C9ZZ-14056-WOT
69	w/ tach	C9ZZ-14056-WT
70	w/out tach	D0ZZ-14056-WOT
70	w/ tach	D0ZZ-14056-WT
71	w/ instruments	D1ZZ-14056-WI
71	w/out instruments	D1ZZ-14056-WOI
72	w/ instruments	D2ZZ-14056-WI
72	w/out instruments	D2ZZ-14056-WOI

ALTERNATOR TERMINAL COVER



Alternator terminal cover (some applications use two, while others three).

Alternator Terminal Cover

67-70C7ZZ-14056-ATC

BATTERY TRAY MOUNTING KIT



Includes all hardware necessary to mount battery tray to inner fender apron

Battery Tray Mounting Kit

64-66C5ZZ-10732-MK

BATTERY CABLE KIT



Each of these great kits include all three required cables, including

part numbers, proper terminal and post clamp ends. Starter cables are properly shielded from heat. Most M.C.A. approved. Economy versions do not have part numbers, and terminal clamps are similar to originals.

Battery Cable Kit

64	Concours, 8 cyl. *	C4ZZ-14300-8
64-66	Concours, 6 cyl.	C5ZZ-14300-6
64-66	Concours, 8 cyl.	C5ZZ-14300-8
67	Concours, 6 cyl.	C7ZZ-14300-6
67	Concours, 8 cyl.	C7ZZ-14300-8
68-69	Concours, heavy duty, 428CJ	C8ZZ-14300-428
68-69	Concours, 6 cyl.	C8ZZ-14300-6
68-69	Concours, 8 cyl.	C8ZZ-14300-8
68-69	Concours, heavy duty 4 gauge cable *	C8ZZ-14300-HD
70-71	Concours, 6 cyl.	D0ZZ-14300-6
70-71	Concours, 8 cyl.	D0ZZ-14300-8
70-71	Concours, heavy duty 4 gauge cable *	D0ZZ-14300-HD
72-73	Concours, 6 cyl.	D2ZZ-14300-6
72-73	Concours, 8 cyl.	D2ZZ-14300-8
72-73	Concours, heavy duty 4 gauge cable *	D2ZZ-14300-HD

ECONOMY BATTERY CABLE KIT



Quality cables but without concours correct markings. Correct length. Great option for daily drivers.

Battery Cable Kit, Economy

64-66	Economy (no part numbers)	C5ZZ-14300-E
67-70	Economy (no part numbers)	C7ZZ-14300-E

BATTERY CLAMP BOLT KIT



Carriage bolt and two nuts.

Battery Clamp Bolt Kit

64-66C5DZ-10718-MK

AUTOLITE BATTERY COVER



Great at shows for an original look. Fits over the top of any group 24 top-post battery with recessed filler caps.

Battery Cover, Autolite

64-73 Top cover, group 24C1DZ-10655-BC

BATTERY FENDER SHIELD



Rubberized sheet that shields the positive battery post from the inner fender. Kit includes original fasteners.

Battery Fender Shield

66C6ZZ-10760-5

BATTERY HOLD DOWN BOLT KIT



Kit comes complete with J bolts and mounting nuts.

Battery Hold Down Bolt Kit

67-70D0AZ-10756-K

BATTERY HOLD DOWN CLAMP

Heavy duty stamped steel construction with black vinyl coating like the original to prevent corrosion.

Battery Hold Down Clamp



64-66
C5DZ-10718-A



67-70
C5AZ-10718-A

BATTERY HOLD DOWN CLAMP KIT

Includes battery clamp and bolt (or bolts) required to mount battery on tray.

Battery Hold Down Clamp Kit



64-66
C5DZ-10718-KIT



67-70
C5AZ-10718-KIT

WE PROUDLY FEATURE AUTHENTIC MUSTANG REPRODUCTIONS FROM SCOTT DRAKE ENTERPRISES!



BATTERY TRAY

Exactly like the originals. These battery trays are a popular item for restorers since most of the originals have been destroyed by leaking batteries over the years.

Battery Tray



64-66: Black
C5Z-10732-C



64-66: use w/"over the top" style
clamp kit (part number CSAZ-
10718-KIT)
C5Z-10732-D



67-70: Black
C7Z-10732-D



71-73: Black
D1Z-10732-B

DISTRIBUTOR PRIMARY LEAD PIGTAIL



Connects points and
condenser, passes
through distributor
housing and plugs into
distributor side of coil.

Distributor Primary Lead Pigtail

64-66 hi-poC5Z-12127-HP
64-68 6 cyl. C5Z-12127-6PL
64-68 8 cyl. C5Z-12127-8PL

EFI WIRING HARNESS KIT



Our New EFI (Electronic
Fuel Injection) Wiring
Harness Kit is Plug-
And-Play! The wires
are top-quality fire

resistant, printed with the name of the sensor
or terminal they connect to, equipped with
the correct Ford connections and correct
length wires, and each kit comes complete
with easy to understand instructions. These
harnesses fit 302 and 351 Fuel injected HO
motors with mass airflow system. Will not fit
early speed density cars.

EFI Wiring Harness Kit

65-68C5Z-14289-EFI

ENGINE GAUGE FEED HARNESS



Plugs into firewall and
connects original style
oil pressure sending
unit, water temperature

sending unit and coil. Also plugs into heater
blower motor on 1964 - 1966 cars.

Engine Gauge Feed Harness

64 6 cyl.C4Z-14289-6
64 8 cyl.C4Z-14289-8
65 6 cyl. w/ gaugesC5Z-14289-6WG
65 6 cyl. w/ warning lights
C5Z-14289-6WL
65 8 cyl. w/ gauges & 2 speed heater
C5Z-14289-8WG2
65 8 cyl. w/ gauges & 3 speed heater
C5Z-14289-8WG3
65 8 cyl. w/ warning lights & 2 speed heater
C5Z-14289-8WL2
65 8 cyl. w/ warning lights & 3 speed heater
C5Z-14289-8WL3
66 6 cyl.C6Z-14289-6
66 8 cyl.C6Z-14289-8
67-68 6 cyl.C7Z-14289-6
67-68 BBC7Z-14289-BB
67-68 SB w/out tach C7Z-14289-SBWO
67-68 SB w/ tach C7Z-14289-SBWT
68 SB w/ ACC8Z-14289-SBAC
69-70 351W w/ ACC9Z-14289-351AC
69-70 6 cyl.C9Z-14289-6
69-70 BBC9Z-14289-BB
69-70 302, 351W C9Z-14289-SB
70 351 Clev. D0Z-14289-351C
71 429 D1Z-14289-BB
71-72 302D1Z-14289-SB
71-73 351 Clev. D1Z-14289-351

ENGINE TO FIREWALL GROUND WIRE



Original style heavy
gauge black wire with
correct terminals.

Engine To Firewall Ground Wire

65 C5Z-14289-GW

ELECTRIC HORN



Horn, Electric

64-73 High pitch, universalC5Z-13832-A
64-73 Low pitch, universalC5Z-13833-A
65-66 High pitch, concours C5Z-13832-H
65-66 Low pitch, concoursC5Z-13833-L
67-68 High pitch, concours C7Z-13832-H
67-68 Low pitch, concours C7Z-13833-L

OIL PRESSURE EXTENSION LEAD



Oil pressure extension
lead with braided yarn
covering.

Oil Pressure Extension Lead

65-66 w/ gauges C6Z-14289-PT
67-68 Adapter pigtail C7Z-14289-PT

OIL PRESSURE SENDING UNIT

These senders screw into block and activate
warning light when oil pressure is lost or give
accurate reading to oil pressure gauge on cars
equipped with gauges.

Oil Pressure Sending Unit



64-70: 64-65: Warning ligh
67-70: w/ factory tach
B6AZ-9278-A



65-66: w/ oil pressure gauge
67-68 requires adapter (C7Z-14289-PT)
69-73: w/ oil pressure gauge
C9Z-9278-A



67-68: w/out factory tach, w/ spade
connector
C7Z-9278-A

HORN RELAY



Mounts on the radiator
support for generator
equipped cars.

Relay, Horn

64 C4DZ-13583-A

REV LIMITER REPAIR PIGTAIL



Easily repairs damaged
leads.

Rev Limiter Repair Pigtail

69-71D0ZZ-12450-RL

STARTER SOLENOID



This is a good
quality starter
solenoid at
competitive
price.

Starter Solenoid

64-73 AftermarketB6AZ-11450-A
65-66 Concours* C5AZ-11450-A
66 Concours* C6AZ-11450-A
67-71 Concours* C7AZ-11450-A
72-73 Concours* D2AF-11450-A

**SHOP WITH CONFIDENCE! WE OFFER SUPERIOR-QUALITY PARTS
FOR ALL YOUR MUSTANG RESTORATION NEEDS.**

STARTER SOLENOID CABLE BRACKETS



Kit includes two brackets and grommets for routing battery cable between starter and solenoid on inner fender.

Starter Solenoid Cable Brackets
64-73CSZZ-14302-K

VOLTAGE REGULATOR



Now available from Scott Drake! 1965-73 Voltage Regulators without a logo. These quality regulators have a beautiful flat-black finish, and are available

at a lower price than our Concours Voltage Regulators with original logos.

Voltage Regulator
65-73 Black, no logoCSAF-10316-BR

CONCOURS VOLTAGE REGULATOR



We stock these original appearing regulators for all 1964-1973 Mustangs. Features the proper cover and original logos.

Voltage Regulator, Concours
64 Generator, w/FoMoCo logo*C2AF-10505-B
64 Generator, w/Motorcraft logo* C3TZ-10505-B
65 Early 65, w/FoMoCo logo*CSAF-10316-A
65-67 Early 67, black & silver w/Autolite logo*CSAF-10316-B
65-67 w/AC, black & yellow w/Autolite logo*C5TF-10316-A
68-69 w/AC, blue & yellow w/Autolite logo*C8TF-10316-A
68-70 w/out AC, blue & silver w/Autolite logo* ...C8AF-10316-A
70-71 w/out AC, blue & silver w/Autolite logo* ...D0AF-10316-A
72 w/out AC, blue & silver w/Motorcraft logo* D2AF-10316-A
72 w/AC, blue & yellow w/Autolite logo*D2TF-10316-A
73 w/out AC, blue & silver w/Autolite logo* ...D3AF-10316-A
73 w/AC, blue & yellow w/Autolite logo*D3TF-10316-A

VOLTAGE REGULATOR COVER



Generator Regulator Cover

Voltage Regulator Cover
64 Black/blue*C2AF-COVER
64 Black/yellow*C2DF-COVER

VOLTAGE REGULATOR MOUNTING KIT



3 piece kit. Correct screws to mount voltage regulator.

Voltage Regulator Mounting Kit
65-67VRM-C5ZL-404
68VRM-C8ZL-406

VOLTAGE REGULATOR SCREW CAPS



Plastic caps used to cover sharp points on screws that mount voltage regulator. Sold in pairs.

Voltage Regulator Screw Caps
64-66CSZZ-10316-5

WIRE LOOM MOUNTING KIT



Includes all loom straps, anchors, and clips necessary to correctly install wiring looms. These are excellent reproduction that feature excellent fit with concourse appearance.

Wire Loom Mounting Kit
64-66C5ZZ-14000-BK
67C7ZZ-14000-BK
68C8ZZ-14000-BK
69C9ZZ-14000-BK

WIRE CLIPS

UNDERHOOD TURN SIGNAL

WIRING CLIPS



These Scott Drake exclusive wire harness clips are great little reproductions with a

black or bright chrome finish to catch the eye. You'll want to use them all around your car. Set of 5 clips.

Underhood Turn Signal Wiring Clips
67-68 Chrome, set of 5377774-C
67-68 Black, set of 5377774-S

WIRE HARNESS CLIP



Vinyl dipped. Clip is used to hold wiring away from hot engine. Also found on trunk floor.

Wire Harness Clip
64-73356640-S100

EMBLEMS

EXTERIOR EMBLEMS

EMBLEM KIT

* These kits include every correct emblem for the exterior of your car. Barrel clips are also included. We are the premier manufacturer of emblems, no other maker comes close to our quality, variety or packaging.

Emblem Kit



65: GT*
CSZZ-65402828GT



65-66: 6 cyl., FB*
CSZZ-6340282-6K



65-66: 8 cyl., FB*
CSZZ-6340282-8K



65-66: 6 cyl., CP & CV*
CSZZ-6540282-6K



65-66: 8 cyl., CP & CV*
CSZZ-6540282-8K



66: GT*
C6ZZ-65402828GT



67: 6 cyl.*
C7ZZ-6540282200



67: 289*
C7ZZ-6540282289



67: 302*
C7ZZ-6540282302



67: 390*
C7ZZ-6540282390

WE PROUDLY FEATURE AUTHENTIC MUSTANG REPRODUCTIONS FROM SCOTT DRAKE ENTERPRISES!



Emblem Kit



67: GT, 4 speed*
C7Z-6540282-GT



67: GT, automatic*
C7Z-6540282GTA



68: 200, 6 cyl.*
C8Z-6540282200



68: 289*
C8Z-6540282289



68: 302*
C8Z-6540282302



68: 390*
C8Z-6540282390



68: GT*
C8Z-6540282-GT



69-72: All*
C9Z-6540282KIT



FENDER EMBLEM

Fender Emblem



64-65: 260
C4DZ-16228-C



64-66: 289
C30Z-16228-B



64-66: 302
C30Z-16228-302



64-66: 5.0
C30Z-16228-5.0



65-66: High performance, chrome & black
C5Z-16228-B



64-66: High output
C5Z-16228-HO

GT FENDER EMBLEM

Fender Emblem, GT



65: GT
C5ZZ-16098-D



66: GT, porcelain inserts, resembles porcelain style
C60Z-16098-B



67: GTA, automatic
C70Z-16098-A



67: GT, 4 speed
C7Z-16098-A/B



68: GT
C7GY-16098-B

MUSTANG SCRIPT FENDER EMBLEM



Fender Emblem, Mustang Script



64: Mustang, early 4 1/2" version*
C5Z-16098-A



65-66: Mustang*
C5Z-16098-B



65-66: Mustang 2+2*
C5Z-16098-C



68: Mustang script*
C8Z-16098-A



69-73: Mustang script, fender & trunk*
C9Z-16098-A

RUNNING HORSE FENDER EMBLEM



Fender Emblem, Running Horse



64-68: 64-66: All, RH
67-68: 6 cyl., RH*
C5Z-16228-D



64-68: 64-66: All, L
67-68: 6 cyl., LH*
C5Z-16229-B



65-68: 4.6, RH*
C7Z-16228-4.6

65-68: 4.6, LH*
C7Z-16229-4.6

65-68: 5.0, RH*
C7Z-16228-5.0

65-68: 5.0, LH*
C7Z-16229-5.0

Fender Emblem, Running Horse



** 67-68: 289, RH*
C7Z-16228-C



67-68: 289, LH*
C7Z-16229-C



** 68: 302, RH*
C8Z-16228-A

68: 302, LH*
C8Z-16229-A



** 67-68: 351, RH*
C7Z-16228-W

67-68: 351, LH*
C7Z-16229-W

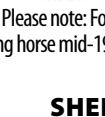

** 67-68: 390, RH*
C7Z-16228-D

67-68: 390, LH*
C7Z-16229-D

** Please note: Ford switched to larger pins on back of the running horse mid-1968, our horses have early version/small pins.

SHELBY FENDER EMBLEM



Fender Emblem, Shelby



64-73: Cobra, RH⁵
F6ZZ-16228-A

64-73: Cobra, LH⁵
F6ZZ-16228-B



67: Shelby GT350⁶
S7MS-16098-A

67: Shelby GT500⁶
S7MS-16098-B



68: 428 Cobra Jet*
S8MS-16098-G



68: Cobra⁵
S8MS-16098-S



68-70: Cobra, fender & roof⁶
C90B-16720-A



69: Flat Cobra snake⁵
C90B-16228-A



69-70: Shelby⁵
S9MS-16098-A



69-70: "428 Cobra Jet" for GT500*
S9MS-16C144-A

GRILLE EMBLEM



Perfect detail. Mounting hardware included.

Grille Emblem



66: Running horse for Shelby, concours*
S2MS-8202-K

69: Running horse*
C9ZZ-8213-AR

70: Running horse*
D0ZZ-8213-A

71-73: Running horse w/ tribar, for Mach 1*
D1ZZ-8213-B

67: "Shelby GT350" grille, dash or deck*
S7MS-16098-C



67: "Shelby GT500" grille, dash or deck*
S7MS-16098-D



69-70: Shelby*
S9MS-16098-A

HOOD LETTERS



"FORD" or "SHELBY" hood letters. Only the best. Includes fasteners.

Hood Letters



64-66: FORD*
C40Z-6240282A/D

67: FORD*
C7AZ-16606-A/D



68-70: SHELBY, chrome, pin version*
S8MS-16606-A/E

65-73: SHELBY, chrome, stick-on*
S8MS-16606-S

65-73: SHELBY, satin, stick-on*
S8MS-16606-SAS

HOOD SCOOP EMBLEM



Emblem to go on the sides of the hood scoop. Sold individually.

Hood Scoop Emblem



69: 351, black & chrome, diecast
C9ZZ-16637-C



69-70: 390, black & chrome, diecast
C9ZZ-16637-D



69: 428, black & chrome, diecast
C9ZZ-16637-B



69-70: Chrome Cobra Jet script*
C9ZZ-16720-A

QUARTER PANEL EMBLEM



Emblems made to factory original specifications by original supplier.

Quarter Panel Emblem



68: California Special*
C8ZX-65291A36-A

ROCKER MOLDING EMBLEM



Beautiful Reproduction made out of Pressure Die Cast Zinc just like the originals. These can be swedged on like the factory did it or we have included speed clips for a quick and easy install. 2 sets required per car.

Rocker Molding Emblem



70: Mach 1*
D0ZZ-16003-K

ROOF EMBLEM



Roof Emblem



69-70: Coiled snake, convex for roof*
C90B-6542508-A



69-70: Pillar ornament, set of 2*
C9ZZ-63517A201A



69-70: Shelby*
S9MS-16229-A

TAIL LIGHT PANEL EMBLEM



This fine reproduction is die-cast zinc

for crisp letters and brushed to duplicate the finish on the original parts. Requires two medium barrel clips (P/N 375890-S).

Tail Light Panel Emblem

65-66 GT 350* S1MS-16098-A

TRUNK & FENDER EMBLEM



Die cast zinc painstakingly deburred and chrome plated. Trouble-free mounting. Sold in sets, includes fasteners or 3 M adhesive.

Trunk & Fender Emblem

65-72: Mustang, pin version*
CSZZ-6540282A/G

65-72: Mustang, Stick on*
CSZZ-6540282-SK

70: Mach 1 Trunk, satin
D0ZZ-6340228-K

70: Mach 1 Trunk, chrome, concours
D0ZZ-6340228-KR

INTERIOR EMBLEMS

DASH PANEL EMBLEM



Excellent reproductions.

Dash Panel Emblem



67: "Shelby GT350" grille, dash or deck*
S7MS-16098-C

67: "Shelby GT500" grille, dash or deck*
S7MS-16098-D



67-68: Running horse, red & silver, very small 7/8"x3/8", adhesive backed*

C7ZZ-65044A90-E



67-68: Running horse tribar emblem w/ base, for dlx. int.*

C7ZZ-65044A90EP

67-68: Running horse tribar emblem w/out base, for dlx. int.*

C7ZZ-65044A90-M

67-68: Running horse base only, for dlx. int.

C7ZZ-65044A90-P



68: GT 500*
S8MS-6304460-C

68: GT 350*
S8MS-6304460-D

68: Cobra Jet*
S8MS-6304460-E



69-70: Mach 1*
C9ZZ-6304460-A



69-70: Mustang script
C9ZZ-6304460-B



69-70: Cobra GT 350*
S9MS-6304460-A



69-70: Cobra Jet GT 500*
S9MS-6304460-B

DOOR PANEL EMBLEM



Beautiful detail. Features bright chrome finish and paint. Hardware included.

Door Panel Emblem

69-70 69 All, 70 dlx.: Running horse*
C9ZB-6520820/3

SHELBY SEAT BELT INSERT EMBLEM

 They are the most authentic and best looking emblems available.

Emblem, Shelby Seat Belt Insert

67: Shelby Cobra[®]
S7MS-63611A73-A



68: Shelby Cobra, gold[®]
S8MS-63611A73-A



69-70: Shelby[®]
DF-306



69-70: Shelby[®]
S9MS-63611A73-A

GLOVE BOX EMBLEM

Pressure die cast, excellent reproductions. Perfect chrome, stripes are painted correct colors.

**Glove Box Emblem**

64-65 Running horse, curved* .C4ZB-65060A14-A

65-66 Running horse, flat* C5ZB-65060A14-A



COBRA INTERIOR EMBLEM

 This small medallion can be used for insertion in shift knobs or other interior applications. 1" diameter.

Interior Emblem, Cobra

64-73 [§]
286-101-A

SILL PLATE EMBLEM

  This is the aluminum emblem which mounts on the center of all scuff plates. Features raised script like original, adhesive backed and protective coating.

Sill Plate Emblem

64-66: Black, Ford logo[®]
C5Z-6513208-T



65-66: Shelby[®]
S1MS-6513208-T





67-73: Blue, Ford logo[®]
C7Z-6513208-T



68-73: Blue, Ford logo[®]
C8Z-6513208-T

STEERING WHEEL EMBLEM

  The most authentic and best looking emblems available.

Steering Wheel Emblem

67: Running horse[®]
C7Z-3649-A



68: Running horse[®]
C8Z-3649-AR



68: Shelby Cobra[®]
S8MS-3649-A



69-70: Shelby Cobra[®]
C9MS-3649-A



69-73: For use on 2-spoke wheel
C9Z-3649-S

ENGINE

AIR CLEANERS & COMPONENTS

AIR CLEANER



Air Cleaner

These are complete air cleaner assemblies. Includes top, bottom and filter element.



64-71: hi-po, economy, chrome top w/ blue bottom, inc. 289 HiPo decal
C5ZZ-9600-W



64-65: V8, Chrome/gold, concours, chrome lid & filter, inc. 289 HiPo decal
C5ZZ-9600-G



65-67: V8, Chrome/blue, concours, chrome lid & filter, inc. 289 HiPo decal
C5ZZ-9600



64-73: 6 cyl., 200-250 w/ Autolite, 1.89" opening, concours, chrome lid & filter
C4DZ-9600



64-73: 6 cyl., 1.89" opening
C4DZ-9600-W



64-73: V8, 14" alum. Finned
C5ZZ-9600-AFK



64-73: 14" alum. Finned, top only
C5ZZ-9600-AFT



64-73: Oval shape w/ Mustang logo*
C5ZZ-9600-M



64-73: Oval shape w/ COBRA letters, single carb.^s
S1MS-9600-A



64-66: 6 cyl. w/ open emissions
C5ZZ-9600-A



65-66: 6 cyl. closed emissions
C5ZZ-9600-B



66-67: Stock, 260 & 289, closed emissions
C5ZZ-9600-Y

65-67: Stock, 260 & 289 open emissions
C5ZZ-9600-Z

67: 6 cyl.
C7ZZ-9600-A

AIR CLEANER BOX



Air cleaner body and lid only.

Air Cleaner Box

71-73 8 cyl. Ram Air D1ZZ-9600-BOX

HOOD PLENUM



This is the device that channels the air from the hood scoops to the air cleaner on 1971 through 1973 Mustangs.

Hood Plenum

71-73 D1ZZ-16613-A

AIR CLEANER ELEMENT

Quality air filters designed to meet or exceed the specs of the original factory filter.

Air Cleaner Element



64-73: Oval shape, reproduction
S1MS-9601-A



64-74: hi-po, concours
B7SZ-9601-A



64-74: Economy
B7SZ-9601-R

BILLET AIR CLEANER KNOB



Here's another nice billet product from Scott Drake. Our air cleaner knob matches our billet radiator cap B-8100 and

our billet master cylinder cap B-2162-A. All are beautifully machined and have a soft etched finish. Available with or without the screw hole drilled through. 1/4" x 20 threads.

Air Cleaner Knob, Billet

64-73 Solid B-358871-A
64-73 w/ hole B-358871-B

AIR CLEANER LID GASKET



New sponge rubber seal which adheres to the inside top of the air cleaner lid.

Air Cleaner Lid Gasket

64-73 6 cyl. C4DZ-9673
65-67 289, 302 C5ZZ-9673
68-73 289, 302, 351 & 67 390 C8ZZ-9673

AIR CLEANER TO CARBURETOR STUD

Zinc plated for years of service.

Air Cleaner To Carburetor Stud



64-67: 4V 4 1/2" stud, 1/4" x 20 carb threads
37005-S



64-68: 2V 4 1/8" stud, 5/16" x 18 carb threads
370971-S

SHAKER AIR CLEANER ASSEMBLY



Fiberglass construction. Features chrome internal air cleaner lid, shaker air cleaner seal and authentic decal. Filter included. See sheet metal section for

hood trim ring. C9ZZ-9600-BB is more than a 1/2" shorter to allow more hood clearance. Neither version includes a flapper plate.

Shaker Air Cleaner Assembly

69-70 BB & Boss 302 C9ZZ-9600-BB
69-70 SB stock intake C9ZZ-9600-S

SHAKER AIR CLEANER BRACKET

Exact reproductions that support scoop to air-cleaner base plate.

Shaker Air Cleaner Bracket



69-70: 428 Cobra Jet
D0ZZ-9A627-C



70: Boss 302
D0ZZ-9A627-A



70: 351 Clev.
D0ZZ-9A627-B

SHAKER AIR CLEANER SEAL



This rubber seal fits under the shaker intake to help seal around the hood opening.

Shaker Air Cleaner Seal

69-70 orig. Ford* C9ZZ-9B624
69-70 Reproduction C9ZZ-9B624-C

SHAKER FLAPPER PIVOT ROD



The rod that controls the flapper plate.

Shaker Flapper Pivot Rod

69-70 w/ clips C9ZZ-9600-PR

WE PROUDLY FEATURE AUTHENTIC MUSTANG REPRODUCTIONS FROM SCOTT DRAKE ENTERPRISES!



SHAKER FLAPPER PLATE



Controls air flow to carburetor.

Shaker Flapper Plate

69-70 Stamped steel C9ZZ-9600-FL

SHAKER INTERMEDIATE PLATE



Stamped from Steel like originals. requires drilling 3 holes to attach to air cleaner base and 2 holes for pivot rod. Depending

on engine size minor modification may be required to make work.

Shaker Intermediate Plate

69-70 Stamped steel C9ZZ-9600-IP

ALTERNATOR COMPONENTS

ALTERNATOR BELT



All belts are constructed by the original manufacturer and made in the U.S.A. Each belt is concourse correct

with all the authentic inked markings. All belts are approved by Mustang Club of America and are recognized as concourse correct

Alternator Belt

65 200 w/out AC C5DE-8620-D

65-67 289 hi-po C5OE-8620-K

65-69 260, 289, 302, 66-67 w/out AC C4TE-8620-S

66-67 289 w/ AC C4AE-8620-A

66-70 200 w/out AC C5DE-8620-C

67 390, 428 w/out AC C4AE-8620-D

68-69 390 GT, 428CJ w/out AC C6AE-8620-L

69-70 428CJ w/out AC C4AE-8620-H

70 302 Boss, w/ P/S DOZE-8620-E

70 302, Boss 302, 351, 351C w/out P/S DOZE-8620-F

70-71 302, 351C w/ P/S or AC C4AE-8620-B

ALTERNATOR BRACKET

OEM style brackets. Available in bright chrome or black.

Alternator Bracket



65-73: SB, black
CSZZ-10145/51BK



65-73: SB, chrome
CSZZ-10145/51-K



69: 351 Windsor, upper head bracket
C9ZZ-10145-A

ALTERNATOR FAN



Made from original dies. Plated gold zinc dichromate.

Alternator Fan

65-69 Gold zinc dichromate ... C5AZ-10A310-B

ALTERNATOR FAN AND PULLEY KIT



Chrome alternator pulley and fan. Includes lockwasher and nut.

Alternator Fan and Pulley Kit

65-73 Chrome, 4 piece kit ... C5ZZ-10A310/44C

ALTERNATOR MOUNTING KIT



Concourse correct mounting hardware. Cadmium plated with correct "F" marking. Spacer not included.

Alternator Mounting Kit

65-67 289, 302, 390 & 428 C5DZ-10346-MK

67-70 390 & 428 C7ZZ-10346-MK

68-69 289 & 302 w/out smog C8ZZ-10346-MK

ALTERNATOR PULLEY

Made by Scott Drake from the original Ford print. Features part number stamped in to the face of the pulley just like the original.

Alternator Pulley



65-73: Single
C5AZ-10344-K



65-73: Dual
C5AZ-10344-L

HI PO ALTERNATOR PULLEY



Made by Scott Drake from the original Ford print. Features part number stamped in to the face of the pulley

just like the original. Large diameter pulley was original equipment on 289 HiPo's and Boss 302's. Prevents damage to alternator.

Alternator Pulley, Hi Po

64-73 Chrome CSAF-10A352-S

65-73 Black steel CSAF-10A352-C

65-73 Clear anodized alum. . CSAF-10A352-CA

65-73 Yellow steel CSAF-10A352-H

65-73 Gold anodized alum. .. CSAF-10A352-HA

ALTERNATOR PULLEY LOCK NUT & WASHER



Concours correct mounting hardware.

Alternator Pulley Lock Nut and Washer

64-73 Gold C5DZ-10346-NG

65-73 Silver C5DZ-10346-NS

ALTERNATOR SPACER



This spacer is made from extruded aluminum and anodized the correct color.

Alternator Spacer

64-69 289 & 302, Gold C5AE-10A370-A

66-70 390 & 428, Pink C5AE-10A370-B

70-73 351C, Silver D00F-10A370-A

CYLINDER HEAD COMPONENTS

HEAD GASKET



These are the highest quality U.S. made gaskets. Made by FELPRO®.

Head Gasket

64-70 6 cyl. C30Z-6051-A

64-73 SB C3AZ-6051-C/G

67-70 390, 428 C7ZZ-6051-D

69 351W C9ZZ-6051-W

70-73 351 Clev. DOZZ-6051-C

HEAD GASKET KIT



This set includes head gaskets, intake manifold, exhaust manifold, carb, base

plate, water inlet, valve cover, valve stem seals. Made by FELPRO®.

Head Gasket Kit

64-70 6 cyl. C30Z-6051-AK

64-73 SB C3AZ-6051-C/GK

67-70 390, 428 C7ZZ-6051-DK

69 351W C9ZZ-6051-WK

70-73 351 Clev. DOZZ-6051-CK

VALVE STEM SEAL



Made by FelPro out of long lasting polycrylate for years of service.

Valve Stem Seal

64-70 170, 200 intake & exhaust . C3DZ-6571-B

64-73 260, 289, 302 exhaust CSZZ-6571-E

64-73 260, 289, 302 & intake C5ZZ-6571-I

67-70 390, 428 intake & exhaust . C7ZZ-6571-D

69 351W intake & exhaust ... C9ZZ-6571-W

70-73 351 Clev. exhaust DOZZ-6571-E

70-73 351 Clev. intake DOZZ-6571-I

DISTRIBUTOR & TIMING

COIL

Stock to super high power, we have a coil for your needs.



- Coil
- 64-73: Yellow top (20,000 v)
B6A-12029-B
 - 64-73: Pertronix, Chrome (40,000 v)
IGN-40001
 - 64-73: Pertronix, hi-po, chrome (45,000 v)
IGN-40001-2
 - 64-73: Pertronix, black (40,000 v)
IGN-40011
 - 64-73: Pertronix, hi-po, black (45,000 v)
IGN-40011-2

COIL BRACKET



We made our concours bracket capable of holding the smaller coils on the market today as well the original coils. Zinc plated hex head bolt and nut included.

Our bracket is also available in polished stainless steel. Chrome version is a universal bracket that does not resemble original.

Coil Bracket

- 64-73 Black C4DZ-12043-A
- 64-73 Stainless C4DZ-12043-S
- 64-73 Chrome, universal IGN-10002

DISTRIBUTOR



Designed to provide maximum ignition performance and easy installation at an affordable price. Now you can upgrade your outdated points or stock

electronic distributor with a performance proven distributor that features the patented Ignitor II module and a CNC machined 6061 T-6 polished billet housing and deck. Comes with a factory configured performance curve with additional spring sets for custom curving.

Distributor

- 64-73 w/ vacuum IGN-1307
- 64-73 No vacuum IGN-1308

FLAME-THROWER DISTRIBUTOR



Designed for the enthusiast looking for a simple and dependable high energy distributor. Drop in and connect two wires. it's that simple. features 50,000 volt Flame-Thrower coil

that delivers twice the energy across the spark gap compared to a stock HEI distributor.

Distributor, Flame-Thrower

- 63-84 Street or strip IGN-D1352
- 63-84 Race only IGN-D1372

DISTRIBUTOR CAP



V8 version has Brass contacts-Exact copy of original cap.

Distributor Cap

- 55-72 6 cyl., Motorcraft 7HA-12106-A
- 55-74 8 cyl. B7A-12106-A

DISTRIBUTOR CLAMP



Features flawless chrome finish and chrome mounting bolt. Will work for most Ford & Lincoln-Mercury applications.

Distributor Clamp

- 64-73 C5Z-12270

DISTRIBUTOR TUNE UP KIT



Our tune-up kits have all the required replacement parts. Included in each kit are: rotor, condenser and points.

Distributor Tune Up Kit

- 64-73 260, 289, 302, 351, 390 ...COTZ-12000-A

DISTRIBUTOR VACUUM ADVANCE

These vacuum advances are made in the U.S.A. by an OEM supplier. Zinc plated to prevent corrosion. Cross reference sheet included for correct application.

Distributor Vacuum Advance



- 64-65: Early 8 cyl.
DD-9



- 65-67: 6 cyl.
DD-12



- 65-71: 8 cyl.
DD-190



- 68-71: Dual vacuum
DD-377

DISTRIBUTOR VACUUM ADVANCE LINES



Quality one piece lines with correct fittings.

Distributor Vacuum Advance Lines

- 64-65 170-6, steel MVL003
- 64-65 170-6, stainless MVL003S
- 64-68 SB, steel MVL001
- 64-68 SB, stainless MVL001S
- 66-68 200-6, steel MVL002
- 66-68 200-6, stainless MVL002S

HARMONIC DAMPER



High performance or stock specifications, these are quality dampers.

Harmonic Damper

- 64-68 5.0 conversion, 3 bolt C5AZ-6316-5.0
- 64-68 289 except hi-po C5AZ-6316-B
- 64-67 289 hi-po C5AZ-6316-B
- 65-67 200 6 cyl. C2DZ-6312-A
- 68 302 3 bolt C8AZ-6316-A
- 68-74 BB C8AZ-6316-B
- 69 302, 3 bolt w/ lip C90E-6316-D
- 69 351W, 3 bolt C90Z-6316-A
- 69 5.0 & 5.8 conversion, 3 bolt, w/ lip D2TE-6316-5.0
- 70-73 302, 4 bolt D2OZ-6316-A

PERFORMANCE HARMONIC

DAMPER



Made from extremely tough nodular iron. Suitable for all street applications and mild racing applications. Designed for revving as high as 6500 rpm. Features gloss black

finish with three sets of white timing marks.

Harmonic Damper, Performance

- 64-79 289, 302, 28 oz. 80006
- 66-73 390, 428 80009

HARMONIC DAMPER SPACER



Correct spacers to fit 80006 & 80007.

Harmonic Damper Spacer

- 64-79 351W 81006

WE PROUDLY FEATURE AUTHENTIC MUSTANG REPRODUCTIONS FROM SCOTT DRAKE ENTERPRISES!



IGNITOR CONVERSION



Never change points again, plus increase horsepower and improve fuel economy. Fits entirely under the distributor cap,

with no "black box" to clutter the engine compartment. Installs in minutes, and is completely hidden. Other benefits: Test results show the Ignitor delivers twice the voltage to the spark plugs. No limits to coil and spark energy (spark energy is limited by the coil). A 2:1 improvement over "point type" systems in current fall time. Stable timing with no need for periodic adjustments. Increase spark plug life by 2 to 3 times. No contacts to burn, pit and corrode. No moving and rubbing parts to wear out. Better foul weather performance.

Ignitor Conversion

- 64-72 8 cyl., dual pointIGN-1281-D
- 64-72 8 cyl., dual point w/ vacuum advance
IGN-1281-DV
- 64-73 8 cyl.IGN-1281
- 64-73 6 cyl.IGN-1261
- 64-67 6 cyl. w/ round push rod for vacuum advance IGN-1266

HIGH POWER IGNITOR CONVERSION



The Ignitor II takes the Ignitor a step further by adding a powerful new microcontroller, that controls the dwell period, for the best

possible spark over the entire RPM range. Ignitor II offers enhanced performance levels only found in more expensive box type ignition systems. Compared to point type systems Ignitor II develops on average 4 times more available energy between 3,000 and 5,000 RPM, and 2 times more available plug voltage. Higher RPM performance is improved when used with the Flame-Thrower II super low resistance 45,000 volt coil.

Ignitor Conversion, High Power

- 64-73 hi-po 6 cyl.IGN-1261-2
- 64-73 hi-po 8 cyl.IGN-1281-2

SPARK PLUG WIRE SEPERATOR

Keeps spark plug wires neat and orderly.

Spark Plug Wire Seperator



64-73: Attach to wires
B6A-12297-A



64-73: Mounts on valve covers
B8Q-12297-A

SPARK PLUG WIRE SEPERATOR SET

These Spark Plug Wire Separators are made of high-quality ABS plastic. Constructed to hold both standard 7mm and 8mm high-performance spark plug wires. Fits directly on valve cover clip. 4 piece sets.

Spark Plug Wire Seperator Set



64-73: Black
B6AB8Q-12297-KA



64-73: Blue
B6AB8Q-12297-KB



64-73: Red
B6AB8Q-12297-KR

AFTERMARKET SPARK PLUG WIRE SETS



Our aftermarket wire sets are made from premium radio suppression or wire core cables as per factory specifications.

Spark Plug Wire Sets, Aftermarket

- 64-73 Motorcraft, 6 cyl.C50Z-12259-AMC
- 64-73 Motorcraft, V8 except 390
C50Z-12259-BMC
- 67-73 Motorcraft, BBC50Z-12259-CMC

CONCOURS SPARK PLUG WIRE SETS



These original type wire sets are made from premium radio suppression core cable. Original appearance and

length-matched. Boots are color correct.

Spark Plug Wire Sets, Concours

- 64-66 6 cyl.C50Z-12259-A
- 64-66 8 cyl.C50Z-12259-B
- 65-66 289 hi-poC50Z-12259-K
- 66 289 w/ smogC60Z-12259-A
- 67 6 cyl.C70Z-12259-A
- 67 289 w/out smogC70Z-12259-B
- 67 390, 428 w/out smogC70Z-12259-C
- 67 289 w/ smogC70Z-12259-F
- 67 390 w/ smogC70Z-12259-G
- 67-68 428 police interceptor, GT500 .C70Z-12259-D
- 68 289, 302 w/ smogC80Z-12259-E
- 68-69 390, 428 w/out smogC80Z-12259-C
- 68-70 390, 428 w/ smogC80Z-12259-D
- 68-71 6 cyl.C80Z-12259-A
- 68-71 289, 302 w/out smogC80Z-12259-B
- 69-70 Boss 302C90Z-12259-A
- 69-71 351WC90Z-12259-B
- 70-71 351 Clev.D0ZZ-12259-A
- 71 429, 429CJD1ZZ-12259-A

PERTRONIX SPARK PLUG WIRE SETS



These low resistance, high performance wire sets feature two current paths. One path is spiral wound stainless steel alloy and

the other is a carbon impregnated fiberglass center core. Other features include low 500 ohm per foot resistance. Silicone jackets used to resist high temperatures, moisture, oil and chemicals. EPDM rubber inner insulation for superior heat resistance and prevention of arching and voltage leaks. Fiberglass reinforcing braid for added strength and flexibility. Available in red, blue and black, these spark plug wires come with a lifetime warranty and are made in the U.S.A.

Spark Plug Wire Sets, Pertronix

- 64-73 8mm BlackIGN-808280
- 64-73 8mm BlueIGN-808380
- 64-74 8mm RedIGN-808480

TIMING CHAIN SETS



Quality timing chain sets in both high performance and stock configurations. Note: C5ZZ-6268-RK will not fit factory 289 HiPo

when using "hatchet" counter balance.

Timing Chain Sets

- 64-73 SB, stock replacementC5ZZ-6268-K
- 64-73 SB roller, hi-poC5ZZ-6268-RK
- 67-70 BB, stockC7ZZ-6268-K
- 67-70 Roller, BB, hi-poC7ZZ-6268-RK
- 70-73 351 Clev, stockD0ZZ-6268-K

VACUUM LINE HOSE KIT



All vacuum hoses have correct color striping with repeating "MX" markings.

Manufactured by original suppliers. Markings are very durable and don't come off easily.

Vacuum Line Hose Kit

- 68-70 BB, manualC8ZZ-12226-A
- 68-70 BB, auto.C8ZZ-12226-B
- 68-73 SB, dual diaphragmC8ZZ-12226-C
- 68-73 SB, single diaphragmC8ZZ-12226-D
- 69-70 Boss 302C9ZZ-12226-A
- 69-70 Boss 429C9ZZ-12226-B
- 70-73 351 Clev. w/ dual diaphragm
D0ZZ-12226-A
- 70-73 351 Clev. w/ single diaphragm
D0ZZ-12226-B
- 71 Boss 351D1ZZ-12226-A
- 71 429 Cobra Jet, manualD1ZZ-12226-B
- 71 429 Cobra Jet, auto.D1ZZ-12226-C
- 71-73 All Ram Air carsD1ZZ-12226-D

VACUUM MODULATOR LINE



Runs from intake manifold to modulator on transmission. Includes rubber attaching hose on each end.

Vacuum Modulator Line

64-65	C-4, V8, steel	MVT002
64-65	C-4, V8, stainless	MVT002S
64-68	6 cyl., steel	MVT003
64-68	6 cyl., stainless	MVT003S
65-66	C-4, steel	MVT001
65-66	C-4, stainless	MVT001S
67-69	C-4, V8, steel	MVT004
67-69	C-4, V8, stainless	MVT004S
68-69	C-6, V8, steel	MVT007
68-69	C-6, V8, stainless	MVT007S
71-73	C-4, V8, steel	MVT005
71-73	C-4, V8, stainless	MVT005S
71-73	C-6, 351, steel	MVT006
71-73	C-6, 351, stainless	MVT006S

ENGINE BELTS

For Alternator Belts: See "Alternator" section earlier in the Engine category

AIR CONDITIONER BELT



All belts are constructed by the original manufacturer and made in the U.S.A. Each

belt is concourse correct with all the authentic inked markings. All belts are approved by Mustang Club of America and are recognized as concourse correct.

Air Conditioner Belt

65-69	SB 65-67 & 69 before 1-23-69*	C4ZE-8620-B
67-68	SB after 1-2-67*	C7OE-8620-D
70	302, 351W, 351 Clev.*	D0AE-8620-H

GENERATOR BELT



All belts are constructed by the original manufacturer and made in

the U.S.A. Each belt is concourse correct with all the authentic inked markings. All belts are approved by Mustang Club of America and are recognized as concourse correct.

Generator Belt

64	hi-po w/ generator*	C2OE-8620-AC
64	SB w/ generator*	C4SE-8620-C

POWER STEERING BELT



All belts are constructed by the original manufacturer and made in the U.S.A. Each

belt is concourse correct with all the authentic inked markings. All belts are approved by Mustang Club of America and are recognized as concourse correct.

Power Steering Belt

64-65	260/289 w/ generator & Eaton pump*	C3OE-8620-B
-------	------------------------------------	-------------

65	260/289 w/ AC*	C5AE-8620-E
65	200 w/out AC & Ford pump*	C5DE-8620-E
65-66	260/289 w/ Ford pump, w/out AC*	C5AE-8620-U
66	289 w/ AC*	C6OE-8620-D
67	390/428 w/out AC*	C5AE-8620-L
67	289 w/out AC*	C6TA-8620-J
67-68	289 w/ AC*	C6OE-8620-A
68-69	302/351W w/out AC & before 10-2-69*	C6DE-8620-G

68-69	390/428CJ/428SCJ w/out AC & before 10-2-69*	C8SE-8620-B
-------	---	-------------

68-70	390GT/428CJ/428SCJ w/ AC*	C6AE-8620-T
69-70	390/428CJ/428SCJ w/out AC & after 10-2-69*	C9OE-8620-D

70	Boss 302 w/out AC & 351W w/ AC*	D0ZE-8620-A
----	---------------------------------	-------------

70	351W w/out AC*	D0ZE-8620-B
----	----------------	-------------

70-71	351 Clev./429 w/ AC & 302 w/out AC*	D0AE-8620-K
-------	-------------------------------------	-------------

70-71	351C/351 Boss/429 w/out AC*	D0OE-8620-A
-------	-----------------------------	-------------

SMOG PUMP BELT



All belts are constructed by the original manufacturer and made in the U.S.A. Each

belt is concourse correct with all the authentic inked markings. All belts are approved by Mustang Club of America and are recognized as concourse correct.

Smog Pump Belt

68-70	428 Cobra Jet, & Super Cobra Jet w/out AC*	C6OE-8620-B
-------	--	-------------

69-70	428 Cobra Jet & Super Cobra Jet w/ AC*	C8ZE-8620-C
-------	--	-------------

70	428 Cobra Jet w/out AC*	D0DE-8620-A
----	-------------------------	-------------

70	Boss 302*	D0ZZ-8620-A
----	-----------	-------------

ENGINE BLOCK COMPONENTS

ENGINE MOUNT



Replacement motor mounts. Bonded rubber and steel.

Engine Mount

64-65	260, 289 std, RH	C3AZ-6038-G
64-65	260, 289 std, LH	C3AZ-6038-H
64-66	6 cyl. RH	C4UZ-6038-A
64-66	6 cyl. LH	C4UZ-6038-B
66-72	289, 302, 351W, 69-70 351C, RH or LH ...	DOZZ-6038-B
67-69	200, NOT CV, RH or LH	C3DZ-6038-E
67-70	390, 428 rubber mount	D1ZZ-6038-A

HIGH PERFORMANCE ENGINE MOUNT

Engine Mount, High Performance



64-65: Factory 289, Hi-Po
C2OZ-6039



64-65: Factory 289, Hi-Po
C5ZZ-6038-A

ENGINE MOUNT BRACKET

Bolts to frame and motor mount attaches to it. Note: Ford improved their motor mount design in 1966. Our 1966 version is an excellent upgrade for 1964 - 1965 V8 cars and a must for 6 cylinder conversions over to V8 (requires D0ZZ-6038-B mounts).

Engine Mount Bracket



64-65: 8 cyl.
C3DZ-6028/9-C



66-70: 289, 302, 351
C6ZZ-6028/9-A



67-70: 390, 428
C7ZZ-6028-KIT



67-70: 390, 428 engine brackets
C7ZZ-6046-PR

WE PROUDLY FEATURE AUTHENTIC MUSTANG REPRODUCTIONS FROM SCOTT DRAKE ENTERPRISES!



ENGINE MASTER FASTENER KIT



These are really great kits. They include exact original equipment hardware. Again these are not off the shelf generic fasteners, but have been re-tooled and are made identical to the original. Each kit includes hardware to attach the following: valve covers, air cleaner, intake manifold, oil pan, timing cover, water pump, crank pulley, thermostat housing, heat shield, distributor, carburetor, exhaust manifolds, fuel

pump, oil filter adapter, engine tag and ignition coil.

Engine Master Fastener Kit

64	SB w/ generator & AC	EMK-C20E-336
64	SB hi-po w/ generator & AC	EMK-C30E-323
64-65	6 cyl.	EMK-CODE-319
64-65	SB w/ generator, inc. exhaust locks	EMK-C20E-322
65	SB 289 w/ alum. water pump & alternator	EMK-C50E-559
65	SB 289 w/ AC	EMK-C50E-560
65	SB 289 hi-po w/ alum. water pump & alternator	EMK-C50E-561
65	SB 289 w/ cast iron water pump & alternator	EMK-C50E-812
65	SB 289 hi-po w/ cast iron water pump & alternator	EMK-C5ZE-1067
65	SB GT-350	EMK-S1ME-1184
66	6 cyl.	EMK-C6DE-320
66	SB 289 w/ cast iron water pump & AC & Ramp-locs	EMK-C60E-337
66	SB GT-350	EMK-S2ME-1185
66-67	SB 289 w/ cast iron water pump & Ramp-locs	EMK-C60E-324
66-67	SB 289 hi-po w/ cast iron water pump & Ramp-locs	EMK-C60E-325
67	BB 390 GT	EMK-C70E-330
67	SB 289 w/ AC	EMK-C70E-562
67	SB GT-350	EMK-S7ME-1186
67	BB GT-500	EMK-S7ME-331
68	SB 289, 302	EMK-C80E-326
68	BB 428 Cobra Jet	EMK-C80E-333
68	SB 289, 302 w/ AC	EMK-C80E-338
68	SB GT-350	EMK-S8ME-1187
68	BB GT-500KR & 428 Cobra Jet	EMK-S8ME-382
68	BB GT-500	EMK-S8ME-677
68-69	BB 390 GT	EMK-C80E-332
68-70	6 cyl.	EMK-C8DE-321
69	SB 302	EMK-C90E-1126
69	SB 351	EMK-C90E-1128
69	SB 351 w/ AC	EMK-C90E-1129
69	SB Boss 302	EMK-C9ZE-1180
69	SB 302	EMK-D00E-1130
69-70	BB 429 & Boss 429	EMK-C9AE-1182
69-70	SB GT-350 w/out AC	EMK-C90E-1188
69-70	BB 428 Cobra Jet & Super Cobra Jet	EMK-C90E-334
69-73	6 cyl. 250	EMK-C9DE-342
69-73	SB 302 w/ AC	EMK-C90E-1127
70	SB 351W	EMK-D00E-1132
70	SB Boss 302	EMK-D0ZE-1181
70-71	SB 351 Clev. w/ 2 barrel carb.	EMK-D00E-1175
70-71	SB 351 Clev. w/ 4 barrel carb.	EMK-D00E-1176
71	Boss 351	EMK-D00E-1177
71	BB 429, 429 Cobra Jet & Super Cobra Jet	EMK-D00E-1183
72-73	SB 351 Clev. w/ 2 barrel carb.	EMK-D20E-1178
72-73	SB 351 Clev. w/ 4 barrel carb.	EMK-D20E-1179

FULL SET ENGINE GASKET



Our most complete quality Fel-Pro gaskets set. Includes the following: Head gaskets, exhaust gaskets, exhaust

flanges, valve stem seals, water outlet, carb base plate, oil pan, fuel pump, timing chain cover and water pump gaskets.

Engine Gasket, Full Set

64-70	6 cyl.	FS-7916PT2
64-73	SB	FS-8548PT16
67-70	BB	FS-8554PT
69	351W	FS-8548PT2
69-70	Boss 302	FS-8346PT
70-73	351 Clev.	FS-8347PT

TIMING COVER



A quality after market replacement timing chain cover for cast iron pumps. 289, 302, 351W. Will not fit original-style aluminum water pumps.

Timing Cover

65-67	Concours, molded in Pointer	C4AZ-6019-B
66-73	Requires bolt on pointer	C50Z-6019-B

TIMING COVER GASKET

Everything you need, also includes crank shaft seal and sleeve.

Timing Cover Gasket



64-73: 6 cyl.
CODE-6020-C



64-73: SB
C40Z-6020-A

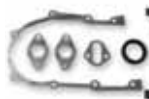

67-73: BB
C9ZZ-6020-D



70-73: 351 Clev.
D0ZZ-6020-C

TIMING COVER MOUNTING KIT



Concourse correct fasteners, mounts timing chain cover to engine.

Timing Cover Mounting Kit

64	260, 289 w/ generator	TCC-C20E-488
64-65	6 cyl. w/ generator	TCC-CODE-499
64-67	289 w/ alternator	TCC-C50E-489
65-70	6 cyl. w/ alternator	TCC-C5DE-500
68-69	289, 302 & 351	TCC-C80E-490

TIMING POINTER



Stamped steel pointer mounts to timing chain cover. Black zinc-plated. Includes mounting screw. Fits 289, 302, 351W

Timing Pointer

64-73 C20Z-6023-B

INTAKE MANIFOLD COMPONENTS

INTAKE MANIFOLD



Add to your cars performance and beauty with these highly polished or satin finished intake manifolds.

Intake Manifold

64-93 Polished, Crosswind C30Z-9424-CWP
 64-93 Satin, Crosswind C30Z-9424-CWS
 64-93 Polished C30Z-9424-P
 64-93 Satin C30Z-9424-S

INTAKE MANIFOLD BOLT KIT



Concourse correct with the exact head markings. Not an off the shelf generic copy. These are 100% correct or your money back!

Intake Manifold Bolt Kit

64-67 260, 289 IMB-C40E-478
 67 GT500 IMB-C3AE-493
 67-68 390, 428 IMB-B8AE-475
 68 GT500 IMB-S8ME-477
 68-69 289, 302 IMB-C80E-479
 69 351W IMB-C90E-1131
 69 Boss 302 IMB-C9ZE-1306
 69-70 Boss 429 IMB-C9AE-1376
 69-70 390, 428 IMB-C90E-476
 70 Boss 302 IMB-D0ZE-1320
 70-73 351 2V IMB-D00E-1313
 70-73 302 IMB-D00E-1123
 70-73 351 Clev. 4V IMB-D00E-1321

INTAKE MANIFOLD GASKET



Intake Manifold Gasket

64-73 SB C3AZ-9441-A
 67-70 BB C7ZZ-9441-D
 69 351W C9ZZ-9441-W
 70-73 351 Clev. w/ 2 barrel D0ZZ-9441-C2
 70-73 351 Clev. w/ 4 barrel D0ZZ-9441-C4

INTAKE MANIFOLD WASHER KIT



Very special aluminum washers which are rubber coated. These are the correct ones. Helps eliminate oil leaks. 12 piece kit.

Intake Manifold Washer Kit

64-67 IMW-C40E-702

OIL RELATED PARTS

OIL CAP



These factory caps offer you very similar features as the old originals, plus quality you would expect from Motorcraft.

Oil Cap



64-66: Black, no tube, open, push-on
 CSZZ-6766-FR



64-66: Black, closed w/ elbow, push-on*
 CSZZ-6766-HR



64-66: Chrome, closed w/ elbow, push-on
 CSZZ-6766-IR



64-68: FoMoCo logo, closed, push-on*
 B6AZ-6766-B



64-68: Chrome, Motorcraft, push-on*
 C3AZ-6766-E



65-66: FoMoCo logo, chrome, push-on*
 CSZZ-6766-D



65-67: FoMoCo logo, Shelby, chrome, push-on*
 CSZZ-6766-E



65-70: FoMoCo logo, black w/ tube, push-on*
 CSZZ-6766-B



65-70: Chrome & decal, push-on*
 CSZZ-6766-F

Oil Cap



67-70: Black, closed, w/ Autolite Logo, twist-on
 C8AZ-6766-A



67-70: Chrome, closed, w/ Autolite logo, twist-on
 C8AZ-6766-B



68-70: Chrome, closed, w/out logo, twist-on
 C8AZ-6766-BR



71-73: Painted, twist on
 D1ZZ-6766-B

AFTERMARKET OIL CAP

Brightens the engine compartment and looks sharp. Fits aftermarket valve covers only.

Oil Cap, Aftermarket



64-73: Chrome, push on, no tube
 W84881B



64-73: Chrome, OIL letters
 W89181B



64-73: Chrome, push on w/ tube
 W89252B

OIL CAP PCV ELBOW



Precision machined to the factory specifications. Light gold anodize finish just like the original. Perfect for our C8AZ-6766-A or -B oil caps.

Oil Cap PCV Elbow

67-70 Concoars C8AZ-6767-A

OIL CAP ADAPTER



This adapter allows slip-on type oil caps to be used on valve covers with twist-on type oil cap hole.

Oil Cap Adapter

64-73 C5AZ-6A868-A

WE PROUDLY FEATURE AUTHENTIC MUSTANG REPRODUCTIONS FROM SCOTT DRAKE ENTERPRISES!



OIL CAP TO AIR CLEANER HOSE



Correct hose to connect the oil cap breather to the air cleaner.

Features oval FoMoCo logo. Cut to fit.
Oil Cap To Air Cleaner Hose
 65-66 Cut to fit *C4AE-6853-B

ENGINE OIL DIP STICK



Our dip sticks are exact reproductions. Don't confuse these with generic imported versions that are kind of close.

Oil Dip Stick, Engine
 64 SB w/ gen, light greyC30Z-6750-B
 64 SB w/ gen, chromeC30Z-6750-C
 65-67 Blue, OE style, 289C5AZ-6750-B
 65-67 stainless handle, OE style, 289
 C5AZ-6750-BC
 68-73 Blue, OE style, 289/302C5AZ-6750-A
 68-73 stainless handle, OE style, 289/302
 C5AZ-6750-AC

ENGINE OIL DIP STICK TUBE



Original design available painted or chrome. Perfect fit.

Oil Dip Stick Tube, Engine
 64 260, blackC20Z-6754-A
 64 260, chromeC20Z-6754-C
 65 289, blackC5AZ-6754-A
 65 289, chromeC5AZ-6754-C
 66-67 289, blueC6AZ-6754-A
 66-67 289 chromeC6AZ-6754-C
 67-70 390, 428 blueC70Z-6754-A
 67-70 390, 428 chromeC70Z-6754-C
 68-69 302 blueC8AZ-6754-A
 68-69 302 chromeC8AZ-6754-C
 69 351W blueC90Z-6754-A
 69 351W chromeC90Z-6754-C

ENGINE OIL DIP STICK WITH TUBE



Resembles the original. All chrome plated. Note: Due to different water pump designs, mounting bracket may

need to be modified. Not concours.
Oil Dip Stick With Tube, Engine
 64-73 ChromeC5ZZ-6750-K
 69-73 351W chromeC9ZZ-6750-K
 70-73 351 Clev. chromeDOZZ-6750-K

OIL DRAIN PLUG

Correct oil drain plug with nylon gasket. Either plain or magnetic.

Oil Drain Plug



64-73: Stock w/ gasket
 D1AZ-6730-A



64-73: Magnetic
 C5ZZ-6730-M

OIL FILTER

* We have concours oil filters available. A must for any show. All are silk-screened with multiple colors.

Oil Filter



64-70: Gold, 6000 mile*
 C1AZ-6731-6000



64-73: White/Red Autolite*
 C1AZ-6731-FL1F



64-73: Red Rotunda*
 C1AZ-6731-RIA



64-88: Motorcraft*
 FL-1A



64-88: Motorcraft, hi-po*
 FL-1HP

CHROME OIL FILTER COVER



Quality chrome finish. Slips on your standard oil filter. Secures by tightening allen bolt. Fits all standard oil filters.

Oil Filter Cover, Chrome

64-73C5ZZ-6731-C

OIL FILTER MAGNET



The RA series of FilterMag™ oil filter magnets can be used for both standard and high performance engines. Built for the demanding needs of racing and heavy

duty applications. Fits 2.90 inch to 5.50 inch diameter oil filters.

Oil Filter Magnet

64-73 RacingACC-365-R
 64-73 Light dutyACC-365-S

OIL PAN



Oil Pan

64-70 6 cyl, blackC4DZ-6675-B
 64-73 SB V8, blackC5ZZ-6675-A
 64-73 SB, blueC5ZZ-6675-B
 64-73 SB, chromeC5ZZ-6675-C
 64-73 SB, unpaintedC5ZZ-6675-R
 67-70 BB (except CJ), blueC7ZZ-6675-B
 67-70 390 GT - 428 CJ, concours correct w/ FoMoCo logo *C60Z-6675-A
 67-70 BB (except Cobra Jet), chromeC7ZZ-6675-C
 69-73 351W, blueC9ZZ-6675-B
 69-73 351W, chromeC9ZZ-6675-C
 70-73 351 Clev, chromeD0ZZ-6675-C
 71 429, chromeD1ZZ-6675-C

"CAL CUSTOM" OIL PAN



Scott Drake is proud to reintroduce the famous "Cal Custom" aluminum finned oil pan that was so popular throughout the 60's, 70's and 80's. It

has not been available for years, but it is back again and now even better than before! Not only do these pans look great fully polished with raised fins but they also offer the added benefit of reducing oil temperature to help your engine run cooler. We have even added a strong magnetic drain plug to help protect your engine from destructive metallic particles floating in your oil. These Oil Pans fit: 260, 289, and 302. Also available "Cal Custom" Aluminum Finned Valve Covers (C5ZZ-6A582-AF) and Air Cleaner (C5ZZ-9600-AFK)

Oil Pan, "Cal Custom"

64-73 260, 289, 302C5ZZ-6675-ALUM

"T" OIL PAN



High capacity aluminum oil pan for 351W Mustangs. Includes pick up tube. Not polished. Extra thick casting for durability.

Oil Pan, "T"

69-70 351WC9ZZ-6675-ALUM

OIL PAN BOLT KIT



Yes, judges do look under your car! Don't get points taken off because of the wrong bolt. These are concours correct.

Oil Pan Bolt Kit

64-73 SB & 6 cyl.OPB-CODE-484
 67-70 BBOPB-B8AE-340
 69-71 429OPB-C85E-486
 70-73 351 Clev.OPB-D00E-485

OIL PAN GASKET KIT



Quality gasket set made by FELPRO®.

Oil Pan Gasket Kit

64-73	6 cyl.	C3DZ-6781-AK
64-73	SB	C5ZZ-6781-K
67-70	BB	C7ZZ-6781-D
69	351W	C9ZZ-6781-W
70-73	351 Clev.	DOZZ-6781-C

OIL PRESSURE SENDER EXTENSION

A Beautiful reproduction by Scott Drake. Hex shaped extension. Made from machined metal and chrome or zinc plated.

Oil Pressure Sender Extension



64-73: 8 cyl., zinc
C2OZ-9B339-A



64-73: 8 cyl., chrome
C2OZ-9B339-C

OIL PUMP



These name brand oil pumps are made in the U.S.A. to insure performance and reliability.

Oil Pump

64-73	260, 289, 302	C5ZZ-6600-A
69	351W	C9ZZ-6600-A
70-73	351 Clev.	DOZZ-6600-A

SMOG COMPONENTS

EXHAUST AIR CHECK VALVE



Smog emissions check valve. Fits 6 cylinder and 8 cylinder. Good replacement part not an exact copy. Limited supply!

Exhaust Air Check Valve

66-71	C6OZ-9A487-A
-------	-------	--------------

SMOG DIVERTER VALVE



These are made by Carter, the original supplier to Ford. Not a reproduction but New Old Stock. No Ford part number stamped on

case.

Smog Diverter Valve

70-72	Boss 302 & Boss 429	C8TZ-9B289-AR
-------	---------------------	-------	---------------

SMOG FERRULE AND NUT



This is the nut and ferrule (one piece) that attaches the smog tube to the cylinder head on 66/67 Mustangs.

Smog Ferrule and Nut

66-67	C6AZ-9B471-A
-------	-------	--------------

SMOG PUMP FILTER



Brought to you by Scott Drake. New open cell foam.

Smog Pump Filter

66-67	C6AZ-9A496-A
-------	-------	--------------

SMOG TUBES



Sold as a pair, this tube runs from the air check valve to the cylinder head on 1967 and 1968 emission equipped Mustangs.

Smog Tubes

67-68	C7OZ-9B445
-------	-------	------------

UNDER-HOOD COSMETICS

ECONOMY ENGINE DRESS UP KIT



This is an economical way to dress up your Mustang small block engine or any small block Ford. Brightens

engine compartment for a cleaner look. These kits are pre-packaged, sorry no substitutions. Includes one C5ZZ-9600-W air cleaner with 289 HiPo decal, one pair W89248B valve covers, one W84881B oil cap, one W84889B oil cap grommet and one W89771B PCV grommet.

Engine Dress Up Kit, Economy

64-73	C5ZZ-6980
-------	-------	-----------

SHOW-QUALITY ENGINE DRESS UP KIT



Correct, original-style air cleaner with concurs correct valve covers. Includes concurs chrome oil

cap. PCV grommet not included, order part# C8AZ-6892.

Engine Dress Up Kit, Show-Quality

64-73	C5ZZ-6980-PRO
-------	-------	---------------

UNDER-HOOD STAINLESS TRIM



This kit will really dress up your engine compartment. High quality polished stainless steel panels and all attaching

hardware included. Complete with installation instructions.

Under-Hood Stainless Trim

64-66	ACC-UHT-65
67-68	ACC-UHT-67
69-70	ACC-UHT-69

VALVE COVERS & COMPONENTS

PCV FITTING



Exact detail. Gold dichromate finish.

PCV Fitting

67-70	BB	C7OZ-6A706-A
-------	----	-------	--------------

PCV HOSE



Concours correct w/ stamped FoMoCo script. Connects PCV valve to carb spacer plate.

PCV Hose

65-68	SB*	C6AZ-6A664-N
68-70	BB*	C8AZ-6A664-D
69-70	351W*	C9OZ-6A664-A
70-73	351 Clev.*	DOAZ-6A664-C

VALVE COVER GASKET



Valve cover gaskets, made by Fel-Pro

Valve Cover Gasket

64-73	SB, cork	C2OZ-6584-AC
64-73	6 cyl.	CODE-6584-BR
64-73	SB, rubber	C2OZ-6584-AR
67-70	BB, cork	C7ZZ-6584-DC
67-70	BB, rubber	C7ZZ-6584-DR
70-73	351 Clev., cork	DOZZ-6584-CC
70-73	351 Clev., rubber	DOZZ-6584-CR

WE PROUDLY FEATURE AUTHENTIC MUSTANG REPRODUCTIONS FROM SCOTT DRAKE ENTERPRISES!



VALVE COVER



* Quality valve covers with a variety of finishes and styles.

Valve Cover



64-65: SB, painted gold
C5ZZ-6A582-G



64-66: SB, chrome, economy, aftermarket
C5ZZ-6A582-C



64-67: 289 hi-po, chrome, concours
C5ZZ-6A582-C/D



64-73: 6 cyl., chrome, aftermarket
C4DZ-6A582-C



64-73: SB, alum. finned
C5ZZ-6A582-AF



65-68: SB, blue
C5ZZ-6A582-BL



66-70: 390, 428, Chrome, "Power by Ford", concours
C6OZ-6A582-C



67-70: BB, chrome, aftermarket
C7ZZ-6A582-C



68-70: OE SB, "Power By Ford", Blue
C8OZ-6A582-BL



68-70: OE SB, "Power By Ford", chrome
C8OZ-6A582-C



70-73: 351 Clev., chrome, aftermarket
D0ZZ-6A582-C

SCOTT DRAKE CLASSIC ALUMINUM VALVE COVERS



Made by Scott Drake, Classic Aluminum Valve Covers for small block Ford engines! These valve covers are die-cast from high-quality 383-3 aluminum alloy, & then given a durable powder-coated wrinkled finish or polished aluminum finish. They also feature a cadmium plated oil filler tube to help stop corrosion, an improved oil baffle design to accommodate high-lift cam shafts, & will work with most roller rockers. Spark plug wire brackets & PCV grommet included. Available in a variety of styles.



6A582-S



6A582-B



6A582-R



6A582-F

Note: "COBRA" (S2MS-6A582-A/B and S1MS-6A582-P) and "MUSTANG" (C5ZZ-6A582-A/B) versions are not made by Scott Drake, and will not clear roller rockers



	SKU	Fits	Description
289 POWERED BY FORD	6A582-289*	64-73	"289", Black
	6A582-289P*	64-73	"289", Polished
302 POWERED BY FORD	6A582-302*	64-73	"302", Black
	6A582-302P*	64-73	"302", Polished
351 POWERED BY FORD	6A582-351*	64-73	"351", Black
	6A582-351P*	64-73	"351", Polished
SHELBY	6A582-S ^s	64-73	"Shelby", Black
	6A582-SP ^s	64-73	"Shelby", Polished
Bronco POWERED BY FORD	6A582-B*	64-73	"Bronco", Black
	6A582-BP*	64-73	"Bronco", Polished
Rancho POWERED BY FORD	6A582-R*	64-73	"Rancho", Black
	6A582-RP*	64-73	"Rancho", Polished
Falcon POWERED BY FORD	6A582-F*	64-73	"Falcon", Black
	6A582-FP*	64-73	"Falcon", Polished
Street Rod POWERED BY FORD	6A582-SR*	64-73	"Street Rod", Black
	6A582-SRP*	64-73	"Street Rod", Polished
Fairlane POWERED BY FORD	6A582-FL*	64-73	"Fairlane", Black
	6A582-FLP*	64-73	"Fairlane", Polished
Comet POWERED BY FORD	6A582-CT	64-73	"Comet", Black
	6A582-CTP*	64-73	"Comet", Polished
MUSTANG POWERED BY FORD	C5ZZ-6A582-A/B*	64-73	"Mustang", Black <i>Polished aluminum version not currently available in this style</i>
	S2MS-6A582-A/B*	64-73	"Cobra", Black <i>Polished aluminum version not currently available in this style</i>
COBRA POWERED BY FORD	S1MS-6A582-P*	65	"Cobra (open letters)", Natural w/ polished fins
	6A582-CO*	64-73	"Cougar", Black
COUGAR	6A582-COP*	64-73	"Cougar", Polished



S2MS-6A582-A/B





VALVE COVER GROMMET

Valve Cover Grommet



- 64-68: For OEM stamped steel valve covers*
C8AZ-6892
- 64-73: Ford Motor Sport
C5Z-6A892-FMS
- 64-73: Oil cap, 1" inside dia., work on our chrome aftermarket valve covers
W84889B
- 64-73: Oil cap, 3/4" inside dia., work on our chrome aftermarket valve covers
W89771B
- 65-67: 1" opening, alum. valve covers
C5Z-6A892-A
- 65-73: Round w/ notches
C7AZ-6892
- 67-69: orig. factory specs, perfect fit for C80Z-6A582-C
C6AZ-6892-A
- 70-71: For OEM stamped steel valve covers
D00Z-6892

EXHAUST SYSTEM

EXHAUST HEADERS

HI-PERFORMANCE 6 CYL. EXHAUST HEADERS

We believe that a properly modified 6 cyl. will put out as much usable low RPM horsepower as a V8. We offer both the single and dual outlet versions. Single outlet is recommended if no other modifications will be made. Dual outlets work best with Hi-Po Camshaft, 2V carb and Pertronix Ignitor. Single outlet also works well with these modifications. Dual outlet is for customers that want the look and sound of a V8. We recommend buying an exhaust port divider (part # C3OZ-9430-EPD) which smooths out air flow between the #3 and #4 cylinder. Will fit Mustangs, Falcons, Rancheros, Comets, Fairlanes, Torinos, and Mavericks. See "Engine" category for Hi-Po Camshaft.

Exhaust Headers, Hi-Performance 6 Cyl.



64-69: Dual outlet, nickel plated, fits 170, 200, 250
C3OZ-9430-H2



64-73: Single outlet, nickel plated, fits 170, 200, 250
C3OZ-9430-H1

JBA BIG BLOCK, TRI-Y EXHAUST HEADERS



JBA's Tri-Y long tube headers for 390/428 give you the power you're looking for in a package that fits like no other. JBA's designs

are application specific to best fit the engine/transmission combination in your Mustang. They also feature big 1-3/4" primaries that flow in to 2-1/4" secondary tubes and terminate in a big 3" collector. Plus they are designed to give maximum ground clearance for street or track use. With heavy-duty stainless steel tubing, thick 3/8" laser-cut flanges and JBA sealing dome collector, you don't have to worry about leaks caused by lesser materials. *Note for JBA-6656-S: 69-70 cars with factory reinforced shock tower may have minor clearance issues. If you are running standard 390 heads versus 390GT heads we can special order you correct headers for the same price.

Exhaust Headers, JBA Big Block, Tri-Y

- 70-71: Tri-Y, 390-GT, will not fit std. heads JBA-6656-S
- 69-70: Tri-Y, 428CJ, will clear reinforced towers . JBA-6655-S1

JBA SHORTY EXHAUST HEADERS



Custom built premium quality headers. Compare these features to the competition. Precision laser cut

3/8 inch flanges, Mandrel bent 14 gauge tubes, Patented fire cone which optimizes scavenging, lifetime warranty by maker, sealing dome technology, industrial nickel plating, installation instructions, gaskets and mounting hardware. We feel these are the best headers on the market. Note: 64-65 Mustangs will require 1966-1970 motor mounts and brackets for proper clearance (see "Engine" category)

Exhaust Headers, JBA Shorty

- 64-70: Shorty, 289 & 302 JBA-1650
- 64-73: Shorty, 289 & 302, ceramic coated JBA-1650-C
- 64-73: Shorty, 351W JBA-1653-1

SHORTY EXHAUST HEADERS



Note: 64-65 Mustangs will require 1966-1970 motor mounts and brackets for proper clearance (see "Engine" category)

Exhaust Headers, Shorty

- 64-70: 15/8" shorty C5Z-9430-SH

TRI-Y EXHAUST HEADERS



These feature extra thick flanges, miter cut 16 gauge tubes & are precision Mig welded to ensure a proper

fit & eliminate exhaust leaks. Comes boxed complete with premium gaskets, all necessary mounting hardware & reducer cones.

Exhaust Headers, Tri-Y

- 64-68: SB, black-non high temp S1MS-9430-BL
- 64-68: SB, nickel plated S1MS-9430-CR
- 64-68: SB, unpainted S1MS-9430-RAW

MANIFOLD AND COMPONENTS

EXHAUST MANIFOLD



These manifolds are cast from high quality molds for proper fit and appearance. Includes exhaust flange bolts, nuts and

washers.

Exhaust Manifold

- 64-67: 6 cyl. C3OZ-9430-AR
- 64-73: SB, hi-po C5Z-9430/1-B
- 64-73: SB C5Z-9430/1-DE
- 68-70: Cobra Jet 428 C8OZ-9430/1-BC
- 68-73: 6 cyl. w/ IMCO D3BZ-9430-A
- 68-73: 6 cyl. w/out IMCO D3BZ-9430-B

EXHAUST MANIFOLD BOLT KIT



Exact copies made from the original supplier to Ford Motor Co. U.S.A. made. Ramp-Lok features a special conical washer

designed specifically for exhaust manifolds.

Exhaust Manifold Bolt Kit

- 64-65: 6 cyl. EMB-CODE-554
- 64-65: SB EMB-C20E-555
- 64-65: 289 hi-po EMB-C30E-556
- 66-67: 200 6 cyl. EMB-C60E-525
- 66-67: 289 EMB-C60E-527
- 66-67: 289 hi-po EMB-C6ZE-528
- 67-68: 390 GT & GT500 EMB-C70E-539
- 68-69: 390 GT, late 1968 EMB-C80E-540
- 68-69: 428 Cobra Jet EMB-C80E-542
- 68-73: 200, 250 6 cyl. EMB-C8DE-526
- 68-73: SB EMB-C80E-529
- 69: 302, 351W EMB-C90E-530
- 69-70: Boss 429 EMB-C9AE-543
- 69-70: Boss 302 EMB-C9ZE-531
- 70-71: 351 Clev. 2 Barrel EMB-D00E-533
- 70-71: 351 Clev. 4 Barrel EMB-D00E-534
- 71: 429 Cobra Jet EMB-D00E-544
- 72-73: 351 Clev. 2 Barrel EMB-D20E-535
- 72-73: 351 Clev. 4 Barrel EMB-D20E-536

WE PROUDLY FEATURE AUTHENTIC MUSTANG REPRODUCTIONS FROM SCOTT DRAKE ENTERPRISES!



EXHAUST MANIFOLD GASKET



Gasket between the cylinder head and the exhaust manifold.

Exhaust Manifold Gasket

- 64-68 6 cyl. C3DZ-9433-A
- 70-73 351 Clev. 2 Barrel D0ZZ-9433-A
- 70-73 351 Clev. 4 Barrel D0ZZ-9433-B

EXHAUST MANIFOLD GASKET KIT



Includes exhaust manifold gaskets, pipe flange gaskets and exhaust manifold to pipe gaskets

Exhaust Manifold Gasket Kit

- 64-73 SB C5ZZ-9433-A/B

EXHAUST MANIFOLD HEAT RISER



Breather tube which attaches to air cleaner and mounts to the R.H. exhaust manifold.

Exhaust Manifold Heat Riser

- 65-67 289 C5ZZ-9A603-B
- 68-72 289, 302 C8ZZ-9A603-A

EXHAUST MANIFOLD HEAT RISER STUD



Exhaust Manifold Heat Riser Stud

- 64-68 379763-S

EXHAUST MANIFOLD LOCKING TAB



Features zinc plating and the correct annealing for crack-free bends. Locks manifold bolts in place, prevents them from turning.

Exhaust Manifold Locking Tab

- 64-66 260, 289 C20Z-9A447-A

EXHAUST PIPE FLANGE GASKET



Donut shaped gasket between the manifold and the down pipe.

Exhaust Pipe Flange Gasket

- 64-68 6 cyl. C30Z-9450-A
- 64-73 SB & 6 cyl. C30Z-9450-B
- 67-70 390 C9ZZ-9450-D
- 69-73 351W & 351 Clev. C9ZZ-9450-A

EXHAUST PORT DIVIDER



Smooths out air flow between #3 and #4 exhaust ports. Can be used with standard exhaust manifold and headers.

Exhaust Port Divider

- 64-73 170, 200, 250 C30Z-9430-EPD

FACTORY START TUBES



These starter tubes are specially designed to bolt to shorty headers to ease installation. Requires welding of

exhaust system to these tubes. Connects headers to exhaust system.

Factory Start Tubes

- 64-70 w/ carb. connection JBA-1650ST
- 64-70 w/ O2 sensor connection . JBA-1650ST-1

PIPES, CLAMPS & BRACKETS

REAR UPPER EXHAUST BRACKET



Exhaust Bracket, Rear Upper

- 65-70 LH, GT C5ZZ-5277-A
- 65-70 RH, GT C5ZZ-5277-B

EXHAUST HANGER

A variety of hangers to keep exhaust systems at stock positions.

Exhaust Hanger



- 65-66: RH or LH, Dual exhaust
C5ZZ-5A246-D



- 65-68: LH, single exhaust
C5ZZ-5A246-A



- 65-68: RH, single exhaust
C5ZZ-5A246-B



- 65-69: Rear, dual exhaust
C6ZZ-5266-AR



- 70-73: RH, Dual exhaust
D0ZZ-5260-A
- 70-73: LH, Dual exhaust
D0ZZ-5260-B

EXHAUST HANGER INSULATOR



This insulator does just that, it secures the pipe to the hanger and absorbs vibration.

The rubber pad keeps it from rattling against the undercarriage. For 1965 through 1969 Mustangs with V8 engines and dual factory exhaust. You need two of these.

Exhaust Hanger Insulator

- 65-70 C5ZZ-5260-B

EXHAUST HANGER RETAINER



Used on dual exhausts cars this mounts to floor under rear seat. Attaches exhaust

muffler hanger to floor. Includes hardware. Not exact copy of original.

Exhaust Hanger Retainer

- 65-70 Dual exhaust C5ZZ-5A247-A

DUAL EXHAUST KIT



Original replacement, dual exhaust system for 1964-66 260 and 289. **Can also be adapted for 1967-68 289 and 302 engines.** This

kit consists of the "H" pipe, the intermediate pipes, mufflers and exhaust tail pipes made from 2" aluminized steel tubing. All clamps and hangers are sold separately.

Exhaust Kit, Dual

- 64-68 Complete system use w/standard manifolds w/out resonators, (no clamps or hangers) C5ZZ-5246/30-K
- 64-68 Complete system use w/standard manifolds w/ resonators, (no clamps or hangers) C5ZZ-5246/30-KR
- 64-68 Complete system use w/HiPo manifolds w/out resonators, (no clamps or hangers) C5ZZ-5246/30-HP
- 64-68 Complete system use w/HiPo manifolds w/ resonators, (no clamps or hangers) C5ZZ-5246/30HPR

"H" EXHAUST PIPE



Precision mandrel formed bends for smoother flowing exhaust. Fits 260, 289 and 302.

Exhaust Pipe, "H"

- 64-68 SB, dual, std. manifolds C5ZZ-5246-J
- 64-66 SB, dual, Hi-Po manifolds .. C5ZZ-5246-K

EXHAUST PIPE CLAMP

Pipe clamps in both original & replacement styles.
Exhaust Pipe Clamp



65-68: Replacement type
C6ZZ-5A231-AR



65-69: orig. (horse shoe) style
CSZZ-5A231-A

EXHAUST TIPS

We stock these exhaust tips to finish off the rear valance.

Exhaust Tips



65-66: GT, concours, show quality
CSZZ-5255-PRO



65-66: GT, 2" pipe, high-flow design
CSZZ-5255-GT2



65-66: GT, reproduction, economy
CSZZ-5255-C/D



67-69: orig. style, dual exhaust
C7ZZ-5258-C



70: Mach 1, concours w/ correct
rolled tip
D0ZZ-5255-A



67-70: Mach 1, reproduction
D0ZZ-5255-AR



71-73
D1ZZ-5225-G



67: Eleanor, cast alum., side exhaust
S7MS-5255-E

EXHAUST TRIM REAR VALANCE



Beautiful addition to the rear valance, finishes off the cut out for the exhaust pipe.

Exhaust Trim Rear Valance

65-66CSZZ-5C299-A

6 CYL. HEAD PIPE HANGER BRACKET



Head Pipe Hanger Bracket, 6 Cyl.

64-67 6 cyl., singleC4DZ-5291-A

MUFFLER



Features fully aluminized double wall construction, exact OEM dimensions and proper attaching brackets when

required. Easy to install. C7ZZ & D0ZZ do not have attaching bracket.

Muffler

64-66 8 cyl., single exhaust C5ZZ-5230-D

64-66 6 cyl.CSZZ-5230-T

67 SB, single exhaust C7ZZ-5230-A

67 6 cyl.C7ZZ-5230-D

68-70 6 cyl. 200 C8ZZ-5230-A

68-70 SB, single exhaust C8ZZ-5230-B

69 Transverse Dual exhaustC9ZZ-5230-C

70 Dual exhaust, 302, 351 ..D0ZZ-5230-B/D

FUEL SYSTEM

ACCELERATOR COMPONENTS

ACCELERATOR CABLE



Cable link between the accelerator pedal and the linkage to the carburetor.

Accelerator Cable

69 302, 351, 390, & 428 C9ZZ-9A758-A

70 302, 351 & 428C9ZZ-9A758-E

ACCELERATOR LINKAGE KIT

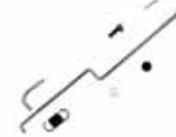

Kit comes complete with accelerator linkage rod, bushings and clip kit, return spring, and bracket.

Accelerator Linkage Kit

64-67 289 2 BarrelCSZZ-9A702-2K

64-67 289 4 BarrelCSZZ-9A702-4K

ACCELERATOR LINKAGE ROD



Rod which connects carb to main linkage. Silver zinc plated. Also available in chrome.

Accelerator Linkage Rod

64-67 ChromeCSZZ-9A702-C

65-67 Silver CSZZ-9A702-D

ACCELERATOR LINKAGE ROD BUSHING KIT



All the necessary hardware needed for a trouble free installation. Includes rubber

insulator bushing, nylon insert bushing, cotter key, washer and carb to linkage clip.

Accelerator Linkage Rod Bushing Kit

64-67CSZZ-9A702-MK

ACCELERATOR MOUNTING SCREW



A precision machined screw with exact detail. Painted black. Made by Scott Drake.

Accelerator Mounting Screw

64-68380503-5101

ACCELERATOR PEDAL



These steel reinforced parts are molded from high quality rubber for a long life and great appearance.

Accelerator Pedal

64-68 w/ stainless trim C5ZZ-9735-D

69-70 w/out trim C9ZZ-9735-D

71-73 w/out trim D1ZZ-9735

ACCELERATOR PEDAL ASSEMBLY



Replace your misaligned pedal with a new safer unit.

Accelerator Pedal Assembly

69 C9ZZ-9735-K

WE PROUDLY FEATURE AUTHENTIC MUSTANG REPRODUCTIONS FROM SCOTT DRAKE ENTERPRISES!



ACCELERATOR PEDAL SPRING



Made of strong spring steel for a long life. Made by Drake.

Accelerator Pedal Spring
64-68 Spring steel C5Z-9760-B

ACCELERATOR RETURN SPRING



Correct spring, black phosphorus plated.

Accelerator Return Spring
64-68 C5Z-9737-B

ACCELERATOR ROD GROMMET



This is the small rubber grommet that attaches where the accelerator rod meets the linkage rod to ensure a smooth pivot without sticking.

Accelerator Rod Grommet
64-69 379009-S

KICK DOWN CABLE



Kick Down Cable - 10.2" long. Fits 6 cylinder and V8.

Kick Down Cable
66-68 C60Z-7A187-D

PEDAL PIVOT ASSEMBLY

Better quality and fit. Painted detail gray. New lower price. New Lower Price!
Pedal Pivot Assembly



64-65: 260, 289 All ;
66-68: 289, 302 Manual
C5Z-9725-A



66-68: 289, 302 Automatic
C6Z-9725-B

RETURN SPRING BRACKET



Neat detail item, stamped steel with zinc plating.

Return Spring Bracket
64-65 Bell crank C5Z-9741-K
64-66 4 Barrel C5Z-9741-C
64-68 2 Barrel C3AZ-9741-A
65-66 2 Barrel C5Z-9741-A

CARBURETOR COMPONENTS

CARBURETOR ADAPTER



These carburetor adapters can adapt either a Holley 2V or Weber 2V carb. to your stock 1-V intake. This will enhance other upgrades such as headers and camshafts. Bottom holes are not drilled.

Carburetor Adapter
64-68 Holley 2 barrel C30Z-9A589-SM
64-68 Weber 2 barrel C30Z-9A589-SM-W
69-73 Holley 2 barrel 1 3/4" C90Z-9A589-LG
69-73 Weber 2 barrel 1 3/4" C90Z-9A589-LG-W

CARBURETOR SPACER

A nice reproduction of a part that is commonly in need of replacement.

Carburetor Spacer



64-68: 6 cyl.
C3UZ-9A589-B



65-68: 289 4 barrel
C30Z-9A589-C

CARBURETOR SPACER GASKET



The gasket that goes between the spacer and the manifold and between the manifold and carburetor.

Carburetor Spacer Gasket

64-66 4 Barrel C2AZ-9447-E
64-73 2 Barrel C3AZ-9447-B
64-73 6 cyl. C3DZ-9447-A
67-70 4 Barrel C7ZZ-9447-A
67-70 2 Barrel C7ZZ-9447-D2
67-70 4 Barrel C7ZZ-9447-D3
67-70 4 Barrel C7ZZ-9447-D4
70-73 2 Barrel D0ZZ-9447-C2
70-73 4 Barrel D0ZZ-9447-C4

CHOKE/HEAT RISER AND RELATED

CHOKE CABLE



This is the exact replacement for the manual choke cable. Mounting hardware is included. Originally built for High Performance 289.

Choke Cable
65-66 C5Z-9700-AR

CHOKE THERMOSTAT SHIELD



This stamped steel part bolts to carburetor and holds heater hose against choke.

Choke Thermostat Shield
65-69 C5ZZ-9861

CHOKE TUBE KIT



We have these steel tubes made for us to exacting O.E.M. standards and specifications. All choke tubes have the

proper fiberglass insulation, fittings, rubber hose, and S-clip. Also includes cold air tube when applicable. A part# ending in "S" denotes stainless steel.

Choke Tube Kit

64-69 64-69: 170, 200 MCT003
64-69 64-69: 170, 200 Stainless MCT003S
70 70: 200 MCT004
70 70: 200 Stainless MCT004S
64-73 64-73: 260, 289, 302, 2 BBL.
64-66: 260, 289-2 or 4 BBL.
69: 351W-2BBL MCT001
64-73 64-73: 260, 289, 302, 2 BBL.
64-66: 260, 289-2 or 4 BBL.
69: 351W-2BBL
Stainless MCT001S
67-68 67: "A" code, 289, 4 BBL.
68: "J" code, 302, 4 BBL. MCT008
67-68 67: "A" code, 289, 4 BBL.
68: "J" code, 302, 4 BBL.
Stainless MCT008S
67-68 67-68: 390, BB MCT002
67-68 67-68: 390, BB Stainless MCT002S
67 67: 428, dual 4 BBL., Shelby only MCT007
67 67: 428, dual 4 BBL., Shelby only Stainless
MCT007S
68-69 68-69: 428 CJ MCT009
68-69 68-69: 428 CJ Stainless MCT009S
69-70 69: 351W, 4 BBL.
70: 351, 4 BBL., Shelby MCT005
69-70 69: 351W, 4 BBL.
70: 351, 4 BBL., Shelby
Stainless MCT005S
69 69: 351W, 2 barrel MCT013
70-73 70-73: 2 BBL., 4 BBL. MCT011
70-73 70-73: 2 BBL., 4 BBL.
Stainless MCT011S
64-73 64-73: Universal kit for headers MCT014

FUEL FILTERS, PUMPS, & SENDING UNITS

FUEL FILTER

Filters protect your carburetor from costly repairs by trapping dirt. For original carburetor's only. Please confirm thread size you need.

Fuel Filter



64-65: Element
C4AZ-9365-B



64-73: 5/16"
W89258B



64-73: 3/8"
W89418B



65-73: In line
C2RZ-9155-A



66-67: 8 cyl.
C5AZ-9155-B



66-73: 6 cyl.
D3AZ-9155-C
66-73: BB
D30Z-9155-B

SENDING UNIT FUEL FILTER



Replaceable filters which attaches to original fuel sending unit.

Fuel Filter, Sending Unit

64-73 3/8"D1AZ-9A011-A
64-73 5/16"D1FZ-9A011-A

FUEL HOSE



Quality U.S.A. made hose with concourse repeating GAS markings. Also include OEM mounting hardware.

Fuel Hose

64-68 5/16" C5ZZ-9327-A
67-73 3/8" C7ZZ-9327-A

FUEL PUMP MOUNTING GASKET



Always replace this gasket when replacing the fuel pump. Made in the U.S.A.

Fuel Pump Mounting Gasket

64-73 C3AZ-9417-C

FUEL PUMP



These original style diaphragm pumps are all-new, not rebuilt. Includes mounting gasket. Not concours.

Fuel Pump

64-65 170, 200 & 240 engines C3AZ-9350-Y
64-65 Early 260 & 289 C5OZ-9350-A
66-67 289 C5AZ-9350-B
66-67 200 6 cyl. C5UZ-9350-C
67 390 C6AZ-9350-B
68-69 390 D8TZ-9350-C
68-70 428 engine C7AZ-9350-A
68-73 200 & 250 6 cyl. D3TZ-9350-A
70-73 351 Clev. D7SZ-9350-C

FUEL PUMP FILTER CANISTER

* Concourse correct, and quality reproduction with silk-screened logo and authentic markings.

Fuel Pump Filter Canister



64-65: Red*
C3AZ-9355-R

FUEL PUMP REBUILD KIT



Use this kit to rebuild your original Carter fuel pump on your Boss 302, Boss 429, 428PI, 428CJ or 429 SCJ. This kit will work only on pumps

with a screw together body.

Fuel Pump Rebuild Kit

67-73 C7AZ-9349-A

FUEL TANK SENDING UNIT



Complete sending unit with plastic float on a steel arm. New gasket included. Does not include retaining ring.

Scott Drakes commitment to service includes inspecting and performing a OHMS test on 100% of our sending units to help assure a trouble free installation.

Sending Unit, Fuel Tank

64-67 Zinc, 5/16" tube C5ZZ-9275-CR
64-68 Zinc 3/8" tube C8ZZ-9275-CR
69 Zinc C9ZZ-9275-C
70 Zinc D0ZZ-9275-C
71-73 Zinc D1ZZ-9275-C

STAINLESS STEEL FUEL TANK SENDING UNIT

All the features of the above sending units, plus these units feature quality stainless steel construction and a brass float instead of plastic.

Sending Unit, Fuel Tank

64-67 stainless, 5/16" tube C5ZZ-9275-C
64-68 stainless 3/8" tube C8ZZ-9275-C

SENDING UNIT FLOAT



Correct brass float with original style construction. Lasts longer than cheap plastic floats available

on many imported fuel senders. Floats commonly leak causing fuel gauge failure.

Sending Unit Float

64-73 Brass C0AZ-9202-B

SENDING UNIT GASKET



Sending Unit Gasket

64-73 C0AF-9276-A

SENDING UNIT RETAINING RING



Our reproduction ring features original fit and the same heavy duty steel construction as the original.

Sending Unit Retaining Ring

64-73 C0AZ-9A307-B

FUEL LINES

BRAKE AND FUEL LINE CLIP KIT



Convenient kit which mounts front to rear gas lines and long brake line. Kit includes all clips, fasteners and instructions.

Brake And Fuel Line Clip Kit

64-67 380374-MK

FUEL LINE BRACKET



Mounts to the drivers side of the water pump to secure fuel line on its path to the carburetor.

Fuel Line Bracket

64-65 Zinc C5ZZ-9D319
66 Plain C6ZZ-9D319

FUEL LINE GROMMET



This is the grommet that protects the fuel line as it passes through the driver's side inner fender panel.

Fuel Line Grommet

71-73 3/8" D1ZZ-9288

WE PROUDLY FEATURE AUTHENTIC MUSTANG REPRODUCTIONS FROM SCOTT DRAKE ENTERPRISES!



FUEL TRANSFER LINE



This line transfers fuel from the front fuel bowl to the rear fuel bowl on Holley carburetors.

Fuel Transfer Line

- 64-67 715 HolleyMGL012
- 64-67 715 Holley, stainlessMGL012S

TANK TO PUMP FUEL LINE



Features corrosion resistant lines with the correct fittings. Because of their long length, all lines are gently bent so they are

U.P.S. shippable. These are easily straightened upon receipt.

Fuel Line, Tank To Pump

- 64-66 6 cyl., 5/16, 1 pieceMLG004
- 67 6 cyl., 5/16, 1 piece, stainless ..MLG004S
- 67 6 cyl., 5/16, 2 pieceMLG007
- 67 6 cyl., 5/16, 2 piece, stainless ..MLG007S
- 68-70 6 cyl., 3/8, 2 pieceMLG008
- 68-70 6 cyl., 3/8, 2 piece, stainless ...MLG008S
- 71-73 6 cyl., 5/16, 1 pieceMLG010
- 71-73 6 cyl., 5/16, 1 piece, stainless ..MLG010S
- 64-67 8 cyl., 5/16, 1 pieceMLG002
- 64-67 8 cyl., 5/16, 1 piece stainless ...MLG002S
- 65-66 Larger (3/8") for hi-po cars (Shelby)MLG012
- 67 8 cyl., 5/16, 2 pieceMLG003
- 67 8 cyl., 5/16, 2 piece, stainless ..MLG003S
- 68-70 8 cyl., 3/8, 2 piece Except cars w/ staggered shocksMLG009
- 68-70 8 cyl., 3/8, 2 piece, stainless, except cars w/ staggered shocksMLG009S
- 68-70 8 cyl., 3/8, 2 piece, w/ staggered shocks, including Boss302 & Boss 429 ..MLG001
- 68-70 8 cyl., 3/8, 2 piece, w/ staggered shocks, including Boss 302 & Boss 429, stainlessMLG001S
- 69-70 8 cyl., 3/8, 2 piece, w/ rear sway barMLG005
- 69-70 8 cyl., 3/8, 2 piece, w/ rear sway bar, stainlessMLG005S
- 71-73 8 cyl., 3/8, 2 pieceMLG006
- 71-73 8 cyl., 3/8, 2 piece, stainlessMLG006S
- 71-73 8 cyl., 5/16, 1 piece, w/ vapor return lineMLG011
- 71-73 8 cyl., 5/16, 1 piece, w/ vapor return line, stainless.MLG011S

PUMP TO CARBURETOR FUEL LINE



These reproduction fuel lines are exact duplicates of the originals, and feature all the correct fittings.

Available in original steel or corrosion resistant stainless steel.

Fuel Line, Pump To Carburetor

- 64-65 170MGL006
- 64-65 170, stainlessMGL006S
- 66-67 200MGL004
- 66-67 200, stainlessMGL004S
- 68-70 200MGL017
- 68-70 200, stainlessMGL017S
- 64 260MGL003
- 64 260, stainlessMGL003S
- 65 289MGL001
- 65 289, stainlessMGL001S
- 66-67 289MGL002
- 66-67 289, stainlessMGL002S
- 64-65 289 w/ HolleyMGL011
- 64-65 289 w/ Holley, stainlessMGL011S
- 66-67 289 w/ Holley 715MGL021
- 66-67 289 w/ Holley 715, stainless ...MGL021S
- 67-70 390, 428 police interceptorMGL007
- 67-70 390, 428 police interceptor, stainlessMGL007S
- 67 390 2 barrelMGL014
- 67 390 2 barrel, stainlessMGL014S
- 67 390 4 barrelMGL015
- 67 390 4 barrel, stainlessMGL015S
- 67 428 8 barrelMGL020
- 67 428 8 barrel, stainlessMGL020S
- 68 302 4 barrelMGL022
- 68 302 4 barrel, stainlessMGL022S
- 68-70 289, 302 2 barrelMGL005
- 68-70 289, 302 2 barrel, stainlessMGL005S
- 69 351, 4 barrelMGL009
- 69 351, 4 barrel, stainlessMGL009S
- 69-70 Boss 302MGL010
- 69-70 Boss 302, stainlessMGL010S
- 69-70 Boss 429MGL008
- 69-70 Boss 429, stainlessMGL008S
- 70-73 351 Clev. 2 barrelMGL016
- 70-73 351 Clev. 2 barrel, stainlessMGL016S
- 70-73 351 4 barrelMGL013
- 70-73 351 4 barrel, stainlessMGL013S
- 70-73 429 Cobra JetMGL018
- 70-73 429 Cobra Jet, stainlessMGL018S
- 70-73 429 Super Cobra JetMGL019
- 70-73 429 Super Cobra Jet, stainless .MGL019S
- 71 302 2 bbl., stainlessMGL024S
- 71 302 2 bbl.MGL024
- 71 Boss 351 Clev., stainlessMGL023S
- 71 Boss 351 Clev.MGL023

FUEL TANKS & COMPONENTS

FUEL FILLER TUBE



Fuel inlet filler tube. Perfect copy of the original. Plated to stop corrosion.

Filler Tube, Fuel

- 64-66C5ZZ-9034-B
- 67-68C7ZZ-9034-A
- 69C9ZZ-9034-A
- 70 w/out California emissions D0ZZ-9034-A

FUEL FILLER FLANGE GASKET

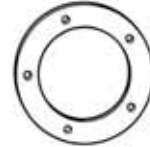

These reproduction seals are made from fuel resistant cork and are perfect replacements for restorations or service.

Will prevent fuel spills or water from entering the trunk area via the filler tube flange.

Fuel Filler Flange Gasket

- 64-71C5ZZ-9076-A

FUEL FILLER HOSE



American made fuel resistant rubber. Perfect fit. Available with red stripes and Autolite logo.

Fuel Filler Hose

- 64-67 4", all blackC4GY-9047-A
- 64-67 w/ logoC4GY-9047-AL
- 65-70 6", all black, w/out California emissions ..C8ZA-9047
- 68-70 w/ logo, w/out California emissionsC8ZA-9047-AL

FUEL FILLER PIPE TO TRUNK FLOOR SEAL



Fuel Filler Pipe To Trunk Floor Seal

- 71-73D1ZZ-9008

FUEL PIPE HOSE CLAMP



Original style wire clamps for retaining the filler hose to the tank standpipe and filler neck.

Fuel Pipe Hose Clamp

- 64-70C5ZZ-8287

FUEL TANK

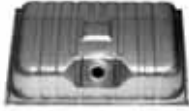

These hand crafted American gas tanks use industry standard Ni-Terne steel. This high liability part is backed by a company

known for leading the industry in safety and craftsmanship. Seam welded and pressure tested under water twice for integrity. Each tank has a 3 year warranty by the manufacturer. New retaining ring and gasket included.

Fuel Tank

64-68	w/ drain plugC5ZZ-9002-D1A
64-68	w/out drain plugC5ZZ-9002-D2A
69	20 gallon capacityC9ZZ-9002-A
70	22 gallon capacity, w/out California emissionsD0ZZ-9002-A
71-73	D1ZZ-9002

STAINLESS STEEL FUEL TANK

Fuel Tank, Stainless Steel

64-68	w/ drainC5ZZ-9002-SS
69	w/ drainC9ZZ-9002-SS
70	w/ drainD0ZZ-9002-SS

FUEL TANK FILLER KIT



This useful kit is easy and convenient.

Fuel Tank Filler Kit

64-67KIT-FUL-1
-------	----------------

FUEL TANK FILLER MOUNT SCREW



Special sheet metal screws used to attach filler tube to tail lamp panel. Cadmium

plated. Screw on fuel caps only, not for pop open type.

Fuel Tank Filler Mount Screw

64-68	Set of 542120-SK
-------	----------	---------------

FUEL TANK MOUNTING KIT



Includes eleven cadmium plated sheet metal screws, one black oxide captive washer

bolt, and one "J" plate nut.

Fuel Tank Mounting Kit

64-68C5ZZ-9002-MK
-------	-------------------

GAS CAPS

GAS CAP

* Made by Scott Drake, authentic Concours Mustang Gas Caps! Made in the U.S.A., these gas caps are the best on the market, far superior to import reproductions. These caps also feature a security cable on back to prevent theft. Officially licensed by Ford.

Gas Cap



64: No cable*
C5ZZ-9030-A



65: w/ cable*
C5ZZ-9030-B



65: T5*
C5ZZ-9030-C



66: GT*
C6ZZ-9030-A



66: std.*
C6ZZ-9030-B



66: Shelby GT-350*
S2MS-9030-A



67: std.*
C7ZZ-9030-A



67: GT pop open
C7ZZ-9030-B



67: GT Twist on
C7ZZ-9030-C



67: dlx. pop open*
C7ZZ-9030-D

Gas Cap



68: std. twist on*
C8ZZ-9030-A



68: dlx. pop open*
C8ZZ-9030-C



68: GT pop open
C8ZZ-9030-D



69: std. twist on*
C9ZZ-9030-A



69: dlx. pop open*
C9ZZ-9030-C



70: Non vented*
D0ZZ-9030-D



70: dlx. pop open*
D0ZZ-9030-E



71-73: Vented, no cable*
D1ZZ-9030-A



71-73: Vented w/ cable*
D1ZZ-9030-B



71-73: Mach 1
D1ZZ-9030-C

GAS CAP RELOCATION KIT



This kit is used to relocate the gas cap to the driver's side "B" pillar as typically seen on Eleanor Mustangs. Kit

includes everything needed for an authentic conversion.

Gas Cap Relocation Kit

67-68S7MS-9030/9034K
-------	----------------------

WE PROUDLY FEATURE AUTHENTIC MUSTANG REPRODUCTIONS FROM SCOTT DRAKE ENTERPRISES!



ALUMINUM BILLET GAS CAP



The perfect finishing touch for your "Resto-Mod". Machined from a solid block of billet aluminum. Features our black button head screws and our quality internal components. Security cable included to deter theft. Available with several types of emblems and also in black anodized. Will not fit 1970 cars with California emissions.

Gas Cap, Aluminum Billet



64-73: Cobra emblem*
B-9030-COBRA



64-73: GT emblem
B-9030-GT



64-73: Horse emblem*
B-9030-H



64-73: Plain
B-9030-P

BLACK ALUMINUM BILLET GAS CAP



The perfect finishing touch for your "Resto-Mod". Machined from a solid block of billet aluminum. Features our own silver button head screws and our quality internal components. Security cable included to deter theft. Available in natural finish and with several styles of emblems. Will not fit 1970 cars with California emissions.

Gas Cap, Black Aluminum Billet



64-73: Cobra emblem*
B-9030-COBRA-BK



64-73: GT emblem
B-9030-GT-BK



64-73: Horse emblem*
B-9030-H-BK



64-73: Plain
B-9030-P-BK

ALUMINUM RACING GAS CAP



This Vintage Racing Fuel Cap Looks Great & Offers The Security Of A Lockable Inner Cap. Very Similar In Appearance To The

Quick Fill Caps Used In Most Race Cars In The 1960's. Includes Rubber Body Seal & Allen Head Mounting Screws. Will Fit On Tail Panel But New Mounting Holes Will Need To Be Drilled. Base Diameter Is 5.625 Inches. A 2 Inch Diameter Fuel Hose & Modification To the Filler Pipe Is Required.

Gas Cap, Aluminum Racing

64-73 Pop open, racingCSX-9030-A

LOCKING GAS CAP



This original looking cap features a hidden key slot beneath a flip-up cover. Will not fit Mach 1 or Shelby cars.

Gas Cap, Locking



65-73 *
CSZZ-9030-L

GAS CAP LOCK

A unique way to stop gas cap theft. Works with twist off type gas caps only. Assembly required.



Gas Cap Lock

64-73ACC-9030-LOCK

GRILLE

FOG LIGHT BARS & BRACKETS

FOG LIGHT BAR



We believe that we offer the best quality at a price that is reasonable and

competitive. Ours are just like the originals - these are pressure die cast in zinc. This process is very expensive, but is the only way to produce a part with high detail and a smooth polished finish, which is the first step toward a superior chrome job.

Fog Light Bar

65 CSZZ-8390-D/E
66 C6ZZ-8390-A/B
67 C7ZZ-8390-C/D

FOG LIGHT BAR BRACKET

Mounts to grill, helps support fog lamps. Good quality steel stampings.

Fog Light Bar Bracket



65
CSZZ-15266/7-A



66: GT
C6ZZ-15266-A



67: GT
C7ZZ-15266/7-A



68: GT
C8ZZ-15266/7-A

FOG LIGHT HOUSING ASSEMBLY



These Fog Light Housing Assemblies are the best on the market. Assemblies include triple chrome-plated rims, silver painted housings

on back, an exact copy of the wiring harness, cup mounting washer, and serrated flange nut. They also feature the correct wire exit and drain hole. Bulb not included.

Fog Light Housing Assembly

65-67 Concours correct CSZR-15200-A
68 w/out correct wire pigtail .C8ZZ-15200-A
68 Blue plug, concours correct
C8ZZ-15200-AC

GRILLE PANEL & COMPONENTS

GRILLE BAR



Our grille bars are pressure die-cast for precision and a perfect fit. Excellent plating and durability, just like the originals. Includes mounting hardware.

Grille Bar

64-65 CSZZ-8390-B/C
67 C7ZZ-8390-B/C

GRILLE BAR MOUNTING BRACKET

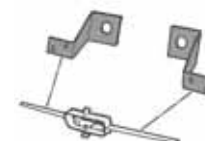

Stamped steel brackets that attach grill bars to grill. Painted black as original.

Grille Bar Mounting Bracket

64-65 Painted black CSZZ-8182/3-A

GRILLE



Perfect attention to detail. These grilles are perfect replacements for previously hard to find parts.

Grille	
64-65 std.	C5ZZ-8200-CR
64-65 GT, for fog lights	C5ZZ-8200-DR
66 All	C6ZZ-8200-AR
67	C7ZZ-8200-AR
68	C8ZZ-8200-AR
69 Black plastic	C9ZZ-8200-A
69 Reproduction	C9ZZ-8200-AR
69 w/out Sport Lights	DOZZ-8200-A
70 Mach 1	DOZZ-8200-B
70 Mach 1, reproduction	DOZZ-8200-BR
71-72 Mach 1, w/ stainless moldings*	D1ZZ-8200-C
71-72 std., moldings not included	D1ZZ-8200-DR
73 std.	D3ZZ-8200-A
73 Mach 1	D3ZZ-8200-B
73 Mach 1, reproduction	D3ZZ-8200-BR

BILLET GRILLE



These beautiful billet grilles mount in the existing grill location and look awesome.

Grille, Billet	
64-66	C5ZZ-8200-BLT
65-66 Lower, for R code car w/ no bumper	C5ZZ-8200-RLB
65-66 Lower, for R code car w/ bumper style	C5ZZ-8200-SLB
67-68	C7ZZ-8200-BLT
67-68 Eleanor upper & lower	S7MS-8200-E





GRILLE CORRAL

Great finish on this previously hard to find part.

Grille Corral	
	68: Small corral C8ZZ-8213-A
	68: Large corral C8ZZ-8419-A
	71-72: std. grille D1ZZ-8419-A
	73 D3ZZ-8419-A

GRILLE CORRAL AND HORSE

* Beautiful copy of the original, with Show quality chrome. Made by Scott Drake.
Grille Corral And Horse

	64-65: Reproduction* C5ZZ-8213-AR
	66: std.* C6ZZ-8213-A
	66: GT* C6ZZ-8213-B
	67 * C7ZZ-8213-A

GRILLE CORRAL AND HORSE KIT

* Our beautifully chromed grille horse and small grille corral in one convenient package.

Mounting hardware included.
Grille Corral And Horse Kit
68 * C8ZZ-8213/224-A

GRILLE HORSE



* A brilliant chrome running horse for the standard grille.

These are all show-quality. See "Emblem" category for grille emblems.

Grille Horse	
64-66 *	C5ZZ-8A224-B
67 *	C7ZZ-8A224-A
68 *	C8ZZ-8A224-A
71-72 *	D1ZZ-8213-A
71-73 Running horse w/ tribar, for Mach 1 *	D1ZZ-8213-B

GRILLE EMBLEM

* Perfect detail. Mounting hardware included.

Grille Emblem	
	69: Running horse* C9ZZ-8213-AR
	70: Running horse* DOZZ-8213-A



GRILLE LATCH TOP PLATE

A nice reproduction. Painted black.

	Grille Latch Top Plate 64-65 C5ZZ-8194-A
---	---

GRILLE SUPPORT BRACKET

Grille Support Bracket

	64-66: Black C5ZZ-8390-FR
	69 C9ZZ-8182-A
	70 DOZZ-8232-A

MOLDING & TRIM

GRILLE MOLDING

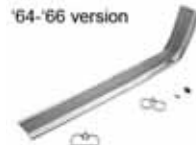

Fits on outside of grill opening. 64-70 molding includes mounting hardware. For all 71-73 molding, mounting clips are

sold separately.

Grille Molding	
64-66 RH, wide	C5ZZ-8242-AR
64-66 LH, wide	C5ZZ-8243-AR
67-68 RH, wide	C7ZZ-8190-AR
67-68 LH, wide	C7ZZ-8191-AR
67-68 RH, narrow	C7ZZ-8242-AR
67-68 LH, narrow	C7ZZ-8243-AR
69 Lower grille panel	C9ZZ-8221-A
69 RH, wide	C9ZZ-8242-AR
69 LH, wide	C9ZZ-8243-AR
69 RH, narrow	C9ZZ-8242-BR
69 LH, narrow	C9ZZ-8243-BR
69 Center, narrow	C9ZZ-8419-AR
70 Center, wide	DOZZ-8221-A
71-72 Upper or lower	D1ZZ-8419-B
71-72 RH	D1ZZ-8419-C
71-72 LH	D1ZZ-8419-E
73 RH	D3ZZ-8242-A
73 LH	D3ZZ-8243-A
73 Upper or lower	D3ZZ-8419-C

GRILLE MOLDING JOINT COVER

Our own reproduction. Chrome is better than original, recessed area is painted Argent Silver. All necessary fasteners are included.

Grille Molding Joint Cover



66: Center
C6ZZ-8221-A



67-68: Center Joint Cover
C7ZZ-8221-AR

WE PROUDLY FEATURE AUTHENTIC MUSTANG REPRODUCTIONS FROM SCOTT DRAKE ENTERPRISES!



HARDWARE

ENGINE & ENGINE COMPARTMENT HARDWARE

AIR CLEANER TO SNORKLE NUT



Attaches snorkle to air cleaner. Zinc plated.

Air Cleaner To Snorkle Nut

64-67 358462-S7

AIR CLEANER WING NUT

A nice reproduction.



Air Cleaner Wing Nut

64-68 6 cyl. w/stud 383132-S

64-73 1/4-20 thread wing nut 358871-S

BATTERY CLAMPBOLT KIT

Bolt to secure the battery in the tray.



Battery Clamp Bolt Kit

67-70 D0AZ-10756-A

CARBURETOR MOUNTING NUT

Exact copies, not off the shelf standards. Thin design nut like originals. Mounts carb to intake. 4 Piece Set.



Carburetor Mounting Nut

64-73 MCN001

CLUTCH FAN BOLT

4 piece set.



Clutch Fan Bolt

66-73 C50E-1804

ENGINE MASTER FASTENER KIT



These excellent kits include original equipment hardware. These high quality fasteners have been re-tooled and are made identical to the original. Each kit includes hardware to attach the following: valve covers, air cleaner, intake manifold, oil pan, timing cover, water pump, crank pulley, thermostat housing, heat shield, distributor, carburetor, exhaust manifolds, fuel pump, oil filter adapter, engine tag and ignition coil.

Engine Master Fastener Kit

64	SB w/ generator & AC	EMK-C20E-336
64	SB hi-po w/ generator & AC	EMK-C30E-323
64-65	6 cyl.	EMK-CODE-319
64-65	SB w/ generator, inc. exhaust locks	EMK-C20E-322
65	SB 289 w/ alum. water pump & alternator	EMK-C50E-559
65	SB 289 w/ AC	EMK-C50E-560
65	SB 289 hi-po w/ alum. water pump & alternator	EMK-C50E-561
65	SB 289 w/ cast iron water pump & alternator	EMK-C50E-812
65	SB 289 hi-po w/ cast iron water pump & alternator	EMK-CSZE-1067
65	SB GT-350	EMK-S1ME-1184
66	6 cyl.	EMK-C6DE-320
66	SB 289 w/ cast iron water pump & AC & Ramp-locs	EMK-C60E-337
66	SB GT-350	EMK-S2ME-1185
66-67	SB 289 w/ cast iron water pump & Ramp-locs	EMK-C60E-324
66-67	SB 289 hi-po w/ cast iron water pump & Ramp-locs	EMK-C60E-325
67	BB 390 GT	EMK-C70E-330
67	SB 289 w/ AC	EMK-C70E-562
67	SB GT-350	EMK-S7ME-1186
67	BB GT-500	EMK-S7ME-331
68	SB 289, 302	EMK-C80E-326
68	BB 428 Cobra Jet	EMK-C80E-333
68	SB 289, 302 w/ AC	EMK-C80E-338
68	SB GT-350	EMK-S8ME-1187
68	BB GT-500KR & 428 Cobra Jet	EMK-S8ME-382
68	BB GT-500	EMK-S8ME-677
68-69	BB 390 GT	EMK-C80E-332
68-70	6 cyl.	EMK-C8DE-321
69	SB 302	EMK-C90E-1126
69	SB 351	EMK-C90E-1128
69	SB 351 w/ AC	EMK-C90E-1129
69	SB Boss 302	EMK-C9ZE-1180
69	SB 302	EMK-D00E-1130
69-70	BB 429 & Boss 429	EMK-C9AE-1182
69-70	SB GT-350 w/out AC	EMK-C90E-1188
69-70	BB 428 Cobra Jet & Super Cobra Jet	EMK-C90E-334
69-73	6 cyl. 250	EMK-C9DE-342
69-73	SB 302 w/ AC	EMK-C90E-1127
70	SB 351W	EMK-D00E-1132
70	SB Boss 302	EMK-D0ZE-1181
70-71	SB 351 Clev. w/ 2 barrel carb.	EMK-D00E-1175
70-71	SB 351 Clev. w/ 4 barrel carb.	EMK-D00E-1176
71	Boss 351	EMK-D00E-1177
71	BB 429, 429 Cobra Jet & Super Cobra Jet	EMK-D00E-1183
72-73	SB 351 Clev. w/ 2 barrel carb.	EMK-D20E-1178
72-73	SB 351 Clev. w/ 4 barrel carb.	EMK-D20E-1179

SHOP WITH CONFIDENCE! WE OFFER SUPERIOR-QUALITY PARTS FOR ALL YOUR MUSTANG RESTORATION NEEDS.

HEATER CABLE CLAMP BRACKET KIT



Secures cable to heater control assembly, heater plenum and heater box. Black oxide bracket with screw.

Heater Cable Clamp Bracket Kit
64-68 378897-5

HEATER HOSE CLAMP



Designed for any one-inch hose, this clamp can be used for the breather hose between the valve cover and air cleaner

on 1964 - 1967 Mustangs.
Heater Hose Clamp
60-67 C3AZ-18572-A

INTAKE MANIFOLD BOLT KIT



Concourse correct with the exact head markings. Not an off the shelf generic copy.

These are 100% correct or your money back!
Intake Manifold Bolt Kit

64-67 260, 289 IMB-C40E-478
67 GT500 IMB-C3AE-493
67-68 390, 428 IMB-B8AE-475
68 GT500 IMB-S8ME-477
68-69 289, 302 IMB-C80E-479
69 351 W IMB-C90E-1131
69 Boss 302 IMB-C9ZE-1306
69-70 Boss 429 IMB-C9AE-1376
69-70 390, 428 IMB-C90E-476
70 Boss 302 IMB-D0ZE-1320
70-73 351 2V IMB-D00E-1313
70-73 302 IMB-D00E-1123
70-73 351 Clev. 4V IMB-D00E-1321

STARTER BOLT



These are the real thing. Not just a generic bolt. Yes, judges do check these details. 2 piece set. Special 1/2" head.

Starter Bolt
65-73 Special 1/2" head C8ZL-1410

UNDER HOOD DETAILING KIT



All concourse correct hardware individually packed and labeled. Kits typically include two dozen common areas to detail under

the hood.

Under Hood Detailing Kit
65 C5ZB-UH
66 C6ZB-UH
67 C7ZB-UH
68 C8ZB-UH
69 C9ZB-UH
70 D0ZB-UH
71 D1ZB-UH
72 D2ZB-UH
73 D3ZB-UH

VALVE COVER BOLT

These valve cover bolts come in either allen or hex head style. Note: will not work with stamped steel valve covers.

Valve Cover Bolt



64-73: Allen head, black
VCB-AB



64-73: Allen head, stainless
VCB-AS



64-73: Hex head, zinc plated
VCB-HC



64-73: Hex head, zinc plated, for stamped steel valve covers
VCB-HC-S

VALVE COVER BOLT SET



A great addition to a concourse engine. These exact copies feature

details of the originals. All head markings are correct. Not an off the shelf generic copy.

Valve Cover Bolt Set

64-73 170, 200, 250 6 cyl. VCB-CODE-480
64-73 SB, Boss 302 w/ stamped steel covers VCB-C20E-481
65-68 Cobra valve covers "RBW" ... VCB-S1ME-1438
69-73 Plain head w/ washers VCB-S9ME-1619
70-73 351 Clev. VCB-D00E-482
67-70 390, 427, 428 VCB-B8AE-339
70-71 Boss 302, 351 w/ alum. covers & Boss 351 "E" logo VCB-D0ZE-483
67-68 428 Shelby "RBW" logo VCB-S7ME-310
69-70 inc. studs VCB-C9ZE-1147
69-70 GT-350 VCB-S9MB-1619

VOLTAGE REGULATOR MOUNTING KIT



3 piece kit. Correct screws to mount voltage regulator.

Voltage Regulator Mounting Kit
65-67 VRM-C5ZL-404
68 VRM-C8ZL-406

VOLTAGE REGULATOR SCREW CAP



Plastic caps used to cover sharp points on screws that mount voltage regulator.

Voltage Regulator Screw Cap
64-66 C5Z2-10316-S

WINDAGE TRAY BOLT KIT



Add a windage tray. This kit has eight bolts, four that hold the tray and four that replace main cap bolts.

Windage Tray Bolt Kit
65-73 Eight bolt kit C9ZE-3256

WIRING LOOM TIES



These wire loom ties are found through out the engine compartment. Black nylon. Complete kits

available. See electrical section.
Wiring Loom Ties
64-73 376914-S

EXTERIOR HARDWARE

BACK UP LIGHT SPACER



Stamped steel and zinc plated. Mounts on backup lamp housing stud between rear valence and nut. 4 piece set.

Back Up Light Spacer
64-68 359972-S8

DOOR GRILLE MOUNTING KIT



This kit is required to mount our dlx door grilles. 24 piece kit includes black screws and unique mounts.

Door Grille Mounting Kit
67-68 C7ZN-3301

DOOR HINGE MOUNT KIT



OE looking bolts with built in washers. Black oxide finish.

Door Hinge Mount Kit
64-65 6 bolts, black, 3/8" threads 379043-SMK
66-68 6 bolts, black, 5/16" threads 380575-S2

WE PROUDLY FEATURE AUTHENTIC MUSTANG REPRODUCTIONS FROM SCOTT DRAKE ENTERPRISES!



CONCOURS FENDER & BODY BOLTS

Authentic copies of the original. These are the most commonly used bolts on all Fords, virtually used throughout car but most visible on fenders.

SKU Fender And Body Bolt	Year	Head	Marking head	Finish
-----------------------------	------	------	--------------	--------

5/16-18 x 15/16 inch long, 7/8 inch O.D.

378156-S2-HTS	1965 - 67	HTS	External star washer	Phosphate & oil, black finish
378156-S2-HTS/R	1965 - 67	HTS w/ rings	External star washer	Phosphate & oil, black finish
378156-S2-S	1965 - 67	SEMS	External star washer	Phosphate & oil, black finish

5/16-18 x 1 1/16 inch long, 7/8 inch O.D.

378178-S2-ANCH	1965 - 67	ANCHOR	External star washer	Phosphate & oil, black finish
----------------	-----------	--------	----------------------	-------------------------------

5/16-18 x 1 inch long, 13/16 inch O.D.

378178-S2E	1966 - 67	SEMS	Conical toothed disc washer	Phosphate & oil, black finish
378178-S7	1968	S	Conical toothed disc washer	Cadmium & wax, silver
378178-S2-DITTO	1966 - 67	DITTOS	Conical toothed disc washer	Phosphate & oil, black finish
378178-DS7	1968	ANCHOR	Conical toothed disc washer	Cadmium & wax, silver
378178-S2	1968	RBW	Conical toothed disc washer	Phosphate & oil, black finish

5/16-18 x 1 1/4 inch long, 13/16 inch O.D.

378242-S2-SEMS	1966 - 67	SEMS	Conical toothed disc washer	Phosphate & oil, black finish
----------------	-----------	------	-----------------------------	-------------------------------

1/4-20 x 7/8 inch long, 3/4 inch O.D.

B-11598	1967 - 73	N	Conical disc washer	Phosphate & oil, black finish
57030-S236	1967 - 73	FLAG	Conical disc washer	Zinc dichromate, yellow/gold

1/4-20 x 7/8 inch long, 3/4 inch O.D.

57039-S7	1969 - 70	FLAG	Conical disc washer	Cadmium & wax, soft silver
57039-S36	1969 - 70	FLAG	Conical disc washer	Zinc dichromate, yellow/gold
57039-S2	1969 - 73	FLAG	Conical disc washer	Phosphate & oil, black finish



AFTERMARKET FENDER & BODY BOLTS

Not concours correct head pattern, but very good looking. All 5/16-18 x 7/8 long.



SKU Fender And Body Bolt	Year	Finish
-----------------------------	------	--------

Aftermarket 5/16-18 x 7/8 inch long

378178-DB	1966 - 73	Black oxide finish
378178-DC	1966 - 73	Bright cadmium finish
378178-SS	1966 - 73	Polished stainless steel

MASTER BODY KIT



All concours correct. These new kits include all sheet metal attaching hardware necessary to properly reassemble

a Mustang body. Most kits include Battery tray, bumper guard-front, bumper guard rear, bumper guard mount brackets, bumper guard pads, cowl braces, door hinges, door latches, fenders, fender pillar brackets, fender extensions, fender splash shields, fender splash shield brackets, floorboard hole covers, grille, grille supports, headlamp doors, hood and hood hinges, hood bumper, hood latch and catch, hood latch support, quarter panel extensions, stone deflector, suspension bumper brackets-front, trunk latch and striker, trunk lid and hinges, valance front and valance rear. Also includes assembly instructions.

Master Body Kit

64-65	MBK-C5ZB-MASTER
66	MBK-C6ZB-MASTER
67	MBK-C7ZB-MASTER
67	Shelby MBK-S7MB-MASTER
68	MBK-C8ZB-MASTER
68	Shelby MBK-S8MB-MASTER
69	MBK-C9ZB-MASTER
69-70	Shelby MBK-S9MB-MASTER
70	MBK-D0ZB-MASTER
71	MBK-D1ZB-MASTER
72	MBK-D2ZB-MASTER
73	MBK-D3ZB-MASTER

DOOR LATCH SCREW

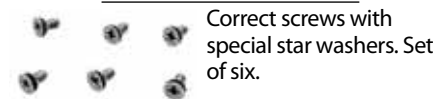

Correct screws with special star washers. Set of six.

Door Latch Screw

64-70	Set of 6356782-S
-------	----------	---------------

EMBLEM BARREL CLIP



A must when re-mounting emblems. Correct in every way.

Emblem Barrel Clip

64-73	Pin dia. range .184-.190 (large)	..375480-S
64-73	Pin range dia. .120-.130 (medium)	..375890-S
64-73	Pin range dia. .062-.072 (small)378362-S

MASTER CHASSIS KIT



These kits are huge! Once again these are not generic off the shelf typical bolts. Each one is an exact copy from the

original equipment manufacturer. A typical kit would include the following: Accelerator bellcrank, rear axle retainers/rear brake plates, front brake plates, brake booster, brake cables, brake calipers, brake drums, brake hoses, spring perches, control arms, front crossmember, axle housing, differential carrier, driveshaft, engine mounts, gas cap, gas tank, filler neck, idler arm, leaf spring front eye, master cylinder, parking brake control, pitman arm, proportioning valve, rag joint, front shocks, shock brackets, steering gear, steering linkage, strut rods, sway bar insulator brackets, transmission crossmember, transmission insulator and wheel cylinders. Remember only fasteners are included.

Master Chassis Kit

65	289 hi-po, disc	MCK-C5ZS-DCHP
65	260-289, disc	MCK-C5ZS-DCSB
65	260-289, drum	MCK-C5ZS-DRSB
65	170, 200, drum	MCK-C5ZS-DRSX
66	289 hi-po, disc	MCK-C6ZS-DCSB
66	289, drum	MCK-C6ZS-DRSB
66	170, 200, drum	MCK-C6ZS-DRSX
67	390, 428, disc	MCK-C7ZS-DCBB
67	289 hi-po, disc	MCK-C7ZS-DCSB
67	289, drum	MCK-C7ZS-DRSB
67	200, drum	MCK-C7ZS-DRSX
68	390, 428, disc	MCK-C8ZS-DCBB
68	289, 302, disc	MCK-C8ZS-DCSB
68	289, 302, drum	MCK-C8ZS-DRSB
68	200, drum	MCK-C8ZS-DRSX
69	390, 428, disc	MCK-C9ZS-DCBB
69	302, 351, disc	MCK-C9ZS-DCSB
69	302, 351, drum	MCK-C9ZS-DRSB
69	200, drum	MCK-C9ZS-DRSS
69	250, drum	MCK-C9ZS-DRSX
69	428, disc	MCK-C9ZS-HDBB
69	Boss 429, disc	MCK-C9ZS-HDBG
69	Boss 302, Boss 351, disc	MCK-C9ZS-HDSB
70	Boss 429, disc	MCK-DOZD-HDBG
70	302, 351, disc	MCK-DOZS-DCSB
70	302, 351, drum	MCK-DOZS-DRSB
70	200, drum	MCK-DOZS-DRSS
70	250, drum	MCK-DOZS-DRSX
70	428, disc	MCK-DOZS-HDBB
70	Boss 302, Boss 351, disc	MCK-DOZS-HDSB
71	429, disc	MCK-D1ZS-DCBB
71-73	302, 351, disc	MCK-D1ZS-DCSB
71-73	250, disc	MCK-D1ZS-DCSX
71-73	302, 351, drum	MCK-D1ZS-DRSB
71-73	250, drum	MCK-D1ZS-DRSX

EXTERIOR TRIM SCREW KIT



Exterior screw kits include outside mirror, parking lamp lens, back up lamp lens, headlamp door and tail lamp screws.

Exterior Trim Screw Kit

64-66	ITS-65-EXT
67-68	ITS-67-EXT

SMALL FENDER & VALANCE BOLT



This bolt has a 1/4-20 thread and is 3/4 inch long from the head down. It is used several

places throughout the car, but primarily in the front sheet metal such as the valance, headlamp assembly to fenders, etc.

Fender And Valance Bolt, Small

64-73	43263-SBOLT
-------	-------	-------------

FENDER TO COWL BOLT



Made of heavy gauge spring steel. Includes bolt and retainer.

Fender To Cowl Bolt

65-66	378685-S2
-------	-------	-----------

FENDER TO COWL NUT SET



Pair of captive nuts on stamped steel winged plates. Snaps into rocker. Very special nut hard to find.

Fender To Cowl Nut Set

64-68	359613-SK
-------	-------	-----------

FRONT VALANCE MOUNTING KIT



This kit is used to mount front valance to fenders, stone deflector and lower front cross member.

Front Valance Mounting Kit

64-68	43263-SMK
-------	-------	-----------

GRILLE MOUNTING CLIP



A must for holding the grille moulding in place. Made from tough ABS plastic. Will not fit 71-72.

Grille Mounting Clip

73	D3ZZ-8251-A
----	-------	-------------

GRILLE MOUNTING KIT



These are not just generic pieces. OE correct. Show quality.

Grille Mounting Kit

65	12 piece kit	C5ZB-8200-MK
66	16 piece kit	C6ZB-8200-MK
67	10 piece kit	C7ZB-8200-MK
68	10 piece kit	C8ZB-8200-MK
69-70	7 piece kit	C9ZB-8200-MK

HEADLIGHT ADJUSTING KIT



Includes threaded adjusting stud and nylon insert. Nylon insert is slightly larger

than O.E.M. and requires minimal filing for proper fit.

Headlight Adjusting Kit

64-66	C3MY-13181/032K
-------	-------	-----------------

HEADLIGHT ADJUSTING NUT



These are the nuts that are used to adjust the headlamp beam trajectory. It is also available in the headlamp adjusting

kit, Part # C5ZZ-13008-MK.

Headlight Adjusting Nut

64-66	C3MY-13181-A
-------	-------	--------------

HEADLIGHT DOOR RETAINER CLIP KIT



Mounts on headlamp assembly, headlamp door screws attach to this clip. 8 piece set.

Headlight Door Retainer Clip Kit

64-66	357033-SK
-------	-------	-----------

HEADLIGHT DOOR SCREW KIT



Special Phillips Head screw, exact copy. Made from rust proof stainless steel. 8 piece set.

Headlight Door Screw Kit

64-66	378852-SK
-------	-------	-----------

HOOD HINGE MOUNTING KIT



Hood Hinge Mounting Kit

64-68	359662-SMK
-------	-------	------------

J NUT FASTENER



Correct fasteners that are used under fender bolts. Fender bolts thread into J nuts. Also used on many other applications throughout the Mustang.

J Nut Fastener

64-73 5/16-18 379831-5
64-73 1/4x20 43263-5 NUT

LICENSE PLATE MOUNTING KIT



Kit includes 4 screws, 2 metal nuts, 2 self-threading plastic nuts and 2 anti-rattle bumper.

License Plate Mounting Kit

64-73 380707-SK

LICENSE PLATE NUT FASTENER



Self threading white plastic. Used in front and rear valances. Perfect match.

License Plate Nut Fastener

64-73 380707-5

MOLDING HARDWARE



We offer these complete hardware kits for your customer's convenience. Kits include high strength

backing plates and all necessary screws, clips, or rivets.

Molding Hardware

64-66 RH or LH C5ZZ-6510182-K
67-68 LH C7ZZ-6510182-KL
67-68 RH C7ZZ-6510182-KR
71-73 For use at 1/4 window D1ZZ-6522204

BULK REAR VALANCE FASTENER



This is the correct one, not an after market product off the shelf, but made from our own tooling. Plated to prevent rust.

Rear Valance Fastener, Bulk

64-73 372719-S100-B

REAR VALANCE MOUNTING KIT



Rear Valance Hardware kit contains 2 clips and 2 nuts.

Rear Valance Mounting Kit

64-70 372719-S100

REAR VALANCE MOUNTING SET

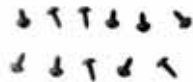

Set contains 11 screws.

Rear Valance Mounting Set

64-68 376525-SK

SERRATED FLANGE NUT



A 5/16x18 serrated flange nut that is used in several locations throughout.

Serrated Flange Nut

64-73 34392-5

STONE DEFLECTOR MOUNTING KIT



Stone Deflector Mounting Kit

64-66 10 piece kit SDM-C5ZB-119
67-68 10 piece kit SDM-C7ZB-208

TAIL LIGHT HOUSING MOUNTING NUT



These hard to find nuts are concours correct and feature high-quality zinc plating.

Tail Light Housing Mounting Nut

64-66 Set of 8 359606-S8
67-68 Set of 12 377523-S

TOP FENDER HARDWARE KIT



Our top fender hardware kit is a convenient way to get the right hardware in one package. 24 pieces. 12 black bolts and 12 J clips.

Top Fender Hardware Kit

64-68 378178-TFM

FUEL SYSTEM HARDWARE

FUEL PUMP MOUNTING KIT



Concourse correct fasteners, mounts fuel pump to engine.

Fuel Pump Mounting Kit

64-73 6 cyl., 170,200,250 FPM-CODE-518
64-73 SB 260,259,302,351W .. FPM-C5OE-519
70-73 351C FPM-D0OE-520

INTERIOR HARDWARE

INTERIOR FASTENER KIT



Now available from Scott Drake, Interior Assembly Fastener Kits! These comprehensive kits include almost every

fastener needed for your vehicle's interior. Each application within the kit is separately packaged so you know exactly where it goes, and most oval head sheet metal screws in our kits are stainless with chrome, black, or zinc finish.

Interior Fastener Kit

65-66 FB, std. KIT-65Z-63A
65-66 FB, dlx. KIT-65Z-63B
65-66 CP, std. KIT-65Z-65A
65-66 CP, dlx. KIT-65Z-65B
65-66 CV, std. KIT-65Z-76A
65-66 CV, dlx. KIT-65Z-76B
67 FB, std. KIT-67Z-63A
67 FB, dlx. KIT-67Z-63B
67 CP, std. KIT-67Z-65A
67 CP, dlx. KIT-67Z-65B
67 CV, std. KIT-67Z-76A
67 CV, dlx. KIT-67Z-76B
68 FB KIT-68Z-63
68 CP KIT-68Z-65
68 CV KIT-68Z-76
69 FB KIT-69Z-63
69 CP KIT-69Z-65
69 CV KIT-69Z-76
70 FB KIT-70Z-63D
70 CP KIT-70Z-65D
70 CV KIT-70Z-76D

INTERIOR TRIM SCREW KIT



Convenient kits that are packaged for impulse sales. Skin packaging includes screw descriptions on front of card for extra

convenience. Kit includes the basic screws used on most interior restorations. All screws are brilliantly chromed plated. This kit contains pillar trim, kick panel, coat hooks, visor bracket, rear view mirror, door sill plates and windshield trim screws.

Interior Trim Screw Kit

64-66 CP ITS-65-CP
64-66 CV ITS-65-CV
64-66 dlx. ITS-65-PO
65-66 FB ITS-65-FB
67-68 CP ITS-67-CP
67-68 CV ITS-67-CV
67-68 FB ITS-67-FB

SHOP WITH CONFIDENCE! WE OFFER SUPERIOR-QUALITY PARTS FOR ALL YOUR MUSTANG RESTORATION NEEDS.

ARM REST BASE TO DOOR PANEL SCREW



Cadmium plated truss head screws. Just like original. 4 Piece Set.

Arm Rest Base To Door Panel Screw
64-66377905-5

ARM REST PAD TO BASE SCREW KIT



Attaches pad to chrome base. Black oxide. 4 piece set.

Arm Rest Pad To Base Screw Kit
64-6632930-SK

DASH PANEL NUT



These are exact reproductions. Gold zinc plated. Almost too nice to hide behind the dash. Sold in sets of 8 pieces.

Dash Panel Nut
67-68 376642-536

DOOR SILL PLATE SCREW

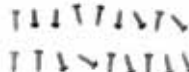

Chrome plated oval head screw to hold sill plates in position.

Door Sill Plate Screw
64-68 Set of 18376290-SK
64-70 Bulk376290-S

FIREWALL INSULATION FASTENERS



Firewall Insulation Fasteners
64-73 Plastic replacement357036-S100-P
68-73 Rubber C8Z-6501691

HORN RING RETAINER SCREW



Mounts plastic retainer to horn ring assembly.

Horn Ring Retainer Screw
64-6851763-5

INSIDE DOOR HANDLE AND WINDOW CRANK SCREW

We have these exact reproductions made especially for us. You want to use right parts, not something "close". Chrome plated just like the originals. Sold in sets of 4.

Inside Door Handle And Window Crank Screw



65-66: Set of 4
379259-5



67-70: Set of 4
381571-5

KICK PANEL SCREW



Chrome plated broad head screws to secure plastic kick panels in position. Kit does one car.

Kick Panel Screw
64-68 Set of 6350075-SK

SEAT RETAINING NUT



Another exact reproduction by Scott Drake. Painted to prevent rust. Color is dark red.

Seat Retaining Nut
64-68 Set of 4378643-SK

SEAT TRACK BOLT



Seat Track Bolt
64-70 Set of 4379874-SK

WINDOW GUIDE



Prevent the glass from rattling in the door. White ABS plastic. 16 required for each car.

Window Guide
69-70 C9Z-6521496

SHIFTER, CLUTCH & DIFFERENTIAL HARDWARE

PRESSURE PLATE BOLT SET



These are the real thing, not just a generic copy.

Pressure Plate Bolt Set
65-72 Set of 6 B7AT-3263

REAR END HOUSING NUT & WASHER KIT



Original style, cadmium plated self-locking nuts. Kit includes 10 nuts and 10 washers.

Rear End Housing Nut And Washer Kit
64-73 20 piece kit, silver cad. nuts MDK001
68-73 20 piece kit, red nuts MDK002

SHIFT COVER SCREW



Correct color and size.

Shift Cover Screw
64-68 Automatic52720-SK

SHIFTER SPRING

This is the tension spring that goes behind the trunnion at the base of the manual shifter. See transmission section for shifter rebuild kits. Shifter Spring



65-68: 3 speed
C2AZ-7208-C



65-68: 4 speed
C2AZ-7208-D

SHIFTER TRUNNION

These are the metal cups that are located at the end of the shifter to firm up a loose, wobbly shifter. They are also sold in kit # C5ZZ-7208-A that includes the springs and washers. Shifter Trunnion



64-68: 4 speed
C2AZ-7B125-A



64-68: 3 speed
C2AZ-7B125-B

SUSPENSION HARDWARE

SHOCK TOWER BOLT



Special bolts that slip into shock tower to retain shock tower cap. Silver zinc.

Shock Tower Bolt
64-66 Set of 6, silver355471-SK
67-73 Set of 6, black378353-SK

SHOCK TOWER NUT



Special hex nut with external star washer. Zinc plated.

Shock Tower Nut
64-66 Set of 633923-SK

WE PROUDLY FEATURE AUTHENTIC MUSTANG REPRODUCTIONS FROM SCOTT DRAKE ENTERPRISES!



HEATING & AC

AIR CONDITIONING

AC VENT

Replacement air conditioning vents for the instrument panel.

AC Vent



67: LH side
C7Z-19C696-A

67-68: RH side
C7Z-19893-A

68: LH side
C8Z-19C696-A

For control knobs and dash plate, look for "Heater & AC Control knobs" with the heater parts later in this section.

AIR CONDITIONER BLOWER SWITCH



Air conditioning blower switch (five terminal) for 1966 Mustang.

Air Conditioner Blower Switch
66 5 terminalC6Z-19986

AIR CONDITIONER DRAIN HOSE



Molded rubber flex hose, just like original.

Air Conditioner Drain Hose
65-68C8Z-19858-A

AIR CONDITIONER FEED HARNESS



Plugs into main A/C unit under dash, connects into back of ignition switch then, runs through firewall to compressor switch.

Air Conditioner Feed Harness
64-66C5Z-19800-ACF
67C7Z-19800-ACF

AIR CONDITIONER HOSE STRAPS



Holds A/C hose from cowl braces.

Air conditioner Hose Straps
67-70C7ZA-430

AIR CONDITIONER KIT



This complete package includes the underdash unit, drain tube, mounting brackets, compressor, all necessary hoses, receiver /dryer and condenser. This kit performs better than the original ever did and requires less horsepower to operate.

Air Conditioner Kit
64-66 OE style for V8CAP-365M-289
64-66 OE style for 6 cyl.CAP-365M-6
67-68 289 w/ P/SCAP-367M-289P
69-70 1300 series for Mustang & CougarCAP-1369-390

HURRICANE HEATER AND AIR CONDITIONER KIT



The Hurricane is a complete system that replaces your original heater box and adds a modern, high efficiency A/C

and heater/defroster in its place. It is a custom fit that utilizes all the factory firewall holes. No extra holes are needed. A new 3 speed switch neatly intergrates into the factory heater control plate. Compact design allows easy installation and retains the glove box.

Air Conditioner Kit, Hurricane Heater and
65-66 260, 289 w/ alternator CAP-1065M-289
67-68 289 Mustang & Cougar w/out P/SCAP-1067M-289
67-68 289 Mustang & Cougar w/ P/SCAP-1067M-289P
67-68 6 cyl.CAP-1067M-6
69-70 302, 351W Mustang & CougarCAP-1069M-302
69-70 351 Clev., Mustang & CougarCAP-1069M-351C
69-70 390, 428 Mustang & CougarCAP-1069M-390

AIR CONDITIONER REGISTER

Our high quality registers feature a great fit to provide an exact replacement for the originals. Injection molded for a precision fit and long life.



64-65: Front, chrome
C3AZ-19A671-A



64-65: Side, black
C5ZZ-19A671



66: Front, chrome
C6AZ-19A671-A



66: Side, black
C6ZZ-19A671

AIR CONDITIONER REGISTER CLIP



These clips are needed for correct installation of registers. Sold in a set of 8 for your convenience.

Air Conditioner Register Clip
64-66 Set of 8C3AZ-19A683-K

AIR CONDITIONER THERMOSTAT



Made by original supplier. Stops evaporator coil from freezing up.

Air Conditioner Thermostat
64-66C5ZZ-19A671-A
67-73C7Z-19A671

AIR CONDITIONER VACUUM MOTOR



Works for most applications. Modification to bracket may be required. Replacement style.

Air Conditioner Vacuum Motor
67-73C7AZ-18A318-AR

AIR CONDITIONER VACUUM SWITCH



Mounts on the main air chamber and opens and closes the air vent. Made of nylon with a steel and brass plunger.

Air Conditioner Vacuum Switch
67-70C7Z-18C311

AIR VENT ASSEMBLY



Complete air vent including the cable, knob, and bracket. Very well built.

Air Vent Assembly

- 65-66 CSZZ-6501934-A
- 67-68 C7ZZ-6501934-A

ALUMINUM LIQUID LINE



Connect to 90 degree liquid fitting at bottom of radiator core support and climbs shock tower to connect to sight glass

Aluminum Liquid Line

- 64-66 CSZZ-19837-B

COIN TRAY



Exact reproduction with polished aluminum trim and textured vinyl insert.

Coin Tray

- 64-65 CSZZ-19869

COMPRESSOR ADJUSTER



Compressor Adjuster

- 65-67 6 cyl. CSZZ-7105-A

COMPRESSOR CLUTCH BRUSHES



These are exact reproductions made from the original tooling.

Compressor Clutch Brushes

- 64-70 CSZZ-2979

COMPRESSOR CONVERSION KIT



Update your factory AC system with this compressor conversion kit. Sanden compressor and custom hoses provide

a neat, clean underhood appearance. Kits include mounting brackets and hardware. Increase engine performance, gas mileage while eliminating vibration and belt noise.

Compressor Conversion Kit

- 64-65 V8, R134a 50-3065
- 64-65 289, R12 50-3065R12
- 64-65 6 cyl., R134a 50-3165
- 64-65 6 cyl., R12 50-3165R12
- 66 289, R134a 50-3066
- 66 289, R12 50-3066R12
- 66 6 cyl., R134a 50-3166
- 66 6 cyl., R12 50-3166R12
- 67 289, R134a 50-3067
- 67 289, R12 50-3067R12
- 67 6 cyl., R134a 50-3167
- 67-68 67-390, 68-289, 390, R12 .. 50-3068R12
- 68 V8, R134a 50-3068
- 68 6 cyl., R12 50-3168R12
- 69-70 302, R134a 50-3069
- 69-70 302, R12 50-3069R12
- 69-70 6 cyl., R134a 50-3169
- 69-70 6 cyl., R12 50-3169R12
- 71-73 6 cyl., R134a 50-3171
- 71-73 6 cyl., R12 50-3171R12

COMPRESSOR COVER



This cover plate bolts to the top of the original A/C compressor to dress up the engine compartment. A nice match to our Aluminum Finned Valve Covers. Features Cobra or Mustang logo or plain. Available in satin or polished. Mounting hardware included.

Compressor Cover



- 64-73: Cobra, polished* CSZZ-19703-CP



- 64-73: Mustang, polished* CSZZ-19703-MP



- 64-73: Mustang, satin* CSZZ-19703-MS

- 64-73: Plain, polished CSZZ-19703-PP

- 64-73: Plain, satin CSZZ-19703-PS

SANDEN COMPRESSOR MOUNT KIT



This is the kit you will need to install a Sanden compressor on your original York compressor bracket.

Compressor Mount Kit, Sanden

- 64-73 CSZZ-2882-SCMK

CONDENSER



Exact reproduction of the original aluminum serpentine condenser. The original material and construction

design is absolutely mandatory for proper system function and to prevent engine overheating.

Condenser

- 64-66 CSZZ-19712-A
- 67-68 C7ZZ-19712-A
- 69-70 C9ZZ-19712-A
- 71-73 D1ZZ-19712-A

HIGH PERFORMANCE CONDENSER

DRYER KIT



Includes OEM style receiver drier and mounting bracket for easy installation into original

factory locations. New design technology incorporates a high heat-rejection, low refrigerant and air pressure drop as compared to the original condensers.

Condenser Dryer Kit, High Performance

- 64-66 CSZZ-19712-HPK
- 67-68 C7ZZ-19712-HPK
- 69-70 C9ZZ-19712-HPK

CONDENSER HOSE GROMMET

These grommets protect the condenser hoses as they pass through the radiator support on earlier Mustangs. Sold as a set of two.

Condenser Hose Grommet



- 64-66 378264S/379075S



- 67-68 C7ZZ-19819



- 69-70 C9ZZ-19819

Heater & AC

WE PROUDLY FEATURE AUTHENTIC MUSTANG REPRODUCTIONS FROM SCOTT DRAKE ENTERPRISES!



CONDENSER MOUNTING BRACKET



Painted black to stop corrosion. Four special brackets used to mount condenser.

Condenser Mounting Bracket
64-66CSZZ-19B594-R

DASH SPACER BAR



Fills gap between dash & A/C unit. Painted black. Helps hold interior air conditioning unit to dash.

Dash Spacer Bar
64-65CSZZ-19C604
66C6ZZ-19C604

DISCHARGE HOSE



Concourse high pressure hoses with correct authentic looking fittings. Made in the U.S.A. Hoses need replacing when they show dry rot and

cracking. Check crimped sleeves to hose for looseness by twisting fitting.

Discharge Hose
64-66 6 cyl., concoursCSZZ-19972-6
64-66 8 cyl., concoursCSZZ-19972-8
67-68 6 cyl., concoursC7ZZ-19972-6
67-68 8 cyl., concoursC7ZZ-19972-8
67-68 8 cyl., economyC7ZZ-19972-8R
69-70 6 cyl., concoursC9ZZ-19972-6
69-70 8 cyl., concoursC9ZZ-19972-8
69-70 8 cyl., economyC9ZZ-19972-8R
71-73 6 cyl., concoursD1ZZ-19972-6
71-73 8 cyl., concoursD1ZZ-19972-8

FILTER DRYER



Exact replacement to original dryer. Dryer removes moisture and should be changed anytime system is recharged. It is the life

of your system. Stainless steel filter element. Filter stops contaminants from clogging expansion valve.

Dryer, Filter
64-66C4AZ-19959-B
67-68C7ZZ-19959-A
69-70C9ZZ-19959-A
71-73D1ZZ-19959-A

DRYER MOUNTING BRACKET



Made by Scott Drake. Exact detail. Painted flat black. Mounting hardware included.

Dryer Mounting Bracket
64-66CSZZ-19838-A

EVAPORATOR



All new high output coils with more tubing passes makes these evaporators perform much better than the

original coils. New copper tube coils eliminate corrosion problem that plague aluminum versions.

Evaporator
67-68C7ZZ-19860-A
69-70 Late 69C9ZZ-19860-B
71-73D1ZZ-19860-A

EXPANSION VALVE



Expansion Valve
64-66CSZZ-19849
67-68C7ZZ-19849
69-70C9ZZ-19849
71-73D1ZZ-19849

FIREWALL AIR CONDITIONER HOSE GROMMET



Firewall Air Conditioner Hose Grommet
64-66CSZZ-19B588-A

FIREWALL GROMMET BRACKET



Painted black to prevent corrosion.

Firewall Grommet Bracket
64-66CSZZ-19B589-A

HEATER AND AIR CONDITIONER VACUUM LINE HOSE KIT

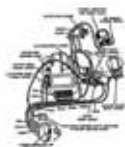

This kit includes color coded rubber hose, 2 plastic "T" connectors and vacuum diagram.

Heater And Air Conditioner Vacuum Line Hose Kit
67-68C7ZZ-18B372-A

IDLER BEARING REPAIR KIT



Repair your own idler bearings. Includes dust cover.

Idler Bearing Repair Kit
64-70CSZZ-2990-A

IDLER PULLEY AND BRACKET



Quality rebuilds, core not required.

Idler Pulley And Bracket
64 AdjustableCSZZ-8678-A
65-66 AdjustableCSZZ-8678-B
65-66 Non-adjustableCSZZ-8678-C
68 AdjustableC8ZZ-8678-A

LIQUID LINE HOSE ASSEMBLY



Connects to filter dryer outlet and extends through radiator core support.

Liquid Line Hose Assembly
64-66CSZZ-19837-A

QUICK DISCONNECT FITTING

Manufactured by the original maker to the original specifications. Features concourse markings stamped into fitting.

Quick Disconnect Fitting



67-73: Female
C7ZZ-19B596-F



67-73: Male
C7ZZ-19B596-M



67-73: Male/Female
C7ZZ-19B596-M/F

SERVICE VALVE



Fits on top of compressor. Exact copy. For aluminum valve cap see below. Aftermarket plastic cap included. #8

are smaller and are the discharge hose, #10 is the larger size for the suction side of hose.

Service Valve
64-66 Flare/Rotolock, discharge .C5ZZ-19752-A
67-68 Flare/Rotolock, suctionC7ZZ-19752-A
69 O-ring/Rotolock, discharge ..C9ZZ-19752-D
69 O-ring/Rotolock, suction ..C9ZZ-19752-S
70-73 O-ring/Tube-O, discharge D1ZZ-19752-D
70-73 O-ring/Tube-O, suctionD1ZZ-19752-S

SERVICE VALVE CAPS



Aluminum caps which fit on the service valves, these are exact copies. A must for any detailed engine compartment.

Service Valve Caps

64-73C5Z-19752-C

SIGHT GLASS HOSE



High quality US made hose. Not exact copy of original but great for daily drivers.

Sight Glass Hose

64 6 & 8 cyl.C5Z-19837-C
 67-68 6 & 8 cyl. w/ 90 degree fitting
 C7Z-19837-A
 69-70 6 & 8 cyl.C9Z-19837-A
 69-70 6 & 8 cyl., reproductionC9Z-19837-R
 70-73 6 & 8 cyl.D1Z-19837-A

SUCTION HOSE



Constructed in original Ford style black thermoplastic material with nylon barrier. All hose assemblies are

built compliant for R-12 or 134a refrigerants.

Suction Hose

64-65 8 cyl., concoursC5Z-19864-8
 64-65 8 cyl., economyC5Z-19864-8R
 64-65 6 cyl., concoursC5Z-19867-6
 66 6 cyl., concoursC6Z-19864-6
 66 8 cyl., concoursC6Z-19864-8
 66 8 cyl., economyC6Z-19864-8R
 67-68 6 cyl., concoursC7Z-19864-6
 67-68 8 cyl., concoursC7Z-19864-8
 67-68 8 cyl., economyC7Z-19864-8R
 69-70 6 cyl., concoursC9Z-19864-6
 69-70 8 cyl., concoursC9Z-19864-8
 69-70 8 cyl., economyC9Z-19864-8R
 71-73 6 cyl., concoursD1Z-19864-6
 71-73 8 cyl., concoursD1Z-19864-8

VACUUM CANISTER



Mounts to passenger fender well. Controls doors inside AC unit, includes built in check valve.

Vacuum Canister

67-70C8Z-19A566
 71-73D1Z-19A566

HEATER

LEFT HAND AIR VENT INLET GASKET



This is the seal for the air vent housing on the drivers (left hand) side, under the dash on Mustangs from 1964 through 1968.

Air Vent Inlet Gasket, Left Hand

64-68C20Z-6501999

DEFROSTER CONTROL CABLE



These parts are exactly like the originals. They feature correct cable covers, color coding, wire type and ends.

Defroster Control Cable

64-66 DefrosterC4DZ-18548-A

DEFROSTER DUCT

A nice reproduction. Features wire mesh screen like original.

Defroster Duct



64-66: Pair w/ clips
 C5Z-18490-A



67-68: LH w/out AC
 C7Z-18490-L



67-68: RH w/out AC
 C7Z-18490-R

DEFROSTER DUCT CLIP



These clips hold the defroster outlet nozzles to the dashboard. Four (one set) are required for a complete installation.

Defroster Duct Clip

64-70 Set of 4372850-5

DEFROSTER DUCT KIT



Complete kit includes two hoses with outlet ducts attached, and installation clips.

Defroster Duct Kit

64-66C5Z-18490-K

DEFROSTER HOSE



We also sell defroster hoses individually. Hose is authentic flex style, made from original type polypropylene coated fabric.

Defroster Hose

64-70B5A-18556-C

HEATER DASH PLATE



Our reproduction heater dash plate is a fine pressure die-cast zinc unit made to Scott Drake's high standards. Excellent chrome plating on face. Includes mounting studs and nuts.

Heater Dash Plate

64-66 ChromeC5Z-18A651
 64-66 SatinC5Z-18A651-S

HEATER CONTROL PLATE



Matches our other interior woodgrain and brushed aluminum pieces. Adhesive not included.

Heater Control Plate - Woodgrain

67 Aluminum w/out AC .C7Z-6504410-HC
 68 Woodgrain w/out AC .C8Z-6504410-HC

HEATER & AC CONTROL KNOBS

These exact reproductions are a great finishing touch. Made from die cast zinc and heavily chrome plated for durability. Black and chrome lettering on 64-68 versions is crisp and clear.

Heater & AC Control Knobs

64-66: Heater, chrome
 C5DZ-18519-K

64-66: Heater, satin
 C5DZ-18519-KS

67: AC
 C7Z-18519-ACK

67: Non AC
 C7Z-18519-AK

68: AC
 C8Z-18519-ACK

68: Non AC
 C8Z-18519-AK

69-70: Heater
 C9Z-18519-A





Heater & AC

For AC Registers and vents, look in the AC section a few pages back.

HEATER BLOWER MOTOR

High quality replacement part at a reasonable price.

Heater Blower Motor

-  64-65: 2-speed
CODZ-18527-A
-  65-68: 3-speed motor, will not work w/ early 65 cars w/ 3 wired, 2 speed motors
CSZ-18527-B
-  65-68: 3-speed motor w/ squirrel cage(fan)
CSZ-18527-K
-  67-73: w/ AC
C7Z-18527-A
-  69-73: w/out AC
C9Z-18527-A

HEATER BOX ASSEMBLY



Complete heater box assembly, features fiberglass box and steel stamped air chamber whirl cage. Motor is not included.

Heater Box Assembly

- 64-65 2 speedC5Z-18A542-K
- 65-66 3 speedC6Z-18A542-K
- 67-68 3 speedC7Z-18A542-K
- 69-70 w/ gasket & clipsC9Z-18A542/3-A

HEATER BOX CASE CLAMP



Special steel clamps that hold both halves of the heater box together.

Heater Box Case Clamp

- 64-68 CODF-19A779-A

HEATER CONTROL CABLE



These parts are exactly like the originals. They feature correct cable covers, color coding, wire type and ends

Heater Control Cable

- 64-66 Defroster C4DZ-18548-A
- 64-66 Heat, Temperature & Defrost
CSZ-18518-52-K
- 64-66 TemperatureC5Z-18518-B
- 64-66 Heat controlC5Z-18552-A
- 67-68 w/out ACC7Z-18518-A
- 67-68 w/ ACC7Z-18518-B

HEATER CONTROL VALVE

This is used on cars equipped with factory Air Conditioning to stop the flow of warm coolant when AC is on. Not exact replacement.

Heater Control Valve

-  67-68: OEM type
C7Z-18495-A
-  67-68: Aftermarket
C7Z-18495-R
-  69-73
D4AZ-18495-A

HEATER CORE



Our heater cores are the finest available anywhere for any price. Constructed from corrosion resistant copper and brass. A

great buy for anyone needing to make repairs to this vital part.

Heater Core

- 64-68 w/out ACC5DZ-18476-A
- 67-73 w/ ACC9Z-18476-B
- 69-70 w/out ACC9Z-18476-A
- 71-73 w/out ACD1Z-18476-B

HEATER CORE END CAP



These foam rubber end caps protect the core from damage due to excessive vibration. Prevents rattles and

improves heater performance with better sealing of the box.

Heater Core End Cap

- 65-68 w/out ACC5Z-18500-C
- 67-73 w/ ACC7Z-18500-C

HEATER CORE TO CONTROL VALVE HOSE



Both ends have 90 degree molded ends. Attaches heater core to water control valve.

Heater Core To Control Valve Hose

- 67-68C7Z-18472-CVAC
- 69-73C9Z-18472-CVAC

HEATER HOSE



These are the exact copies, approved by Mustang Club of America. They feature the correct grooves running the length

of the hose, correct colored stripe and part numbers, air conditioned cars have a 90 degree bend on one end of the hose when appropriate. Colored markings are very durable and don't come off easily. Below part numbers are for our reference only and do not reflect part numbers on actual hoses.

Heater Hose

- 64-68 64-early 68, white stripe ... C5Z-18472-W
- 67-68 67-early 68 w/ AC, white stripe
C7Z-18472-ACW

- 68 After 2-1-68 w/ AC, red stripe
C8Z-18472-ACR

- 68 All After 2-1-68, red stripe .. C8Z-18472-R

- 68-69 w/out AC, red stripe C5Z-18472-R

- 69 w/ AC, red stripeC9Z-18472-ACR

- 69 Red stripe C9Z-18472-R

- 70 before 2-1-70 w/ AC, yellow stripe
D0Z-18472-AACY

- 70 before 2-1-70, yellow stripe
D0Z-18472-AY

- 70 after 2-1-70 w/ AC, yellow stripe
D0Z-18472-BACY

- 70 After 2-1-70, yellow stripe D0Z-18472-BY

- 70-73 w/out AC, yellow stripeC5Z-18472-Y

- 71 w/ AC, yellow stripeD1Z-18472-ACY

- 71-73 Yellow stripeD1Z-18472-Y

- 72 w/ AC, yellow stripeD2Z-18472-ACY

- 72 Yellow stripeD2Z-18472-Y

- 73 w/ AC, yellow stripeD3Z-18472-ACY

- 73 Yellow stripeD3Z-18472-Y

HEATER HOSE KIT



Generic replacement hoses are American made. Black hose includes four original style post-type clamps.

Heater Hose Kit

- 64-68 GenericC5Z-18472-K

SHOW QUALITY HEATER HOSE KIT



These show quality hoses include original style 5/8-inch inside diameter ribbed hose with 1/4" wide white

stripe, plus four post-type band clamps.

Heater Hose Kit, Show quality

- 64-66 Show qualityC5Z-18472-WK

FIREWALL HEATER HOSE PLUG



Rubber plug for heater core or a/c holes on non-air conditioned cars.

Heater Hose Plug, Firewall
67-68 377678-S2

HEATER INLET GASKET



This gasket seals the fresh air tube in the cowl to the heater box inlet on 1964 through 1970 Mustangs.

Heater Inlet Gasket
64-70CSZZ-18A569-A

HEATER JUMPER HARNESS



Connects heater switch to engine gauge harness which plugs into heater motor. 2-speed only

Heater Jumper Harness
64-65CSZZ-18570-JMP

HEATER PLENUM



Our replacement heater plenums are molded from virgin ABS plastic for good looks and durability. Cable clamp and screw are attached, and inner door has closed cell foam bumpers installed.

Heater Plenum
64-66 All, 67-68 w/out ACCSZZ-18471-A

HEATER RESISTOR ASSEMBLY



Made by the original supplier to Ford.

Heater Resistor Assembly
65-68 3 speedC20A-18591-A

HEATER SEAL KIT



Everything you need to completely reseal the heater system and make it perform at top efficiency. Kit includes

all foam seals and rubber gaskets required for the entire heater system.

Heater Seal Kit
64-66 AllCSZZ-18500-A
67-68 w/out ACC7ZZ-18500-A
67-68 w/ ACC7ZZ-18500-B
69-70 w/ ACC9ZZ-18500-A
69-70 w/out ACC9ZZ-18500-B

BYPASS HOT WATER ELBOW

These beautiful reproductions replace rusty and corroded originals. Also available in chrome for V8.
Hot Water Elbow, Bypass



64-68: 170, 200 silver zinc
C20Z-18599-B



64-73: SB, gold zinc
C6AZ-18599-B
64-73: SB, chrome
C6AZ-18599-C
64-73: SB, silver zinc
C6AZ-18599-S



65-72: 6 cyl.
8M-18599



67-68: BB, gold zinc
C8AZ-18599-A
67-68: BB, chrome
C8AZ-18599-C



69-70: Boss 302, w/water restrictor,
silver zinc
C9ZZ-18599-A



69-70: 428C, silver zinc
D0AZ-18599-B



69-73: 351, 390, silver zinc
D0AZ-18599-A



70-71: 351, 390, chrome
D0AZ-18599-C

WATER VALVE BRACKET



Exact reproduction with zinc dichromate finish.

Water Valve Bracket
67-68C7ZZ-18A635-A

INTERIOR PARTS & UPHOLSTERY

BEZELS, KNOBS, SPACERS, & CIGARETTE LIGHTERS

DASH ASH TRAY

This is an exact copy to the original, not the hand fabricated part assembled with generic pop rivets that is also available. Best Quality at the Best Price. Painted Black with correct zinc plated housing. Note: console and quarter panel ash trays can be found in the "Console" and "Quarter Panel" sections of this category.
Ash Tray, Dash



64-66
CSZZ-6204810-A



67: Note: will not fit 68
C7ZZ-6204810-A

DASH BEZEL AND KNOB KIT

Our six piece kit includes ignition bezel, light switch knob and bezel, wiper knob and bezel, and a cigarette lighter element and knob assembly. **Note: Deluxe kit includes headlamp and wiper retaining nuts**

Bezel and Knob Kit, Dash
65-66CSZZ-10852-K
65-66 dlx.CSZZ-10852-DLXK

CIGARETTE LIGHTER

These are the best on the market and we invite comparison with any other lighter assembly available. Includes die-cast chromed knob and lighter element with shell. Exactly like the originals.
Cigarette Lighter



64-66
CSZZ-15052-K



67-70
C7AZ-15052-K

Interior

WE PROUDLY FEATURE AUTHENTIC MUSTANG REPRODUCTIONS FROM SCOTT DRAKE ENTERPRISES!



CIGARETTE LIGHTER BEZEL & ELEMENT

Excellent detailing and chrome plating. Like originals.

Cigarette Lighter Bezel and Element



64-66
C4DZ-15054-A



70
D0ZZ-10852-L

CIGARETTE LIGHTER KNOB

Excellent detailing and chrome plating. Like originals.

Cigarette Lighter Knob



64-66
C5ZZ-15052-A



70
D0ZZ-15052

CIGARETTE LIGHTER SOCKET AND RETAINER



Made by the original supplier. Fits our cigarette lighters.

Cigarette Lighter Socket and Retainer
64-70 C4AZ-15055-B

CONTROL PANEL BEZELS & LENSES



Control Panel Bezels and Lenses
67-68 C7ZZ-10C876-KIT

CONVERTIBLE TOP SWITCH

Exact copy from Scott Drake. For 64-66 knob & bezel sold separately

Convertible Top Switch

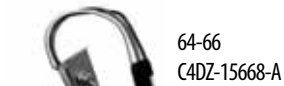

64-66
C4DZ-15668-A



67: inc. bezel & knob
C7ZZ-15668-A

CONVERTIBLE TOP SWITCH BEZEL & KNOB



Quality chrome plated with black painted "UP" and "DN" markings

Convertible Top Switch Bezel and Knob
64-66 C4DZ-10852-K

DIRECTIONAL LIGHT LEVER

Perfect copies of the originals to replace those rusted or tweaked originals.

Directional Light Lever



64-66: Chrome
C5ZZ-13305-A



67-73: Chrome
C7ZZ-13305-A

67-73: Satin
C7ZZ-13305-S

EMERGENCY FLASHER KNOB



Machined brass, exact shape and threads as originals.

Emergency Flasher Knob
67 Non-tilt C70Z-17513-A
67 Tilt C70Z-17513-B
68-69 Tilt C8MY-17513-C

FOG LIGHT SWITCH KNOB & BEZEL



Nice touches for corroded or missing original parts.

Fog Light Switch Knob and Bezel
65-67 C5ZZ-15259-AK

HEADLIGHT SWITCH BEZEL

New, chrome bezels really make a freshly painted dash pop. Beautiful reproductions.

Headlight Switch Bezel



64-66
C4DZ-10852-B



67-68
C7ZZ-10852-A



69-70
C9ZZ-10852-L

HEADLIGHT SWITCH COVER



Molded rubber cover which fits over headlamp dimmer switch.

Headlight Switch Cover
65-73 C5ZZ-13533

HEADLIGHT SWITCH KNOB

Knob is die-cast zinc, chrome plated with very good detail. Switch shaft is zinc plated to prevent rust or corrosion.

Headlight Switch Knob



64
C4ZZ-11661-A



65-66
C5ZZ-11661-B



67-68
C7ZZ-11661-A



69-70
C9ZZ-11661

For Heater & AC knobs and dash plates, look in the Heater section a few pages back.

IGNITION BEZEL TOOL



Don't scratch that new bezel with a screw driver. A dedicated tool made by Scott Drake.

Ignition Bezel Tool
67-68 T-100
69 T-109

IGNITION SWITCH BEZEL

High Quality Chrome. Don't forget to check out our bezel tool made specifically for this bezel to prevent damage.

Ignition Switch Bezel



64-66
C3AZ-11584-A



67-68
C60Z-11584-A



69
C9AZ-11584-A

IGNITION SWITCH RETAINER

A "must have" part when installing an ignition switch. Zinc plated for years of service. Ignition Switch Retainer



64-66
C4DZ-10A885-A



67-68
C7ZZ-11A590-B

RADIO BEZEL

Radio Bezel



67-68: Black/chrome, w/out console
C8ZZ-18842-AR



69-70: Black/chrome
C9ZZ-6504774-B



69-70: Walnut woodgrain
C9ZZ-6504774-F



71-73: Black/chrome
D1ZZ-18842-A

RADIO KNOB AND DIAL SET



Pressure die cast construction. Not cheap light weight plastic. Chrome plated and concourse correct.

Radio Knob and Dial Set

64-66C4AZ-18817/30-A
69-70C9ZZ-18817-K

WIPER BEZEL STEM NUT TOOL



Special tool designed to insert into wiper bezel stem nut used for assembly or disassembly. Will not damage nut.

Wiper Bezel Stem Nut Tool

64-66 T-110

WIPER KNOB

Excellent reproductions. Chrome plating, look like originals. Wiper Knob



64-66
C4AZ-17513-A



69-70
C9ZZ-17513

WIPER SWITCH BEZEL

A beautiful chrome and black reproduction of the original.

Wiper Switch Bezel



64-66
C4DZ-10852-A



69
C9ZZ-10852-W

WIPER SWITCH SPACER



Used to install wiper switch to dash. Once a hard part to find now available for trouble free installations. Plated.

Wiper Switch Spacer

64-66 C4DZ-17C443-A

CARPET, FLOOR MATS, & UNDERLAYMENT

CONVERTIBLE CARPET KIT



This is the good stuff. 1964-1968 are constructed from 80% Rayon 20 % Nylon,

1969-1970 are 100% Nylon. All edges are sewn to prevent unraveling. Drivers side has molded, colored keyed rubber heel and toe pad. All carpet is backed with a heavy 27 ounce jute insulation layer. Also features a precut gearshift hole. Fastbacks include small lower quarter panel sections.

Carpet Kit, Convertible

64 Black CAR64-CV-BK
65-68 Aqua CAR65-CV-AQ
65-68 Bright blue CAR65-CV-BB
65-68 Black CAR65-CV-BK
65-68 Dark brown CAR65-CV-BN
65-68 Dark green CAR65-CV-DG
65-68 Dark saddle CAR65-CV-DS
65-68 Emberglow CAR65-CV-EM
65-68 Ivy gold CAR65-CV-IG
65-68 Maroon CAR65-CV-MR
65-68 Nugget gold CAR65-CV-NG
65-68 Saddle CAR65-CV-SA
69-70 Black CAR69-CV-BK
69-70 Dark brown CAR69-CV-BR
69-70 Dark blue CAR69-CV-DB
69-70 Dark green CAR69-CV-DG
69-70 Ginger CAR69-CV-GI
69-70 Maroon CAR69-CV-MR
69-70 Vermillion CAR69-CV-VE
71-73 Black CAR71-CP-BK
71-73 Blue CAR71-CP-BL
71-73 Bright red CAR71-CP-BR
71-73 Dark green CAR71-CP-DG
71-73 Ginger CAR71-CP-GI

Carpet Kit, Convertible

65-68 Dark blue CAR65-CV-DB
65-68 Dark green CAR65-CV-DG
65-68 Dark saddle CAR65-CV-DS
65-68 Emberglow CAR65-CV-EM
65-68 Ivy gold CAR65-CV-IG
65-68 Maroon CAR65-CV-MR
65-68 Nugget gold CAR65-CV-NG
65-68 Saddle CAR65-CV-SA
69-70 Black CAR69-CV-BK
69-70 Dark blue CAR69-CV-DB
69-70 Dark green CAR69-CV-DG
69-70 Ginger CAR69-CV-GI
69-70 Maroon CAR69-CV-MR
70 Vermillion CAR69-CV-VE
71-73 Black CAR71-CV-BK
71-73 Medium blue CAR71-CV-BL
71-73 Ginger CAR71-CV-GI

COUPE CARPET KIT



This is the good stuff. 1964-1968 are constructed from 80% Rayon 20 % Nylon,

1969-1970 are 100% Nylon. All edges are sewn to prevent unraveling. Drivers side has molded, colored keyed rubber heel and toe pad. All carpet is backed with a heavy 27 ounce jute insulation layer. Also features a precut gearshift hole. Fastbacks include small lower quarter panel sections.

Carpet Kit, Coupe

64 Black CAR64-CP-BK
64 Red CAR64-CP-BR
64 Dark blue CAR64-CP-DB
65-66 Dark teal CAR65-6-CP-DT
65-68 Aqua CAR65-CP-AQ
65-68 Bright blue CAR65-CP-BB
65-68 Black CAR65-CP-BK
65-68 Dark brown CAR65-CP-BN
65-68 Red CAR65-CP-BR
65-68 Dark blue CAR65-CP-DB
65-68 Dark green CAR65-CP-DG
65-68 Dark saddle CAR65-CP-DS
65-68 Emberglow CAR65-CP-EM
65-68 Ivy gold CAR65-CP-IG
65-68 Maroon CAR65-CP-MR
65-68 Nugget gold CAR65-CP-NG
65-68 Saddle CAR65-CP-SA
69-70 Black CAR69-CP-BK
69-70 Dark brown CAR69-CP-BR
69-70 Dark blue CAR69-CP-DB
69-70 Dark green CAR69-CP-DG
69-70 Ginger CAR69-CP-GI
69-70 Maroon CAR69-CP-MR
69-70 Vermillion CAR69-CP-VE
71-73 Black CAR71-CP-BK
71-73 Blue CAR71-CP-BL
71-73 Bright red CAR71-CP-BR
71-73 Dark green CAR71-CP-DG
71-73 Ginger CAR71-CP-GI

WE PROUDLY FEATURE AUTHENTIC MUSTANG REPRODUCTIONS FROM SCOTT DRAKE ENTERPRISES!



FASTBACK CARPET KIT



This is the good stuff. 1964-1968 are constructed from 80% Rayon 20% Nylon, 1969-1970 are 100% Nylon. All edges are

sewn to prevent unraveling. Drivers side has molded, colored keyed rubber heel and toe pad. All carpet is backed with a heavy 27 ounce jute insulation layer. Also features a precut gearshift hole. Fastbacks include small lower quarter panel sections.

Carpet Kit, Fastback

65-68	Aqua	CAR65-FB-AQ
65-68	Bright blue	CAR65-FB-BB
65-68	Black	CAR65-FB-BK
65-68	Dark brown	CAR65-FB-BN
65-68	Bright red	CAR65-FB-BR
65-68	Dark blue	CAR65-FB-DB
65-68	Dark green	CAR65-FB-DG
65-68	Dark saddle	CAR65-FB-DS
65-68	Emberglow	CAR65-FB-EM
65-68	Ivy gold	CAR65-FB-IG
65-68	Maroon	CAR65-FB-MR
65-68	Nugget gold	CAR65-FB-NG
65-68	Saddle	CAR65-FB-SA
69-70	Black	CAR69-FB-BK
69-70	Dark blue	CAR69-FB-DB
69-70	Dark green	CAR69-FB-DG
69-70	Ginger	CAR69-FB-GI
69-70	Maroon	CAR69-FB-MR
70	Vermillion	CAR69-FB-VE
71-73	Black	CAR71-FB-BK
71-73	Blue	CAR71-FB-BL
71-73	Dark green	CAR71-FB-DG
71-73	Ginger	CAR71-FB-GI

ECONOMY CARPET KIT



These are quality molded carpet sets made from 100% nylon, and available at a lower price than our standard carpet kits.

Available for 65-68 coupes, convertibles, and fastbacks.

Carpet Kit, Economy

65-68	CP, black	CAR-65-CP-BK-N
65-68	CV, black	CAR-65-CV-BK-N
65-68	FB, black	CAR-65-FB-BK-N

MACH 1 CARPET KIT



1969 has four rubber inserts just like originals, specify colors. 1970 has 2 rubber inserts.

1971-1973 have two rubber inserts with correct embossed horse.

Carpet Kit, Mach 1

69	Black, w/ black inserts	..	CAR69-M-BK/BK
69	Black, w/ red inserts	...	CAR69-M-BK/RD
70	Black, w/ black inserts	..	CAR70-M-BK/BK
70	Black, w/ gray inserts	..	CAR70-M-BK/GY
70	Blue, w/ blue inserts	CAR70-M-BL/BL
71-73	Black, w/ black inserts	..	CAR71-M-BK/BK
71-73	Black, w/ gray inserts	...	CAR71-M-BK/GR
71-73	Blue, w/ blue inserts	CAR71-M-BL/BL
71-73	Ginger, w/ ginger inserts		CAR71-M-GI/GI

CARPET FLOOR MAT



Aftermarket replacements made by Auto Custom Carpet. Made from the 80/20 blend so this will match 1964-1968

styles. Features rubber backing with anti-slip spikes. All are complete four piece sets, both fronts and two rears.

Floor Mat, Carpet

64-73	Black, no logo	ACC-FM-BK
64-68	Bright blue, no logo	ACC-FM-BB
64-73	Dark blue, no logo	ACC-FM-DB
64-73	Bright red, no logo	ACC-FM-BR
64-73	Ginger, no logo	ACC-FM-GI
64-73	Ivy gold, no logo	ACC-FM-IG
64-73	Maroon, no logo	ACC-FM-MR
65-68	Turquoise, no logo	ACC-FM-TQ

CUSTOM FIT, MUSTANG CARPET

FLOOR MAT



The same quality as our embroidered floor mats. Features a full-size fit.

Available for coupe/fastback and convertible.

Floor Mat, Custom Fit, Mustang Carpet

64-73	CP/FB, aqua*	ACC-FM-CPFB-AQ
64-73	CP/FB, bright blue*	ACC-FM-CPFB-BB
64-73	CP/FB, black*	ACC-FM-CPFB-BK
64-73	CP/FB, bright red*	ACC-FM-CPFB-BR
64-73	CP/FB, dark blue*	ACC-FM-CPFB-DB
64-73	CP/FB, emberglow*	...	ACC-FM-CPFB-EM
64-73	CP/FB, ginger*	ACC-FM-CPFB-GI
64-73	CP/FB, green*	ACC-FM-CPFB-GR
64-73	CP/FB, ivy gold*	ACC-FM-CPFB-IG
64-73	CP/FB, maroon*	ACC-FM-CPFB-MR
64-73	CV, aqua*	ACC-FM-CV-AQ
64-73	CV, bright blue*	ACC-FM-CV-BB
64-73	CV, black*	ACC-FM-CV-BK
64-73	CV, bright red*	ACC-FM-CV-BR
64-73	CV, dark blue*	ACC-FM-CV-DB
64-73	CV, ivy gold*	ACC-FM-CV-IG
64-73	CV, maroon*	ACC-FM-CV-MR

EMBROIDERED, COBRA CARPET

FLOOR MAT



The Classic Cobra logo in red, white & blue, embroidered on black carpeted floor mats. Carpet is 80/20 blend to match 1964-68 carpets from ACC. Features rubber backing with anti-slip spikes. Logo is featured on front mats.

Floor Mat, Embroidered, Cobra Carpet



64-73: Black, classic Cobra⁵
ACC-FM-COBRA-BK



64-73: Black/silver, Cobra snake⁶
ACC-FM-SNAKE-BK

SHOP WITH CONFIDENCE! WE OFFER SUPERIOR-QUALITY PARTS FOR ALL YOUR MUSTANG RESTORATION NEEDS.

EMBROIDERED, MUSTANG CARPET FLOOR MAT



Made by Auto Custom Carpet out of the same 80/20 blend as our 1964 - 1968 carpet

for a perfect match. They feature a high quality embroidered running horse logo on front mats and a rubber backing with anti-slip spikes. Set includes two front mats and two rear mats.

Floor Mat, Embroidered, Mustang Carpet

- 64-68 Aqua * ACC-FM-EMB-AQ
- 64-68 Bright blue * ACC-FM-EMB-BB
- 64-73 Black * ACC-FM-EMB-BK
- 64-73 Dark brown * ACC-FM-EMB-BN
- 64-73 Bright red * ACC-FM-EMB-BR
- 64-73 Dark blue * ACC-FM-EMB-DB
- 64-73 Dark green * ACC-FM-EMB-DG
- 64-73 Emberglow * ACC-FM-EMB-EM
- 64-73 Ginger * ACC-FM-EMB-GI
- 64-73 Ivy gold * ACC-FM-EMB-IG
- 64-73 Maroon * ACC-FM-EMB-MR
- 64-73 Saddle * ACC-FM-EMB-SA

PONY FLOOR MATS



These are exact copies of an original Ford accessory. Molded in colored PVC

these mats also feature spikes on the backside to reduce sliding. Set includes two front and two rear mats. Note: we also have a limited supply of front only, rubber mat sets (C5ZZ-6513086-FO) available, order now before supplies run out.

Floor Mats, Pony

- 64-73 Black, 4 piece set * C5ZZ-6513086-BK
- 64-73 Blue, 4 piece set * C5ZZ-6513086-BL
- 64-73 Brown, 4 piece set * C5ZZ-6513086-BN
- 64-73 Dark red, 4 piece set * C5ZZ-6513086-DR
- 64-73 Red, 4 piece set * C5ZZ-6513086-RD
- 64-73 Green, 4 piece set C5ZZ-6513086-GR
- 64-73 Black, rubber, front mats only * C5ZZ-6513086-FO

FASTBACK FOLD DOWN SEAT CARPET







Made from the original 80/20 blend or 100% Nylon carpeting. Cut to fit.

Fold Down Seat Carpet, Fastback

- 65-68 Bright blue, 80/20 FD-65-BB
- 65-68 Black, 80/20 FD-65-BK
- 65-68 Black, 100% nylon FD-65-BK-N
- 65-68 Dark brown FD-65-BN
- 65-68 Bright red, 80/20 FD-65-BR
- 65-68 Dark blue, 80/20 FD-65-DB
- 65-68 Dark green, 80/20 FD-65-DG
- 65-68 Dark saddle, 80/20 FD-65-DS
- 65-68 Emberglow, 80/20 FD-65-EM
- 65-68 Ivy gold, 80/20 FD-65-IG
- 65-68 Nugget gold, 80/20 FD-65-NG
- 65-68 Saddle, 80/20 FD-65-SA
- 66-68 Aqua, 80/20 FD-65-AQ
- 66-68 Maroon, 80/20 FD-65-MR
- 69-70 Black, 100% nylon FD-69-BK
- 69-70 Dark blue, 100% nylon FD-69-DB
- 69-70 Ginger, 100% nylon FD-69-GI
- 69-70 Maroon, 100% nylon FD-69-MR
- 69-70 Vermillion, 100% nylon FD-69-VE
- 71-73 Black, 100% nylon FD-71-BK
- 71-73 Dark blue, 100% nylon FD-71-DB
- 71-73 Dark green, 100% nylon FD-71-DG
- 71-73 Ginger, 100% nylon FD-71-GI
- 71-73 Vermillion, 100% nylon FD-71-VE

CARPET UNDERLAYMENT KIT

Kits include heavy duty die cut E.V.A. type rubber pad which aids against carpet ware, especially around sharp contoured floor areas.

- Underlayment Kit, Carpet**
-  64-73: CP/FB, front & rear wells
UL-1
 -  64-73: CV, front & rear wells
UL-3
 -  64-73: Transmission hump
UL-4
 -  65-68: Trunk
UL-5

CONSOLE AND OVERHEAD CONSOLE

CRUISER CONSOLE



These consoles are AWESOME! The cruiser console fits perfectly between the front seats

and over the gear shifter (manual or auto). Same quality as the original Humphugger plus added features, coin tray, felt-lined holder for eyeglasses or cell phone and two large size cup holders.

Console, Cruiser

- 64-73 Black, w/out factory console CC-BK
- 64-73 Dark blue, w/out factory console .. CC-DB
- 64-73 Dark red, w/out factory console CC-DR
- 64-73 Light blue, w/out factory console .. CC-LB
- 64-73 Bright red, w/out factory console .. CC-RD
- 64-73 Ivy gold, w/out factory console CC-IG
- 64-73 Parchment, w/out factory console CC-PR
- 64-73 White, w/out factory console CC-WT
- 64-73 Black, long, w/ factory console SCL-BK
- 64-73 Dark blue, long, w/ factory console ... SCL-DB
- 64-73 Light blue, long, w/ factory console .. SCL-LB
- 64-73 Bright red, long, w/ factory console .. SCL-RD
- 64-73 Dark red, long, w/ factory console SCL-DR

HUMP HUGGER CONSOLE



These consoles are designed with quality in mind. All consoles are constructed using automotive grade vinyl and are double

stitched with commercial grade nylon thread, resistant to heat and sun. All hinges are corrosion resistant nickel plated for longevity.

Console, Hump Hugger

- 64-73 Black HH-BK
- 64-73 Black leather suede HH-BK-L
- 64-73 Dark blue HH-DB
- 64-73 Dark red HH-DR
- 64-73 Emberglo HH-EM
- 64-73 Ginger HH-GI
- 64-73 Ivy gold HH-IG
- 64-73 Light blue HH-LB
- 64-73 Nugget gold HH-NG
- 64-73 Palomino HH-PA
- 64-73 Parchment HH-PR
- 64-73 Bright red HH-RD
- 64-73 Saddle HH-SA
- 64-73 Turquoise HH-TQ
- 64-73 White HH-WT

Interior

WE PROUDLY FEATURE AUTHENTIC MUSTANG REPRODUCTIONS FROM SCOTT DRAKE ENTERPRISES!



PLUG & CHUG CONSOLE



The 64-66 Plug & Chug inserts into the dash in place of an ashtray. The 68-73 Plug & Chug goes into the seat belt holder of the center console.

Console, Plug & Chug

64-66 Black	PC-BK
64-66 White	PC-WT
68-69 Black	PC-BK-68
71-73 Black	PC-BK-71

SADDLE CONSOLE



Designed to fit over the top of 1964-1967 consoles. All consoles are constructed using automotive grade vinyl and are double

stitched with commercial grade nylon thread, resistant to heat and sun. All hinges are corrosion resistant nickel plated for longevity.

Console, Saddle

64-65 Palomino	SC-PA
64-65 Bright red	SC-RD
64-66 Emborglo	SC-EM
64-66 White	SC-WT
64-67 Black	SC-BK
64-67 Dark blue	SC-DB
64-73 Black leather	SC-BK-L
66-67 Dark red	SC-DR
66-67 Ivy gold	SC-IG
66-67 Light blue	SC-LB
66-67 Parchment	SC-PR
66-67 Turquoise	SC-TQ

CONSOLE ASH TRAY LID



Our lid makes replacing those broken lids easy. Features correct texture and color.

Console Ash Tray Lid

69-70	C9ZZ-6504814
-------------	--------------

CONSOLE ASH TRAY RECEPTICLE



A beautiful reproduction of the ash tray that fits in the back of the center console.

Console Ash Tray Recepticle

64-66	C5ZZ-65048A42-A
-------------	-----------------

COMPLETE CONSOLE ASSEMBLY

Wow! What a nice part, never thought a reproduction would ever be made. Plastic injection black housing just as original, not a substandard fiberglass version. Includes: Radio bezel, all upper brushed chrome plates, ash tray, floor convenience lamp and wiring harness.

Console Assembly, 67 Complete



67: Automatic, will also fit 68, but not concours for 68
C7ZZ-65045A36-K



67: Manual, will also fit 68, but not concours for 68
C7ZZ-65045A36-M

69-70 COMPLETE CONSOLE ASSEMBLY

This beautiful reproduction includes main housing, both ash trays, cigarette lighter assembly, main top plate, compartment box and rest pad hinge. Arm rest pad and console shift plate are sold separately.

Console Assembly, 69-70 Complete



69-70
C9ZZ-6504536

CONSOLE HOUSING

A beautiful reproduction. Ready for your lights and panel. Back side conveniently marked for trimming on convertible and AC applications.

Console Housing



64-66
C5ZZ-65045A36-A



69-70: Upper housing, Shelby
C9ZZ-63044D90-A

CONSOLE COMPARTMENT BOX



This is the compartment box, it includes the chrome trim for cigar lighter.

Console Compartment Box

69	C9ZZ-6506010
----------	--------------

CONSOLE DOOR SPRING



Correct springs for console doors. Plated to prevent corrosion.

Console Door Spring

64-66	C5ZZ-6506040/1A
-------------	-----------------

CONSOLE END CAP

Pressure die cast zinc with show car quality chrome. Used on air conditioned cars only.

Console End Cap



64-65: Concours for 64-65, but will also fit 66
C5ZZ-65044D38-A



66: Concours
C6ZZ-65044D38-A

CONSOLE FLIP OPEN DOOR



Beautiful chrome and black flip open console door, comes with door springs. Nice reproduction.

Console Flip Open Door

65-66	C5ZZ-6506024-D
-------------	----------------

CONSOLE FRONT PANEL



The front panel for the glovebox in the console.

Console Front Panel

65-66	C5ZZ-6306021
-------------	--------------

CONSOLE INSERT



These are complete inserts for our Deluxe Console Plates. Plastic chrome with wood-grain vinyl, ready to install!

Console Insert

69 Teak	C9ZZ-6504567-CT
69 Walnut	C9ZZ-6504567-CW
70 Teak	D0ZZ-6504567-CT
70 Walnut	D0ZZ-6504567-CW

CONSOLE INTERNAL HARNESS



This harness supplies power to the console. Comes from under dash harness and runs underneath carpet, exits at carpet shifter hole location.

Console Internal Harness
64-66 Dash to consoleC5ZZ-13B712-A

CONSOLE LAMP LENS



Fits on the rear of the console. Original white plastic color.

Console Lamp Lens
64-66C5ZZ-13734-A
67-68C7Z-13783-A

CONSOLE MOUNTING BRACKET

Stamped steel design painted black, made exactly as original. Mounting hardware included.

Console Mounting Bracket



64-66: Front
C5ZZ-65045B32



67-68: Overhead, rear, FB
C7ZB-63519B52



67-68: Overhead, front
C7ZB-65519B46-A

CONSOLE MOUNTING KIT



Very convenient kit to easily mount your console. Includes all correct screws needed.

Console Mounting Kit
64-66 16 pcs. CMK-656

CONSOLE OVERLAY



Console Overlay
64-66 Wood vinyl C5ZZ-6504567-W
67 alum. mylar, auto. C7Z-6504567-A
69 Wood vinyl, w/ seatbeltsWG-153-V
69-70 Wood vinyl, w/out seatbelts ..WG-154-V

CONSOLE PAD

Correct urethane molded and textured black vinyl pad. Easy to replace those cracked and worn originals.

Console Pad



69-70: std.
C9ZZ-6506024-BK



70: dlx.
D0ZZ-6506024-BK



71-73: Black only
D1ZZ-6506024-A

CONSOLE REAR LIGHT ASSEMBLY



Good quality reproduction part, features white plastic lens and pressure die cast body with excellent chrome on

the bezel.

Console Rear Light Assembly

65-66C5ZZ-13707-A
67-68C7Z-13707-A

CONSOLE RESTORATION KIT



Makes restoring a console easy and convenient. Kit includes shift dial, shift slide, console lens with screws and all

hardware necessary to mount console to the floor.

Console Restoration Kit

64-66 KIT-TRN-3

CONSOLE ROLL UP DOOR

Stainless steel flexible slats just like original, chrome plated knob.

Console Roll Up Door



67
C7Z-6506024-A

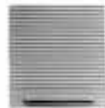

68
C8Z-6506024-A

CONSOLE SHIFT PLATE

Nice reproductions of excellent quality.
Console Shift Plate



64-66: auto, chrome/black
C5ZZ-7C309-A



64-66: manual
C5ZZ-7C309-M



67: auto, chrome
C7Z-7C309-A



67: manual, chrome
C7Z-7C309-M



67-68: auto, brushed alum.
C7Z-7D443-P



69: dlx., auto.
C9ZZ-6504567-AD



69: std., auto.
C9ZZ-6504567-AS



69: dlx., 4 speed
C9ZZ-6504567-MD



69: std., 4 speed
C9ZZ-6504567-MS



70: dlx., auto.
D0ZZ-6504567-AD



70: std., auto.
D0ZZ-6504567-AS



70: dlx., 4 speed
D0ZZ-6504567-MD



70: std., 4 speed
D0ZZ-6504567-MS

WE PROUDLY FEATURE AUTHENTIC MUSTANG REPRODUCTIONS FROM SCOTT DRAKE ENTERPRISES!



CONSOLE TOP PLATE



Die cast construction, chrome plated and recessed area painted black.

Console Top Plate
64-66 C5ZZ-6504567-C

CONSOLE UPPER PLATE



This is the upper panel that the shifter chrome trim attaches to, comes with the metal retainers.

Console Upper Plate
69-70 C9ZZ-6304490

OVERHEAD CONSOLE ASSEMBLY



A beautiful reproduction of a rare option. The console base is made of vinyl and urethane with exact details. We have installed our maplight switch and light housing with our beautiful chrome bezels. Includes wiring harness and mounting screws. Mounting brackets available separately.

Overhead Console Assembly
67 FB, black C7ZZ-63519A58BK
67 FB, blue C7ZZ-63519A58BL
67 FB, ivy gold C7ZZ-63519A58IG
67 FB, parchment C7ZZ-63519A58PR
67 FB, red C7ZZ-63519A58RD
67 CP, black C7ZZ-65519A58BK
67 CP, blue C7ZZ-65519A58BL
67 CP, ivy gold C7ZZ-65519A58IG
67 CP, parchment C7ZZ-65519A58PR
67 CP, red C7ZZ-65519A58RD

OVERHEAD CONSOLE HOUSING



Overhead Console Housing
67 FB, black OHC-63519A58-BK
67 FB, blue OHC-63519A58-BL
67 FB, ivy gold OHC-63519A58-IG
67 FB, parchment OHC-63519A58-PR
67 FB, red OHC-63519A58-RD
67 CP, black OHC-65519A58-BK
67 CP, blue OHC-65519A58-BL
67 CP, ivy gold OHC-65519A58-IG
67 CP, parchment OHC-65519A58-PR
67 CP, red OHC-65519A58-RD

OVERHEAD CONSOLE MAP LIGHT



Die-cast construction with a quality chrome finish. Another excellent reproduction. Includes clear lenses.

Overhead Console Map Light
67-68 C7ZZ-13788-A

OVERHEAD CONSOLE OVERLAY



Wood grain vinyl for the Overhead Console panel

Overhead Console Overlay
68 CP WG-151-V
68 FB WG-152-V

OVERHEAD CONSOLE PANEL



Features a stamped aluminum, line-grain finish like the originals. Not a cheap vinyl decal.

Overhead Console Panel
67 FB C7ZZ-63519A58AL
67 CP C7ZZ-65519A58AL

DASH

DASH PANEL ASSEMBLY



Complete metal stamped dash assembly.
Dash Panel Assembly
67-68 C7ZZ-6504320-A

CLOCK KNOB AND SCREW SET



Our Clock adjusting knob features great detail and a nice chrome finish. The set screw is threaded for the original clock stem.

Clock Knob and Screw Set
67-68 C7ZZ-15032-A

DASH MOLDING CLIP KIT



Dash Molding Clip Kit includes chrome screws and the special spring clips that secure the trim moldings to the dash. 10 pieces

Dash Molding Clip Kit
64-65 C4DZ-6404561-K

DASH PANEL AC VENT INSERT



Our brushed aluminum inserts match our other 67 Deluxe panels. Includes 4 pieces. Does not include adhesive.

Dash Panel AC Vent Insert
67 C7ZZ-6504410-AC

HEATER CONTROL PLATE



Matches our other interior woodgrain and brushed aluminum pieces. Adhesive not included.

Heater Control Plate - Woodgrain
67 Aluminum w/out AC . C7ZZ-6504410-HC
68 Woodgrain w/out AC . C8ZZ-6504410-HC

DELUXE DASH PANEL

Our standard dash panels are quality injection molded plastic, chrome plated. Available without inserts so you can add your own, or with inserts already installed! Our aluminum inserts are real brushed aluminum, and our woodgrain inserts are vinyl with metal backing to prevent shrinking. For Deluxe interiors.

Dash Panel, Deluxe



67: 3 piece set w/ alum. inserts
C7ZZ-6504410-KR



67: Upper w/ alum. insert
C7ZZ-65044A90AR



67-68: Lower w/out insert
C7ZZ-65044A10-C



67-68: Upper w/out insert
C7ZZ-65044A90-A



67-68: Center w/out insert
C7ZZ-6504774-A



68: 3 piece set w/ metal backed woodgrain inserts
C8ZZ-6504410-KR



68: w/ metal backed woodgrain inserts, for cars w/ AC
C8ZZ-6504410-AC

Interior

STANDARD DASH PANEL

Our standard dash panels are quality injection molded plastic, chrome plated and then screened black. For standard interiors.

Dash Panel, Standard



67-68: 3 piece set
C7Z-6504410-K



67-68: Lower
C7Z-65044A10-D



67-68: Upper
C7Z-65044A90-B



67-68: Center
C7Z-6504774-B

DASH PANEL INSERT

These vinyl inserts are made to be installed on dash and instrument panel. Adhesive backed.

Dash Panel Insert



68: Metal-backed woodgrain, 4 piece set
WG-102-M



68: Woodgrain, 7 piece set
WG-128-V



68: Woodgrain, 9 piece set
WG-129-V

DASH PANEL APPLIQUE

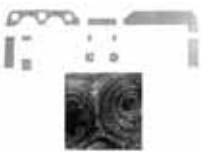

Real wood and carbon fiber trim from Distinctive Industries and Scott Drake is one of the most dramatic enhancements to any

classic Mustang interior. A unique look that adds luster and richness. Limited supply.

Dash Panel Applique

64-65	std., carbon fiber, 11 pieceDA-65-S-C
64-65	std., rosewood, 11 pieceDA-65-S-R
65-66	GT, burlwood, 7 pieceDA-65-P-B
65-66	GT, carbon fiber, 7 pieceDA-65-P-C
65-66	GT, rosewood, 7 pieceDA-65-P-R
66	std., burlwood, 11 pieceDA-66-S-B
66	std., carbon fiber, 11 pieceDA-66-S-C
66	std., rosewood, 11 pieceDA-66-S-R
67	dlx., burlwood, 11 pieceDA-67-D-B
67	dlx., carbon fiber, 11 pieceDA-67-D-C
67	dlx., rosewood, 11 pieceDA-67-D-R
67	std., burlwood, 11 pieceDA-67-S-B
67	std., carbon fiber, 11 pieceDA-67-S-C
67	std., rosewood, 11 pieceDA-67-S-R
68	dlx., burlwood, 11 pieceDA-68-D-B
68	dlx., carbon fiber, 11 pieceDA-68-D-C
68	dlx., rosewood, 11 pieceDA-68-D-R
68	std., burlwood, 11 pieceDA-68-S-B
68	std., carbon fiber, 11 pieceDA-68-S-C
68	std., rosewood, 11 pieceDA-68-S-R

DASH PADS

MADE FROM ORIGINAL FORD TOOLING

Scott Drake Mustang and Universal Urethane have gone to great lengths to make their dash pads the best on the market. We start by using Ford's Original Tooling. Next we went to Ford's original supplier of vinyl for exact grain and texture. These dash pads are the finest available and easiest to install.



1964-65

C5ZZ-6504290-BK†	65	Black
C5ZZ-6504290-BL†	64-65	Blue
C5ZZ-6504290-BR†	65	Bright red
C5ZZ-6504290-NL†	64-65	Neutral



1966

C6ZZ-6504290-BK†	66	Black
C6ZZ-6504290-BL†	66	Blue
C6ZZ-6504290-BR†	66	Bright red
C6ZZ-6504290-DR†	66	Dark red
C6ZZ-6504290-IG†	66	Ivy gold
C6ZZ-6504290-NL†	66	Neutral



1967-68

Sorry, Original Ford Tooling Dash Pads not available for 1967-68

C9ZZ-6504282AIA†	69-70	Black, w/out AC
C9ZZ-6504282BIA†	69-70	Black, w/ AC
C9ZZ-6504282WAC†	69-70	Neutral, w/ AC
C9ZZ-6504282WNA†	69-70	Neutral, w/out AC



1969-70

D1ZZ-6504290-BK†	71-73	Black
D1ZZ-6504290-BL†	71-73	Blue
D1ZZ-6504290-G†	71-73	Ginger



1971-73

REPRODUCTION DASH PAD

A nice reproduction at a lower price. Not made from original Ford tooling.

Dash Pad, Reproduction

64-65	BlackC5ZZ-6504290BKR
64-65	BlueC5ZZ-6504290BRL
64-65	RedC5ZZ-6504290BRR
66	BlackC6ZZ-6504290BKR
66	BlueC6ZZ-6504290BRL
66	Dark redC6ZZ-6504290DRR
67-68	AquaC7ZZ-6504290-AQ
67-68	BlackC7ZZ-6504290-BK
67-68	BlueC7ZZ-6504290-BL
67-68	Ivy goldC7ZZ-6504290-IG
67-68	RedC7ZZ-6504290-RD
71-73	BlackD1ZZ-6504290BKR
71-73	BlueD1ZZ-6504290BRL
71-73	GingerD1ZZ-6504290GIR

PLASTIC DASH COVER



Molded plastic dash covers that appear to be an original padded dash. Slips over the original padded dash panel for a nifty cure

for splits and tears. Completely blocks UV light and the drying effects it causes on vinyl covering on padded dashes.

Dash Cover, Plastic

64-65C5ZZ-6504290-DC
66C6ZZ-6504290-DC
67-68C7ZZ-6504290-DC
69-70	w/out ACC9ZZ-6504290-DC
69-70	w/ ACC9ZZ-6504290DCA
71-73D1ZZ-6504290-DC

WE PROUDLY FEATURE AUTHENTIC MUSTANG REPRODUCTIONS FROM SCOTT DRAKE ENTERPRISES!



DASH PANEL BEZEL



This is the section above the glove box door.

Dash Panel Bezel

71-73 Black, RH D1ZZ-10838-RH

DASH PANEL REPAIR PLATE



For that hacked radio installation, this panel provides a new dashboard section for

installation of a stock radio and an original look. Can be welded into position. Designed to fit under dash pad.

Dash Panel Repair Plate

65-66 CSZZ-6504360-PP

DASH PANEL EMBLEM



Dash Panel Emblem

67: "Shelby GT350" grille, dash or deck⁶

S7MS-16098-C

67: "Shelby GT500" grille, dash or deck⁶

S7MS-16098-D

67-68: Running horse, red & silver, very

small 7/8"x3/8", adhesive backed*

C7ZZ-65044A90-E

67-68: Running horse tribar

emblem w/ base, for dlx. int.*

C7ZZ-65044A90EP

67-68: Running horse tribar

emblem w/out base, for dlx. int.*

C7ZZ-65044A90-M

67-68: Running horse base only,

for dlx. int.

C7ZZ-65044A90-P

68: GT 500⁶

S8MS-6304460-C

68: GT 350⁶

S8MS-6304460-D

68: Cobra Jet⁶

S8MS-6304460-E

69-70: Mach 1*

C9ZZ-6304460-A

69-70: Mustang script

C9ZZ-6304460-B

69-70: Cobra GT 350*

S9MS-6304460-A

69-70: Cobra Jet GT 500*

S9MS-6304460-B

LOWER INSTRUMENT PANEL PAD



Molded in urethane and made with exact detail of the original. Available in assorted colors.

Lower Instrument Panel Pad

67-68 Black C7ZZ-6504292-BK

67-68 Blue C7ZZ-6504292-BL

67-68 Ivy Gold C7ZZ-6504292-IG

67-68 Parchment C7ZZ-6504292-PR

67-68 Red C7ZZ-6504292-RD

67-68 Aqua/turquoise C7ZZ-6504292-TQ

PARKING BRAKE HANDLE

High quality injection molded parts, mounting lock pin and allen set screw included. Excellent detail in a reproduction part. Black plastic. New improved metal insert. Thicker than original.

Parking Brake Handle



64-66

CODZ-2760-B



67-68

C7ZZ-2760-B

RADIO AND HEATER BEZEL INSERT



Wood vinyl covering for radio and heater bezels.

Radio and Heater Bezel Insert

69-70 Wood vinyl WG-130-V

CENTER DASH RADIO MOLDING



ABS trim pieces for each side of the radio.

Radio Molding, Center Dash

69-70 C9ZZ-6504472/3

DOOR SILLS

LIGHTED SILL PLATE

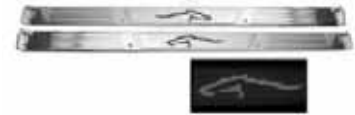

These sill plates are constructed of 304 stainless steel, not lightweight aluminum. We also gave it a bright, polished finish, and added brushed GT type stripes for a retro look that will keep it looking great for years. Additionally featured is a custom logo with a cool blue luminescent light that glows when the doors are opened. In daylight or at night, our lighted sill plates will turn heads. Simple installation makes this a "must have" part for your Mustang.

Sill Plate, Lighted

64-68 CP/FB, red CSZZ-6513208-RD

64-68 CP/FB, blue CSZZ-6513208-HL

64-68 CV, blue CSZZ-7613208-HL

69-70 All, blue C9ZZ-6513208-HL

ORIGINAL FORD TOOLING SILL



Made by original Ford supplier. Concourse quality. Perfect fit. Heavy gauge aluminum. Emblem not included.

Sill Plate, Original Ford Tooling

64-68 CP/FB CSZZ-6513208-BP

64-68 CV CSZZ-7613208

REPRODUCTION SILL PLATE



'64-'68

New improved stampings, which are thicker than previous reproductions. These new stampings are stronger and stiffer. Polished aluminum. Emblem not included.

Sill Plate, Reproduction

64-68 CP/FB CSZZ-6513208-B

64-68 CV CSZZ-7613208-C

69-70 All C9ZZ-6513208-A

71-73 All D1ZZ-6513208-A

STAINLESS STEEL SILL PLATE



A Scott Drake exclusive! These plates are stamped to look like original scuff plates but feature highly-polished stainless steel. These are heavy-gauge scuff plates and will not dent or scratch like other aluminum versions. Our plates also feature slotted mounting holes for quick and easy installation.

Sill Plate, Stainless Steel

64-68 CV CSZZ-7613208-SS

65-68 CP/FB CSZZ-6513208-SS

Interior

STAINLESS STEEL ACCESSORY SILL PLATE



A Ford accessory designed to protect paint on rocker. Stainless steel construction. **Sill Plate, Stainless Steel Accessory**
 64-68 CP/FB C5ZZ-6513242-A
 69-70 All C9ZZ-6513242-A

SILL PLATE EMBLEM

*  This is the aluminum emblem which mounts on the center of all scuff plates. Features raised script like original, adhesive backed and protective coating.
Sill Plate Emblem

 64-66: Black, Ford logo*
 C5ZZ-6513208-T

 65-66: Shelby®
 S1MS-6513208-T

 67-73: Blue, Ford logo*
 C7ZZ-6513208-T

 68-73: Blue, Ford logo*
 C8ZZ-6513208-T

SILL PLATE SCREW

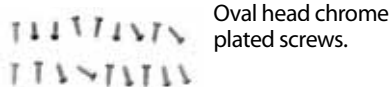

Oval head chrome plated screws.

Sill Plate Screw
 64-68 Set of 18 376290-SK
 64-70 Bulk 376290-S

DOORS

See "Door Parts" section earlier in this catalog

FASTBACK

FASTBACK FOLD DOWN SEAT LATCH



Complete latch includes main body, chrome sliding latch, chrome knob and rubber bumper.

Fold Down Seat Latch, Fastback
 65 RH C5ZZ-6361382-A
 66 LH C6ZZ-6361382-A
 67-70 RH C7ZZ-6361382-A
 67-70 LH C7ZZ-6361383-A

FASTBACK FOLD DOWN SEAT MOLDING



Stamped steel construction and chrome plated. Complete kit which includes hinge.

Fold Down Seat Molding, Fastback
 65-68 C5ZZ-63130A18-K
 69-70 C9ZZ-63130A18-K

FASTBACK INTERIOR QUARTER TRIM

These are just like originals.
Quarter Trim, Fastback Interior

 67-68: Full set
 C7ZZ6331144/83K

 69-70: Pair, orig. plastic injection textured surface
 C9ZZ-63311A92-A

QUARTER PANEL TRIM CAP

These are excellent reproductions. Sold in pairs only. 65-66 version is made from polished stainless. 69-70 version is black plastic with correct texture.
Quarter Panel Trim Cap

 65-66: CP, Pony int.
 C5ZZ-6531490/1

 69-70: FB
 C9ZZ-6331490/1A

INTERIOR QUARTER PANEL

Made from sturdy black ABS plastic with embossed grain pattern paint to match or cover quarter panel vinyl trim.
Interior Quarter Panel

 65-66: FB, Fiberglass
 C5ZZ-6331486/7A

 67-68: FB, Fiberglass
 C7ZZ-6331486/7A

 67-68: FB, ABS inc. steel reinforcement & courtesy lights
 C7ZZ-6331486/7-K

No Photo Available 69-70: FB, ABS Plastic
 C9ZZ-6331486/7P

FASTBACK REAR SEAT GUIDE



Black injection molded plastic just like the originals. This part is a fast seller, as most originals are damaged or missing.

Rear Seat Guide, Fastback
 65-66 C5ZZ-63613B28-B

FASTBACK REAR SEAT HARDWARE



Kit includes all rests, bumpers and guides for a complete job. Ten pieces in each kit.

Rear Seat Hardware, Fastback
 65 Early C5ZZ-6360575-K
 65-66 C6ZZ-6360575-K

FASTBACK REAR SEAT LATCH COVER PLATE



Textured like originals. Paint to match.

Rear Seat Latch Cover Plate, Fastback
 65 C5ZZ-63613B26-A
 66 C6ZZ-63613B26-A
 67-68 fixed rear seat C7ZZ-63613B26/7
 67-68 folddown, RH C7ZZ-63613B26-A
 67-68 folddown, LH C7ZZ-63613B27-A

FASTBACK REAR SEAT LATCH KNOB

We offer these 100% correct copies of the original parts for the discriminating Mustang owner. Made from machined steel, then heavily chrome plated.
Rear Seat Latch Knob, Fastback

 65-66
 C5ZZ-6362418-B
 67-70
 C7ZZ-6362418-B

FASTBACK REAR SEAT SUPPORT

Chrome plated heavy gauge steel. Supports seat when raised.
Rear Seat Support, Fastback

 65
 C5ZZ-6360575-A
 65-70
 C6ZZ-6360575-A

Interior

WE PROUDLY FEATURE AUTHENTIC MUSTANG REPRODUCTIONS FROM SCOTT DRAKE ENTERPRISES!



FASTBACK REAR TRIM CENTER CAP



Stamped steel trim cap used to attach narrow fastback interior moldings.

Rear Trim Center Cap, Fastback
65-66 C5Z-63291C12-A

REAR SPORT DECK BRACKET



The brackets that secure the rear section of the sport deck to the car.

Sport Deck Bracket, Rear
65-70 C5Z-63424A78-A

FASTBACK TRAP DOOR



This fastback trap door panel is made of original gauge sheet metal and finished with the correct

embossed texture. Painted satin black.
Trap Door, Fastback
65-66 C5Z-6345728-A
67-68 M3661
69-70 C9Z-6345728-A

FASTBACK TRAP DOOR HINGE



Exact detail of the original hinges. Painted black. Ready to install.

Trap Door Hinge, Fastback
67-70 C7B-6345702

FASTBACK TRAP DOOR LATCH



Hold trap door in place. Galvanized to prevent rust.

Trap Door Latch, Fastback
65-68 C5Z-6345704-A
69-70 C7Z-6345704-A

FASTBACK TRAP DOOR LATCH CATCH



The catch to secure the trap door latch.

Trap Door Latch Catch, Fastback
65-70 C5Z-63605A44-A

TRAP DOOR PROP ROD

This part allows you to easily prop open the trap door and hold it in the open position.



Trap Door Prop Rod
67-68
C7Z-6345734-A
69-70
C9Z-6345734-A

UPPER REAR TRIM PANEL

This part is commonly sun damaged. Also, required when converting over to a fold-down car. 69-70 LH and RH corner sections will be available early 2008 under part # C9ZZ-6331222/3

Upper Rear Trim Panel



67-68: 5 piece set
C7Z-63311123-K



69-70: Side panels
C9Z-633112/3-A



69-70: Middle upper
C9Z-63424A68-A

UPPER REAR TRIM PANEL BRACKETS



These brackets are required when adding a fold-down seat option to a non fold-down car. Mounting screws not included.

Upper Rear Trim Panel Brackets
69-70 C7S-6342468-B

FASTBACK INTERIOR VENT GRILL



This hot new product is made from ABS plastic so you will never have to worry about the pocking associated with the

originals. They are beautifully chrome plated with the recessed areas painted black to look like the originals. Cleverly designed to install with small screws from the backside, for simple installation. Sold as a pair with mounting screws included.

Vent Grill, Fastback Interior
67-68 C7Z-6331067-VG

FASTBACK VENT SLIDE

A beautiful reproduction of a commonly pitted part. Our slides are made of zinc die-cast, and finished with highly polished chrome. Mounting hardware included.



Vent Slide, Fastback
65-66
C5Z-63278C20/1
67-68
C7Z-63278C48/9

FASTBACK VENT SLIDE BEZEL

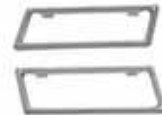

Beautifully chromed stamped steel bezels to replace those nasty originals.

Vent Slide Bezel, Fastback
65-66 C5Z-6331002/3

FASTBACK VENTED QUARTER PANEL TRIM



A beautiful reproduction, these panels are black ABS plastic with shiny chrome grilles for inner quarter trim.

Vented Quarter Panel Trim, Fastback
67-68 Black C7Z-63310A06/7

QUARTER PANEL WINDOW HANDLE



A nice reproduction. Die cast construction with good chrome plating. Hardware included.

Quarter Panel Window Handle
69-70 FB C9Z-6330204/52

GLOVE BOX

GLOVE BOX



1964-1966 & 1971-1973 Precision die cut black chipboard construction just as originals. 1967-1968 Plastic injection.

Glove Box
64-66 Black, chipboard w/ lens . C5Z-6506010-A
64-66 Black, flocked C5Z-6506010-FB
64-66 Gray, flocked C5Z-6506010-FG
66 Black, chipboard, concours ... C6Z-6506010-A
67-68 Black, plastic C7Z-6506010-A
71-73 Black, chipboard, w/out AC ..D1Z-6506010-A
71-73 Black, chipboard, w/ AC ..D1Z-6506010-B

GLOVE BOX BUTTON BEZEL



Commonly missing.
Made of stainless steel.

Glove Box Button Bezel
67-72C60B-62060A12

GLOVE BOX DECAL



This decal came installed on the inside of the glove box door and charted the tire information.

Glove Box Decal
66 *DF-19
67-68 *DF-282

GLOVE BOX DOOR



Excellent reproduction parts, pressure die cast zinc with show car chrome and a correct horse emblem. These are chromed much better than others.

Glove Box Door
64-65: std., black, w/ emblem*
C5ZZ-6506024-A
65: GT, std., black, w/ emblem*
C5ZZ-6506024-B
65-66: dlx., woodgrain, w/ emblem*
C5ZZ-6506024-C
66: std., black, w/ emblem*
C6ZZ-6506024-A

GLOVE BOX DOOR INSERTS



A nice wood applique to replace that worn, cracked or faded surface on 1965

and 1966 Pony glove box doors. See our Instrument Panel section, later in this catalog, for matching instrument panel inserts.

Glove Box Door Inserts
65-66 Woodgrain, metal backedC5ZZ-65060A24
65-66 Woodgrain, vinyl WG-125-V

GLOVE BOX LAMP



Correct wire pigtail.
Bulb included. New improved tooling.

Glove Box Lamp
64-68C5ZZ-14413-A

GLOVE BOX DOOR CABLE



Cable with correct ends and mounting screws.
Supports glove box door when opened.

Glove Box Door Cable
65-66C5ZZ-65060A08-A

GLOVE BOX EMBLEM



Pressure die cast, excellent reproductions. Perfect chrome, stripes are painted correct colors.

Glove Box Emblem
64-65 Running horse, curved *
C4ZB-65060A14-A
65-66 Running horse, flat * ..C5ZB-65060A14-A

GLOVE BOX LATCH



A great optional accessory from Scott Drake. All new tooling was created to produce our glovebox latches. Also available

as a locking version with keys.
Glove Box Latch
64-65 std., curved glove box door
C5ZZ-6506072-A
65-66 dlx., flat glove box door C5ZZ-6506072-B
67-68 std.C6DZ-6506072-A
69-70 std.C9ZZ-6506072-A

GLOVE BOX LOCK



A great optional accessory from Scott Drake. All new tooling was created to produce our glovebox latches.

Includes 2 matching keys.
Glove Box Lock
64-65 std., curved doorC5ZZ-6506072-AL
65-66 dlx., flat doorC5ZZ-6506072-BL
67-68 std.C6DZ-6506072-AL
69-70 std.C9ZZ-6506072-AL

GLOVE BOX OR TRUNK LOCK SET



New from Scott Drake. All new tooling was created to produce our glovebox latches. This kit allows use of the same key for both the glovebox and trunk lock.

Glove Box or Trunk Lock Set
67-68C6DZ-6506072-K
69-70C9ZZ-6506072-K

GLOVE BOX SCREW KIT

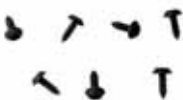

Correct broad head screws with black finish.

Glove Box Screw Kit
64-66382086-SK

GLOVE BOX STRIKER SET



Exact reproduction of the original. Hardware included.

Glove Box Striker Set
64-66 ZincC5ZZ-6506064-A
64-66 ChromeC5ZZ-6506064-C

HEADLINERS

COUPE HEADLINER



Scott Drake now produces some of the best headliners on the market. Formerly

available under the Classic Auto Trim label, our headliners have been preferred by professional installers for years. Manufactured with pride in the U.S. with the most correct fabric available. Precision cut from time tested patterns for a perfect fit. Don't forget new sunvisors to complete the look.

Headliner, Coupe
64-70 AquaHL-FM-CP-65-AQ
64-70 BlackHL-FM-CP-65-BK
64-70 Medium blueHL-FM-CP-65-BL
64-70 Dark aquaHL-FM-CP-65-DA
64-70 Dark blueHL-FM-CP-65-DB
64-70 Dark greenHL-FM-CP-65-DG
64-70 Dark redHL-FM-CP-65-DR
64-70 Medium ivy goldHL-FM-CP-65-IG
64-70 Light blueHL-FM-CP-65-LB
64-70 Light greenHL-FM-CP-65-LG
64-70 MaroonHL-FM-CP-65-MR
64-70 Nugget goldHL-FM-CP-65-NG
64-70 ParchmentHL-FM-CP-65-PR
64-70 RedHL-FM-CP-65-RD
64-70 SaddleHL-FM-CP-65-SA
64-70 VermillionHL-FM-CP-65-VE
64-70 WhiteHL-FM-CP-65-WT
71-73 BlackHL-FM-CP-71-BK
71-73 Dark aquaHL-FM-CP-71-DA
71-73 Dark blueHL-FM-CP-71-DB
71-73 Dark greenHL-FM-CP-71-DG
71-73 Dark redHL-FM-CP-71-DR
71-73 GingerHL-FM-CP-71-GI
71-73 Light blueHL-FM-CP-71-LB
71-73 Medium blueHL-FM-CP-71-MB
71-73 MaroonHL-FM-CP-71-MR
71-73 ParchmentHL-FM-CP-71-PR
71-73 RedHL-FM-CP-71-RD
71-73 SaddleHL-FM-CP-71-SA
71-73 WhiteHL-FM-CP-71-WT

WE PROUDLY FEATURE AUTHENTIC MUSTANG REPRODUCTIONS FROM SCOTT DRAKE ENTERPRISES!



FASTBACK HEADLINER



Scott Drake now produces some of the best headliners on the market. Formerly

available under the Classic Auto Trim label, our headliners have been preferred by professional installers for years. Manufactured with pride in the U.S. with the most correct fabric available. Precision cut from time tested patterns for a perfect fit. Don't forget new sunvisors to complete the look.

Headliner, Fastback

65-68	Aqua	HL-FM-FB-65-AQ
65-68	Black	HL-FM-FB-65-BK
65-68	Medium blue	HL-FM-FB-65-BL
65-68	Dark aqua	HL-FM-FB-65-DA
65-68	Dark green	HL-FM-FB-65-DG
65-68	Dark red	HL-FM-FB-65-DR
65-68	Medium ivy gold	HL-FM-FB-65-IG
65-68	Light blue	HL-FM-FB-65-LB
65-68	Light green	HL-FM-FB-65-LG
65-68	Medium blue	HL-FM-FB-65-MB
65-68	Maroon	HL-FM-FB-65-MR
65-68	Nugget gold	HL-FM-FB-65-NG
65-68	Parchment	HL-FM-FB-65-PR
65-68	Bright red	HL-FM-FB-65-RD
65-68	Saddle	HL-FM-FB-65-SA
65-68	Tan	HL-FM-FB-65-TA
65-68	White	HL-FM-FB-65-WT
69-70	Aqua	HL-FM-FB-69-AQ
69-70	Black	HL-FM-FB-69-BK
69-70	Medium blue	HL-FM-FB-69-BL
69-70	Dark aqua	HL-FM-FB-69-DA
69-70	Dark blue	HL-FM-FB-69-DB
69-70	Dark green	HL-FM-FB-69-DG
69-70	Dark red	HL-FM-FB-69-DR
69-70	Ivy gold	HL-FM-FB-69-IG
69-70	Light blue	HL-FM-FB-69-LB
69-70	Light green	HL-FM-FB-69-LG
69-70	Medium blue	HL-FM-FB-69-MB
69-70	Maroon	HL-FM-FB-69-MR
69-70	Nugget gold	HL-FM-FB-69-NG
69-70	Parchment	HL-FM-FB-69-PR
69-70	Red	HL-FM-FB-69-RD
69-70	Saddle	HL-FM-FB-69-SA
69-70	White	HL-FM-FB-69-WT
71-73	Black	HL-FM-FB-71-BK
71-73	Dark blue	HL-FM-FB-71-DB
71-73	Dark green	HL-FM-FB-71-DG
71-73	Ginger	HL-FM-FB-71-GI
71-73	Light blue	HL-FM-FB-71-LB
71-73	Medium blue	HL-FM-FB-71-MB
71-73	Maroon	HL-FM-FB-71-MR
71-73	Red	HL-FM-FB-71-RD
71-73	Saddle	HL-FM-FB-71-SA
71-73	Tan	HL-FM-FB-71-TA
71-73	Turquoise	HL-FM-FB-71-TQ
71-73	White	HL-FM-FB-71-WT

FASTBACK HEADLINER BOW

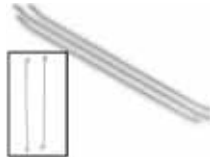

Headliner Bow, Fastback

67-68 5 pieces C7ZZ-6352101-K

HEADLINER ROD RETAINER



Headliner Rod Retainer

64-68 CP C0AB-6542180-K

Commonly missing or bent out of shape. A must for correct headliner installation.

HEADLINER GLUE



Headliner Glue

64-73 HLG-1829

This high strength glue comes in an easy to use 4 ounce container with brush applicator built into lid.

HEADLINER INSULATION PAD



Headliner Insulation Pad

64-68 CP HL-CP-PAD
64-68 FB HL-FB-PAD

HEADLINER PILLAR TRIM SET



Headliner Pillar Trim Set

64-68 C5ZZ-6552136/7

These commonly missing pieces are now available. Painted black. Mounting screws included.

PILLAR MOLDING



Pillar Molding

69-70 FB, black C9ZZ-6303598/9B
69-70 FB, white C9ZZ-6303598/9W
69-70 CP, black C9ZZ-6503598/9B
69-70 CV, black C9ZZ-7603598/9B

New reproductions of a commonly damaged part. Mounting hardware included. Ready to install.

PILLAR POST PAD



Molded in high-grade urethane, these parts are exactly like the originals.

Pillar Post Pad

67-68 Black, RH C7ZZ-6503598-BK
67-68 Blue, RH C7ZZ-6503598-BL
67-68 Ivy gold, RH C7ZZ-6503598-IG
67-68 Parchment, RH C7ZZ-6503598-PR
67-68 Red, RH C7ZZ-6503598-RD
67-68 Black, LH C7ZZ-6503599-BK
67-68 Blue, LH C7ZZ-6503599-BL
67-68 Ivy gold, LH C7ZZ-6503599-IG
67-68 Parchment, LH C7ZZ-6503599-PR
67-68 Red, LH C7ZZ-6503599-RD

HEADLINER TRIM SIDE PANEL



Precision die-cut construction black chipboard. Covered with matching headliner material.

Headliner Trim Side Panel

69-70 No cover, panel only C9ZZ-6352018-9P
69-70 Black, moonskin C9ZZ-63520189BK
69-70 Medium blue, moonskin .. C9ZZ-63520189BL
69-70 Dark green, moonskin .C9ZZ-63520189DG
69-70 Dark red, moonskin C9ZZ-63520189DR
69-70 Light blue, moonskin .. C9ZZ-63520189LB
69-70 Light green, moonskin C9ZZ-63520189LG
70 Red, moonskin C9ZZ-63520189RD
69-70 White, moonskin C9ZZ-63520189WT
71-73 No cover, panel only D1ZZ-6352018/9P
71-73 Black, tier grain D1ZZ-63520189BK
71-73 Blue, tier grain D1ZZ-63520189BL
71-73 Dark green, tier grain . D1ZZ-63520189DG
71-73 Ginger, tier grain D1ZZ-63520189GI
71-73 Maroon, tier grain D1ZZ-63520189MR
71-73 Red, tier grain D1ZZ-63520189RD
71-73 White, tier grain D1ZZ-63520189WT

INSTRUMENT PANEL & GAUGES

AMPERAGE GAUGE



These high quality gauges are manufactured with UV coating to protect the silk screened printing from fading. Gauges are

exact reproductions complete with the Ford part number and logos. All gauges are pre-tested for accuracy. (66 version will not fit 65)

Gauge, Amperage

66 * C5ZF-10671
69 Black C9ZF-10671-A
70 Gray D0ZF-10671-A

FUEL GAUGE

* These high quality gauges are manufactured with UV coating to protect the silk screened printing from fading. Gauges are exact reproductions complete with the Ford part number and logos. All gauges are pre-tested for accuracy.
Gauge, Fuel



64-65: std.*
C5DF-9306



65-66: GT*
C5ZF-9306



69: Black*
C9ZF-9280
70: Gray*
D0ZF-9280

OIL PRESSURE GAUGE

* These high quality gauges are manufactured with UV coating to protect the silk screened printing from fading. Gauges are exact reproductions complete with the Ford part number and logos. All gauges are pre-tested for accuracy.
Gauge, Oil Pressure



65-66*
C5ZF-9B309



69: Black
C9ZF-9B309-A
70: Gray
D0ZF-9B309-A

SPEEDOMETER GAUGE

* This high quality speedometer gauge is an exact reproduction of the original, complete with correct Ford part number and logo. The silk screened print is UV protected for longer life and fade resistance. All gauges are pre-tested for accuracy.
Gauge, Speedometer



64-65: std.*
C5DF-17266



65: GT*
C5ZF-17265



69: Black*
C9ZF-17265
70: Gray*
D0ZF-17265

FUEL/TEMP GAUGE

* Exact reproductions of the factory gauges.

Gauge, Fuel/Temp



69: Black*
C9ZF-9A284
69: Gray*
D0ZF-9A284

TACHOMETER GAUGE

The classic hood mounted tach from the 60's. Black plastic housing with a black dial face and bright back lit numbers makes this a great add-on accessory. Feature a red-line needle. Holes must be drilled in the hood for proper installation.

Gauge, Tachometer



65-70: Black face, 8000 RPM
C8AZ-17A326-B



65-70: White face, 8000 RPM
C8AZ-17A326-W

TEMPERATURE GAUGE

* These high quality gauges are manufactured with UV coating to protect the silk screened printing from fading. Gauges are exact reproductions complete with the Ford part number and logos. All gauges are pre-tested for accuracy.
Gauge, Temperature



64-65: std.*
C5DF-10971



65-66: GT*
C5ZF-10971



69: Black*
C9ZF-10B966
70: Gray*
D0ZF-10B966

NOTE: Rally Pacs can be found later in the INTERIOR category

INSTRUMENT BEZEL MOUNTING SET



These are the screws that attach the instrument cluster bezel to the dash.

Instrument Bezel Mounting Set

64-66 C5ZZ-10848-MK

DIGITAL INSTRUMENT PANEL GAUGES



These kits offer easy installation using your

original dash cluster or most aftermarket reproduction clusters. Microprocessor controlled for high accuracy and long-term dependability. Includes 6 LED gauges: speedometer, tach, oil pressure, water temp., voltmeter, and fuel level. Available with red, blue, green, or amber LED's. Lifetime warranty on all electronics.

Gauges, Digital Instrument Panel

65-66 Amber LED's C6ZZ-10890-D-A
65-66 Blue LED's C6ZZ-10890-D-B
65-66 Green LED's C6ZZ-10890-D-G
65-66 Red LED's C6ZZ-10890-D-R

INSTRUMENT BEZEL

Our bezel are the best, they feature details that other simply don't have. Chrome is superior and all fit accurately.

Instrument Bezel



64-65: Black, camera case finish
C5ZZ-10838-A



65: GT, Black
C5ZZ-10838-C



65-66: Pony, w/ vinyl woodgrain insert
C5ZZ-10838-B



65-66: Pony, w/ woodgrain insert (metal backed)
C5ZZ-10838-BMI



66: Black
C6ZZ-10838-A



67: dlx., brushed alum.
C7ZZ-10838-B



67: Black
C7ZZ-10838-C



68: Black, camera case finish
C8ZZ-10838-A



68: dlx., w/ woodgrain insert (economy vinyl decal)
C8ZZ-10838-B



68: dlx., w/ woodgrain insert (metal backed woodgrain)
C8ZZ-10838-BMI



69: Black, camera case finish
C9ZZ-10838-A



70: Black, camera case finish
D0ZZ-10838-A



71-73: Black
D1ZZ-10838-A













WE PROUDLY FEATURE AUTHENTIC MUSTANG REPRODUCTIONS FROM SCOTT DRAKE ENTERPRISES!



INSTRUMENT LENS

Optical grade injection molded plastic.

Instrument Lens

-  64: Generator style
C4DZ-10887-A
-  65: Alternator style
C5Z-10887-A
-  65-66: Full instrumentation
C5Z-10887-B
-  67-68: Speedometer, oil, alternator
C7Z-10887-A
-  67-68: 5 piece set
C7Z-10887-A/C
-  67-68: 5 piece set, w/ tach
C7Z-10887-A/D
-  67-68: Speedometer, w/ tach
C7Z-10887-B
-  67-68: Fuel, temperature
C7Z-10887-C
-  67-68: Center, w/ hole for clock
option
C7Z-10887-D
-  69-70: Set, w/out tach
C9Z-10887-A
-  69-70: Set, w/ tach
C9Z-10887-T
-  71-73: w/out tach
D1Z-10887-AR

INSTRUMENT LENS ANTI-RATTLE PAD



This simple little kit takes care of those rattles between the instrument lens and the bezel.

Instrument Lens Anti-Rattle Pad

- 64-65 10 piece set C4DZ-10856
- 66 13 piece set C6DZ-10856

INSTRUMENT PANEL & GLOVE BOX



This kit will really make your interior stand out. We have taken our beautiful reproduction

65 GT instrument panel and flat glove box door and added brushed aluminum inserts. The glove box door comes without the horse emblem for a clean look. This also allows you to add the emblem of your choice. Brushed aluminum panels are also available as a set without the instrument panel or door.

Instrument Panel and Glove Box

- 65-66KIT-INT-AL

INSTRUMENT PANEL & GLOVE BOX INSERT



These fit our 65 GT instrument panel and our flat glove box door.

Instrument Panel and Glove Box Insert

- 65-66 alum.KIT-INT-ALMI
- 65-66 WoodgrainWG-126-V

INSTRUMENT PANEL INSERT



These are metal backed wood grained panels. Under extreme heat these will not peel like

competitors. Las Vegas summer tested. See our Glove Box section, earlier in this category, for matching glove box inserts.

Instrument Panel Insert

- 65-66 WoodgrainC5Z-10838-WMI

INSTRUMENT PANEL LIGHT FILTER



Add new brightness to your instrument gauge panel. They look great on stock panels or with our white-face panel inserts. Set of 8

Instrument Panel Light Filter

- 67-70 BlueC4VY-10B870-B-8
- 67-70 RedC4VY-10B870-R-8
- 67-70 Amber/yellowC4VY-10B870-Y-8

INSTRUMENT PANEL LIGHT FILTER KIT



Add new brightness to your instrument gauge panel. They look great on stock panels or with our white-face panel

inserts. 4 Filter set with mounting screws







Instrument Panel Light Filter Kit

- 64-66 BlueC4VY-10B870-B-4
- 64-66 RedC4VY-10B870-R-4
- 64-66 Amber/yellowC4VY-10B870-Y-4

ELECTRO LUMINESCENT INSTRUMENT PANEL SET

A Scott Drake exclusive. Our panels actually glow! Light intensity can be changed with a dedicated controller. Color can be changed from soft blue to soft green with the push of a button. Instrument bezel and actual gauges are not included.

Instrument Panel Set, Electro Luminescent

-  65: 3 piece
C5Z-10890-GLO
-  66: 5 piece
C6Z-10890-GLO
-  67-68: 11 piece, no tach
C7Z-10890-GLO
-  67-68: 6 piece, 6000 RPM
C7Z-17360-GLO6
-  67-68: 6 piece, 8000 rpm
C7Z-17360-GLO8
-  69-70: 6 piece, no tach
C9Z-10890-GLO
-  71-73: 5 piece
D1Z-10890-GLO

WHITE FACE INSTRUMENT PANEL SET

These inexpensive kits are perfect for the resto-mod or anyone looking for a more modern look. These kits are installed onto your original black faced gauges with double sided tape. All numbers, letters and markings are copied exactly as original. Perfectly die cut to ease installation. Instrument bezel and actual gauges are not included.

Instrument Panel Set, White Face

-  64-65: 3 piece
C5Z-10890-W
-  65-66: 5 piece
C6Z-10890-W
-  67-68: 11 piece, w/out tach
C7Z-10890-W

TRIP RESET BUTTON ASSEMBLY



A wonderful reproduction of a very hard to find part. Designed for easy installation and adjustment.

Trip Reset Button Assembly

- 67-68C7Z-17A381-B

KICK PANEL

64-68 KICK PANELS



Molded in the same textured plastic as the originals. The finest available anywhere.

Kick Panels, 64-68

64-65	CP/FB, medium blue	. C5ZZ-65023445BL
64-65	CP/FB, bright redC5ZZ-65023445BR
64-65	CP/FB, ivy goldC5ZZ-65023445IG
64-65	CP/FB, palominoC5ZZ-65023445PA
64-65	CP/FB, whiteC5ZZ-65023445WT
64-65	CV, blueC5ZZ-76023445BL
64-65	CV, bright redC5ZZ-76023445BR
64-65	CV, ivy goldC5ZZ-76023445IG
64-65	CV, palominoC5ZZ-76023445PA
64-66	CP/FB, blackC5ZZ-65023445BK
64-66	CV, blackC5ZZ-76023445BK
64-66	CV, whiteC5ZZ-76023445WT
66	CP/FB, aquaC6ZZ-65023445AQ
66	CP/FB, dark redC6ZZ-65023445DR
66	CP/FB, light blueC6ZZ-65023445LB
66	CP/FB, parchmentC6ZZ-65023445PR
66	CP/FB, aquaC6ZZ-76023445AQ
66	CV, dark redC6ZZ-76023445DR
66	CV, light blueC6ZZ-76023445LB
66	CV, parchmentC6ZZ-76023445PR
67	CP/FB, dark redC7ZZ-65023445DR
67-68	CP/FB, blackC7ZZ-65023445BK
67-68	CP/FB, blueC7ZZ-65023445BL
67-68	CP/FB, ivy goldC7ZZ-65023445IG
67-68	CP/FB, parchmentC7ZZ-65023445PR
67-68	CP/FB, saddleC7ZZ-65023445SA
67-68	CP/FB, turquoiseC7ZZ-65023445TQ
67-68	CV, blackC7ZZ-76023445BK
67-68	CV, blueC7ZZ-76023445BL
67-68	CV, dark redC7ZZ-76023445DR
67-68	CV, ivy goldC7ZZ-76023445IG
67-68	CV, parchmentC7ZZ-76023445PR
67-68	CV, saddleC7ZZ-76023445SA
67-68	CV, turquoiseC7ZZ-76023445TQ
68	CV, nugget goldC8ZZ-76023445NG
68	CP/FB, maroonC8ZZ-65023445MA
68	CP/FB, nugget gold	. C8ZZ-65023445NG
68	CV, maroonC8ZZ-76023445MR
68	CV, nugget goldC8ZZ-76023445NG

69-70 KICK PANELS



Exact reproduction. Injection molded black plastic. Very nice.

Kick Panels, 69-70

69-70	BlackC9ZZ-6502344/5
-------	-------	---------------------

64-66 KICK PANELS FOR SPEAKERS



The perfect place to install a speaker without doing permanent damage. These new vacuum formed panels feature original style grain and raised platform for

speaker installation. Improve sound quality while maintaining factory appearance. Speakers not included. See audio section for kick panel with speakers. Note: Panels can be modified to fit 67-68, requires trimming on top.

Kick Panels For Speakers, 64-66

64-66	CP/FB, black, also fits 67-68 w/ modificationsC5ZZ-65023445SP
64-66	CV, black, also fits 67-68 w/ modificationsC5ZZ-76023445SP

PONY KICK PANEL CARPET



Made by ACC. Matches the 80/20 blend carpets. Mounts to the lower half of kick panel.

Kick Panel Carpet, Pony

65-66	CV, bright blueKPC-CNV-BB
65-66	CV, blackKPC-CNV-BK
65-66	CV, dark blueKPC-CNV-DB
65-66	CV, dark greenKPC-CNV-DG
65-66	CV, emberglowKPC-CNV-EM
65-66	CV, ivy goldKPC-CNV-IG
65-66	CV, maroonKPC-CNV-MR
65-66	CV, redKPC-CNV-RD
65-66	CV, saddleKPC-CNV-SA
65-66	CV, turquoiseKPC-CNV-TQ
65-66	CP/FB, dark greenKPC-CP/FB-DG
65-66	CP/FB, bright blueKPC-CPFB-BB
65-66	CP/FB, blackKPC-CPFB-BK
65-66	CP/FB, dark blueKPC-CPFB-DB
65-66	CP/FB, emberglowKPC-CPFB-EM
65-66	CP/FB, ivy goldKPC-CPFB-IG
65-66	CP/FB, moss greenKPC-CPFB-MG
65-66	CP/FB, maroonKPC-CPFB-MR
65-66	CP/FB, redKPC-CPFB-RD
65-66	CP/FB, saddleKPC-CPFB-SA
65-66	CP/FB, turquoiseKPC-CPFB-TQ

KICK PANEL TRIM



Excellent reproductions, made from rust proof 304 stainless steel with a cadmium plated liner. Packaged in pairs.

Kick Panel Trim

65-66	C5ZZ-65023445SS
-------	-------	-----------------

OVERHEAD COMPONENTS

COAT HOOK

Coat Hooks are a great way to dress up your interior and install with ease.

Coat Hook



64-66: Chrome
C4AZ-6229025-A



64-67: 64-66 CV, 67 CP/Fasback, Chrome
B2A-7029025-A



68-73: Black, w/out base
C8AZ-6229024-A

COURTESY LIGHT BRACKET



Stamped metal bracket mounts under dash. Socket not included.

Courtesy Light Bracket

64-69	COAZ-13763-A
-------	-------	--------------

DOME LIGHT ASSEMBLY



We made a bright chrome base with a brighter than original bulb to really improve lighting inside the car. We include

instructions on how to easily add this dome lamp to earlier Mustangs that didn't have this feature. Our dome light assembly can even be mounted up under the back deck to make a great trunk light. Our reproduction dome lens and chrome bezel as well as the mounting hardware and electrical connectors are included to make this a quick and simple project.

Dome Light Assembly

65-70	COAF-13A719-B
-------	-------	---------------

DOME LIGHT HOUSING

Housing is chromed plastic.

Dome Light Housing



67-70
COAF-13788-A



71-73
D6UZ-13788-A

WE PROUDLY FEATURE AUTHENTIC MUSTANG REPRODUCTIONS FROM SCOTT DRAKE ENTERPRISES!



DOMELIGHT LENS

High quality injection molded parts, exactly like the originals. Lens is milk white.
Dome Light Lens



67-70
COAF-13783-C



71-73
D1AZ-13783-B

REAR VIEW MIRROR

Exact copies, with all the right details. Improved mirror with superior quality crimping of frame to glass.

Rear View Mirror



64-66: Show quality
CSZZ-17700-A



64-65: Day/Night push button
CSZZ-17700-B



65-66: Day/Night turn button
C6ZZ-17700-A



67: Day/Night
C7ZZ-17700-A



68-69: Day/Night
C7AZ-17700-G



68-70: Day/Night
C8AZ-17700-A

REAR VIEW MIRROR AND ARM KIT



Save money with this quite attractive new kit. Includes standard mirror and our pressure die cast arm.

Rear View Mirror and Arm Kit

64-66 KIT-MIR-1

REAR VIEW MIRROR ARM

Pressure die cast, with quality chrome. Replaces one of the most visible interior parts.
Rear View Mirror Arm



64-66
CSZZ-17690-D



67
C7ZZ-17690-A

Rear View Mirror Arm



68-69
C2SZ-17690-F

REAR VIEW MIRROR MOUNT



Special cast-metal bracket glues to windshield. Plain finish. Exact detail.

Rear View Mirror Mount

68-69 C8AZ-17698-A
70-79 C9AZ-17698-A

COUPE/FASTBACK SUN VISOR



Coupe and Fastback visors are fully padded and covered with the original Moonskin Vinyl on 1964-1970 and with Tier Grain on 1971-1973.

Sun Visor, Coupe and Fastback

64-65 Medium blue CSZZ-6504104-BL
64-65 Bright red CSZZ-6504104-BR
64-66 Black CSZZ-6504104-BK
64-66 Ivy gold CSZZ-6504104-IG
64-66 Light green/ivy gold .. CSZZ-6504104-LG
64-66 White CSZZ-6504104-WT
65-66 Parchment CSZZ-6504104-PR
66 Aqua CSZZ-6504104-AQ
66 Dark red CSZZ-6504104-DR
66 Light blue CSZZ-6504104-LB
66 Turquoise CSZZ-6504104-TQ
67-68 Aqua C7ZZ-6504104-AQ
67-68 Black C7ZZ-6504104-BK
67-68 Dark red C7ZZ-6504104-DR
67-68 Ivy gold C7ZZ-6504104-IG
67-68 Light blue C7ZZ-6504104-LB
67-68 Light green/ivy gold .. C7ZZ-6504104-LG
67-68 Parchment C7ZZ-6504104-PR
67-68 Saddle C7ZZ-6504104-SA
67-68 White C7ZZ-6504104-WT
69-70 Black C9ZZ-6504104-BK
69-70 Medium blue C9ZZ-6504104-BL
69-70 Dark green C9ZZ-6504104-DG
69-70 Dark red C9ZZ-6504104-DR
69-70 Ivy gold C9ZZ-6504104-IG
69-70 Light blue C9ZZ-6504104-LB
69-70 Parchment C9ZZ-6504104-PR
69-70 White C9ZZ-6504104-WT
71-73 Black D1ZZ-6504104-BK
71-73 Blue D1ZZ-6504104-BL
71-73 Dark green D1ZZ-6504104-DG
71-73 Ginger D1ZZ-6504104-GI
71-73 Maroon D1ZZ-6504104-MR
71-73 Red D1ZZ-6504104-RD
71-73 White D1ZZ-6504104-WT

CONVERTIBLE SUN VISOR



Convertible visors are covered in the original Sierra Grain vinyl.

Sun Visor, Convertible

64-65 Medium blue CSZZ-7604104-BL
64-65 Bright red CSZZ-7604104-BR
64-66 Black CSZZ-7604104-BK
64-66 Emberglo CSZZ-7604104-EM
64-66 Ivy gold CSZZ-7604104-IG
64-66 Palamino CSZZ-7604104-PA
64-66 Turquoise CSZZ-7604104-TQ
64-66 White CSZZ-7604104-WT
65-66 Aqua CSZZ-7604104-AQ
66 Dark red CSZZ-7604104-DR
66 Light blue CSZZ-7604104-LB
66 Parchment CSZZ-7604104-PR
67-68 Aqua C7ZZ-7604104-AQ
67-68 Black C7ZZ-7604104-BK
67-68 Dark blue C7ZZ-7604104-DB
67-68 Dark red C7ZZ-7604104-DR
67-68 Ivy gold C7ZZ-7604104-IG
67-68 Light blue C7ZZ-7604104-LB
67-68 Parchment C7ZZ-7604104-PR
67-68 Saddle C7ZZ-7604104-SA
67-68 White C7ZZ-7604104-WT
68 Maroon C7ZZ-7604104-MR
68 Nugget gold C7ZZ-7604104-NG
69-73 Black C9ZZ-7604104-BK
69-73 Blue C9ZZ-7604104-BL
69-73 Dark ivy C9ZZ-7604104-DI
69-73 Dark red C9ZZ-7604104-DR
69-73 Green C9ZZ-7604104-GR
69-73 Ivy gold C9ZZ-7604104-IG
69-73 Light blue C9ZZ-7604104-LB
69-73 Nugget gold C9ZZ-7604104-LN
69-73 Parchment C9ZZ-7604104-PR
69-73 Vermillion C9ZZ-7604104-VE
69-73 White C9ZZ-7604104-WT

SUN VISOR BRACKET & ROD



Set includes brackets with visor pivots and inner rods. These are perfect parts! Coupe/

Fastback. For convertible sun visor brackets & dods, see the "Convertible" category, earlier in this catalog.

Sun Visor Bracket & Rod

64-66 Chrome CSZZ-6504144-A
67-70 Chrome C7AZ-6204144-A

SHOP WITH CONFIDENCE! WE OFFER SUPERIOR-QUALITY PARTS FOR ALL YOUR MUSTANG RESTORATION NEEDS.

CENTER SUN VISOR BRACKET

Plastic molded with original looking texture.
Sun Visor Bracket, Center



- 68: Black
C8ZZ-6204132-BK
- 68: Neutral
C8ZZ-6204132-NE
- 69-70: Black
C9AZ-6204132

SUN VISOR PIN AND TIP

Gray plastic rod with rubber tip. Fits most Ford's from the 70's.



Sun Visor Pin and Tip

- 70-73 Pin & tip D3AZ-6504114-B

SUN VISOR TIP

Soft rubber tips to go over the ends of the sun visor rods. Original gray color.



Sun Visor Tip

- 64-73 D1DZ-6204115-A

ROLL BAR

It is attractively finished in a black textured powder coated surface. Installation requires welding at floor



mounts. This roll bar will fit 65-66 Fastbacks with minor modification to floor mounts. Roof mount brackets and seat belt brackets are included. Must be shipped truck freight. We can drop ship from Midwest manufacturer for East Coast customers. Similar to 67-68 Shelby.

Roll Bar

- 65-68 S7MS-RB

VINYL TOP



Vinyl Top

- 64-70 Black VT-65-BK
- 64-70 White VT-65-WT

VINYL TOP MOLDING

Pressure die cast construction and chrome plated. Coupe only.



Vinyl Top Molding

- 65-66 C5ZZ-65423A18/9
- 67-68 C7ZZ-65423A18/9

WINDLACE



Snap on vinyl windlace, available in a variety of colors. Sold by the foot. Fastbacks and coupes require 16 feet, convertibles require 10 feet.

Windlace

- 64-70 Aqua C5ZZ-6502906-AQ
- 64-70 Black C5ZZ-6502906-BK
- 64-70 Medium blue C5ZZ-6502906-BL
- 64-70 Bright red C5ZZ-6502906-BR
- 64-70 Dark blue C5ZZ-6502906-DB
- 64-70 Dark red C5ZZ-6502906-DR
- 64-70 Ivy gold C5ZZ-6502906-IG
- 64-70 Light blue C5ZZ-6502906-LB
- 64-70 Parchment C5ZZ-6502906-PA
- 64-70 Saddle C5ZZ-6502906-SA
- 64-70 White C5ZZ-6502906-WT

PEDALS, PADS AND TRIM

ACCELERATOR PEDAL

These steel reinforced parts are molded from high quality rubber for a long life and great appearance.

Accelerator Pedal



- 64-68: w/ stainless trim
C5ZZ-9735-D



- 69-70: w/out trim
C9ZZ-9735-D

ACCELERATOR PEDAL MOUNTING SCREW

A precision machined screw with exact detail. Painted black.



Accelerator Pedal Mounting Screw

- 64-68 380503-5101

ACCELERATOR PEDAL SPRING

Made of strong spring steel for a long life.



Accelerator Pedal Spring

- 64-68 Spring steel C5ZZ-9760-B

BRAKE AND CLUTCH PEDAL PAD

Sold as a matching set for the clutch and brake pedals for manual transmission cars.



High quality EPDM rubber will look great for years.
Brake and Clutch Pedal Pad

- 65-68 5.0 C5ZZ-2457624-50

BRAKE PEDAL PAD

Made by Scott Drake with exact detail of the original. Compression molded rubber. Disc brake versions include stainless steel center trim.
Brake Pedal Pad



- 64-67: w/ power drum
CSZZ-2457-E



- 64-67: drum, auto.
CSZZ-2457-F



- 65-73: drum, manual
CSZZ-2457-G



- 68-73: drum, automatic
C60Z-2457-A

DISC BRAKE PEDAL PAD

These reproduction pads are high quality replacements for worn or missing original pads.

Brake Pedal Pad, Disc



- 65-67: disc, auto.
CSZZ-2454-C



- 65-73: disc, manual
CSZZ-2454-D



- 68-73: disc, auto.
D3ZZ-2454-A

BRAKE PEDAL PAD TRIM

Replacement brake pedal pad trim. Stainless steel construction.



Brake Pedal Pad Trim

- 65-67 auto. C5ZZ-2A487-B
- 65-73 manual D1ZZ-2A487-B
- 68-73 auto. C60Z-2A487-A

CLUTCH PEDAL PAD

These reproduction pads are high quality replacements for worn or missing original pads.
Clutch Pedal Pad



- 65-68
CSZZ-7A624-B



- 69-73
C9ZZ-7A624-A

CLUTCH PEDAL PAD TRIM

Replacement clutch pedal pad trim. Stainless steel construction.



Clutch Pedal Pad Trim

- 65-68 C5ZZ-7B544-A
- 69-73 C9ZZ-7B544-A

WE PROUDLY FEATURE AUTHENTIC MUSTANG REPRODUCTIONS FROM SCOTT DRAKE ENTERPRISES!



PARKING BRAKE PEDAL PAD

This Parking Brake Pad is an exact copy of the original. Molded from wear resistant rubber for years of use.

Parking Brake Pedal Pad



69-73: Note: Will not fit 1970 Mustang or Cougar
C9ZZ-2454-A

PARKING BRAKE PEDAL PAD TRIM



Made from stainless steel, just like the originals.

Parking Brake Pedal Pad Trim

69-73 Note: Will not fit 1970 Mustang or Cougar
C9ZZ-2A487-C

WASHER PUMP PEDAL PAD



Great reproduction of the original, with crisp detailing in the rubber.

Washer Pump Pedal Pad

69-68C7ZZ-17664-P

QUARTER PANELS

QUARTER PANEL ASH TRAY COVER



Exact reproduction of the original ash trays for the convertible. Stainless cover with plastic handle, and exact reproduction formed ashtray. Tray is zinc plated stamped steel.

exact reproduction formed ashtray. Tray is zinc plated stamped steel.

Ash Tray Cover, Quarter Panel

64-70 C1AB-7630714-A

QUARTER PANEL ASH TRAY RECEPTACLE



Exact reproduction of the original ash trays for the convertible. Stainless cover with plastic handle, and exact reproduction formed ashtray. Tray is zinc plated stamped steel.

ashtray. Tray is zinc plated stamped steel.

Ash Tray Receptacle, Quarter Panel

65-68C5AZ-7630702-A

INTERIOR QUARTER PANEL

Made from sturdy black ABS plastic with embossed grain pattern paint to match or cover quarter panel vinyl trim.

Interior Quarter Panel



64-66: Steel w/ embossed grain, RH
C5ZZ-7631004-R

64-66: Steel w/ embossed grain, LH
C5ZZ-7631005-L



64-68: CV, Fiberglass
C5ZZ-7631486/7A



65-66: FB, Fiberglass
C5ZZ-6331486/7A



67-68: FB, Fiberglass
C7ZZ-6331486/7A



67-68: FB, ABS inc. steel reinforcement & courtesy lights
C7ZZ-63314867-K

No Photo Available

69-70: FB, ABS
C9ZZ-6331486/7P

CONVERTIBLE QUARTER PANEL TRIM



Die cut and carefully sewn to assure you of a proper fit. Made from the original type upholstery material.

Original equipment on all convertibles and coupes with deluxe interior.

Quarter Panel Trim, Convertible

64-65 Medium blue C6ZZ-74407423BL

64-65 White C6ZZ-76607623WT

64-68 Black C5ZZ-76607623BK

65 Bright red C5ZZ-76607623BR

65-66 Palomino C5ZZ-76607623PA

65-68 Aqua C6ZZ-76607623AQ

65-68 Light blue C6ZZ-76607623LB

65-68 Ivy gold C7ZZ-76607623IG

66 Emberglow C6ZZ-76607623EM

66 Parchment C6ZZ-76607623PR

66-67 Dark red C6ZZ-76607623DR

67-68 Light parchment C7ZZ-76607623LP

67-68 Saddle C7ZZ-76607623SA

68 Maroon C8ZZ-76607623MR

68 Nugget gold C8ZZ-76607623NG

69-70 Black C9ZZ-76607623BK

69-70 Light blue C9ZZ-76607623BL

69-70 Ivy gold C9ZZ-76607623IG

69-70 Medium blue C9ZZ-76607623MB

69-70 White C9ZZ-76607623WT

COUPE QUARTER PANEL TRIM



Die cut and carefully sewn to assure your customers of a proper fit. Made from the original type

upholstery material. Original equipment on all convertibles and coupes with deluxe interiors.

Quarter Panel Trim, Coupe

64-65 Medium blue C6ZZ-65607623BL

64-68 Black C5ZZ-65607623BK

65 Bright red C5ZZ-65607623BR

65-68 Light blue C5ZZ-65607623LB

65-68 Palomino C5ZZ-65607623PA

65-68 Aqua C6ZZ-65607623AQ

65-68 Emberglow C6ZZ-65607623EM

65-68 Turquoise C6ZZ-65607623TQ

65-68 White C6ZZ-65607623WT

65-68 Ivy gold C7ZZ-65607623IG

66 Dark red C6ZZ-65607623DR

66-68 Parchment C6ZZ-65607623PR

67 Saddle C7ZZ-65607623SA

67-68 Parchment C7ZZ-65607623LP

68 Maroon C8ZZ-65607623MR

68 Nugget gold C8ZZ-65607623NG

QUARTER GLASS PIVOT ROD COVER



A nice reproduction of the rubber cover for the quarter glass pivot.

Quarter Glass Pivot Rod Cover

69-70 C9ZZ-6330246

RALLY PACS & GAUGE POD ASSEMBLIES

RALLY PAC CENTER DIAL



Chrome plated dial ornament.

Rally Pac Center Dial

66 C6ZZ-10C858-D

RALLY PAC CLOCK BULB



Replacement bulbs from O.E.M. suppliers to the auto industry. Excellent quality bulbs.

Rally Pac Clock Bulb

65-66 1816

SHOP WITH CONFIDENCE! WE OFFER SUPERIOR-QUALITY PARTS FOR ALL YOUR MUSTANG RESTORATION NEEDS.

RALLY PAC DUAL GAUGE HOUSING



Rally Pac housing and bezels are now available without gauges so that you may add your favorite

gauges for a custom project. Our housing can be mounted on the steering column or under the dash with the use of various brackets, available separately. Modifications are required to make aftermarket 2 5/16 inch gauges fit our housing and bezels. Included in this package are 2 chrome inner bezel rings and 2 gauge mounting compression rings.

Rally Pac Dual Gauge Housing

65-68 BlackS7MS-10B960-BK
65-68 SatinS7MS-10B960-S
65-68 WhiteS7MS-10B960-WT

ELECTRO LUMINESCENT RALLY PAC



Due to the popularity of our Electro Luminescent instrument panels, we

have incorporated this technology into our Rally Pacs. These are the same high quality gauges as the regular Rally Pac. Note: You must use the EL instrument cluster in order to power the Rally Pacs EL faces, cannot be used separately

Rally Pac, Electro Luminescent

66 V8, 6000 RPM, black	.C6ZZ-10B960CBKE
66 V8, 8000 RPM, black	.C6ZZ-10B960KBKE

RALLY PAC THEFT PROTECTION SCREW



Design especially for rally-pac mounting. These specialty screws will slow down any thief. Kit includes two black button-head

socket screws, lock washers and special tool to install and remove.

Rally Pac Theft Protection Screw

64-66379773-S
-------	---------------

POLISHED ALUMINUM BULLET



Another creative custom accent by Scott Drake. We have precision machined our

aluminum bullets and finished them off with a beautiful polish. These look great on the face of the Tri-bar head lamps or as replacement center ornaments on a 1966 Rally Pac. Limitless possibilities for all other cars as well. Use silicone adhesive to secure.

Bullet, Polished Aluminum

64-73ACC-BULLITTS
-------	-------------------



RALLY PAC

This is the Ultimate accessory for your 65-66 Mustang. Our Rally Pac features a modern air-core movement tachometer and a quartz movement clock. Both the clock and tachometer faces feature the original style fonts and are back lit for improved visibility at night. The housing and bezels are pressure zinc die-cast from our own tooling and coated with

a tough Du Pont® crinkle texture. Our Rally Pac's include all of the brackets, color coded wire harnesses and easy to follow installation instructions.

- Available in the 6 most popular 1966 Mustang interior colors, new Satin chrome, or any original interior color by special order.

- Available for 6 or 8 cylinder engine applications.

Rally Pac

65-66	6 cyl., 6000 RPM, blackC6ZZ-10B960TBK
65-66	6 cyl., 6000 RPM, satinC6ZZ-10B960TSN
65-66	6 cyl., 6000 RPM, whiteC6ZZ-10B960TWT
66	6 cyl., 6000 RPM, aquaC6ZZ-10B960TAQ
66	6 cyl., 6000 RPM, dark redC6ZZ-10B960TDR
66	6 cyl., 6000 RPM, ivy goldC6ZZ-10B960TIG
66	6 cyl., 6000 RPM, light blueC6ZZ-10B960TLB
66	6 cyl., 6000 RPM, parchmentC6ZZ-10B960TPA
65-66	V8, 6000 RPM, blackC6ZZ-10B960CBK
65-66	V8, 6000 RPM, satinC6ZZ-10B960CSN
65-66	V8, 6000 RPM, whiteC6ZZ-10B960CWT
66	V8, 6000 RPM, aquaC6ZZ-10B960CAQ
66	V8, 6000 RPM, dark redC6ZZ-10B960CDR
66	V8, 6000 RPM, ivy goldC6ZZ-10B960CIG
66	V8, 6000 RPM, light blueC6ZZ-10B960CLB
66	V8, 6000 RPM, parchmentC6ZZ-10B960CPA
65-66	V8, 8000 RPM, blackC6ZZ-10B960KBK
65-66	V8, 8000 RPM, satinC6ZZ-10B960KSN
65-66	V8, 8000 RPM, whiteC6ZZ-10B960KWT
66	V8, 8000 RPM, aquaC6ZZ-10B960KAQ
66	V8, 8000 RPM, dark redC6ZZ-10B960KDR
66	V8, 8000 RPM, ivy goldC6ZZ-10B960KIG
66	V8, 8000 RPM, light blueC6ZZ-10B960KLB
66	V8, 8000 RPM, parchmentC6ZZ-10B960KPA

RALLY PAC LENSES



Fabricated plastic construction.

Rally Pac Lenses

65	ClockC5ZZ-15000-L
65	TachC5ZZ-17360-L
66	ClockC6ZZ-15000-L
66	TachC6ZZ-17306-L

RALLY PAC TRIM RING



Chrome plated plastic trim ring. Sold individually.

Rally Pac Trim Ring

66C6ZZ-10C858-A
----	--------------------

RALLY PAC MOUNTING CLAMP



Holds rally pack to steering column. Stamped steel and painted black. Includes rubber pad and mounting screws.

Rally Pac Mounting Clamp

65C5ZZ-3676-A
----	------------------

RALLY PAC MOUNTING KIT



Includes mounting clamp, wire channel cover, rubber pad and mounting hardware. This kit is included

when purchasing our new RallyPac.

Rally Pac Mounting Kit

66	BlackC6ZZ-3678-AK
66	WhiteC6ZZ-3678-WK

WE PROUDLY FEATURE AUTHENTIC MUSTANG REPRODUCTIONS FROM SCOTT DRAKE ENTERPRISES!



RALLY PAC REPAIR PIGTAIL KIT



This repair harness is used to replace Rally-Pacs with damaged leads. Kit includes

clock and tach harness plus four crimp on connectors.

Rally Pac Repair Pigtail Kit

64-65	CSZZ-15A006-FX
65-66	C6ZZ-15A006-FX

RALLY PAC UNDER DASH HARNESS



Harness that plugs into main under dash harness. This harness must be used when

installing a Rally Pac in a car that did not originally come with one.

Rally Pac Under Dash Harness

64-66	CSZZ-15A006-UD
-------	-------	----------------

SHELBY TACH DASH BRACKET



Concours correct reproduction with wrinkle finish. Stamped steel.

Tach Dash Bracket, Shelby

66	S2MS-17360-B
----	-------	--------------

1967 UNDER DASH GAUGE POD ASSEMBLY



We are proud to have the Scott Drake name on this Gauge Pod Assembly, an authentic reproduction of the

original 1967 Shelby under dash gauge pod! Features Stewart Warner green line gauges and a tough, crinkle coated housing. Includes oil pressure & Amp gauges, mounting bracket, face plate, and all hardware and connectors needed for proper installation. Fits 1967 Shelby and 1967-68 Mustangs without center console. Universal fit for other under dash applications may also be possible.

Gauge Pod Assembly, 1967 Under Dash

67-68	Black	S7MS-10B969-A
-------	-------	-------	---------------

1967 UNDER DASH GAUGE POD BRACKET



Never before available. We have produced the hanging bracket for the under dash gauge pod originally found in the

1967 Shelby. Made of heavy duty steel with exact detail and painted flat black.

Gauge Pod Bracket, 1967 Under Dash

67	S7MS-3676-A
----	-------	-------------

1967 UNDER DASH GAUGE POD

FACE PLATE



We have reproduced the original face plate for the 1967 Shelby underdash gauge

pod. Features black wrinkle finish just like the original.

Gauge Pod Face Plate, 1967 Under Dash

67	S7MS-17187-A
----	-------	--------------

REAR DECK

FIBERGLASS & FIBERBOARD PACKAGE TRAY



Package Tray, Fiberglass and Fiberboard

64-68	CP, fiberboard	CSZZ-6546656
67-68	FB, fiberboard, no fold down seat	C7ZZ-6346656
69-70	FB, fiberglass	C9ZZ-6346656
69-70	CP, fiberglass	C9ZZ-6546656
69-70	FB, fiberboard	C9ZZ-6546656-C

COUPE VINYL PACKAGE TRAY



Designed to match your interior for a clean, finished look. Made of

tough Masonite® and vinyl. Easy to install. Also available with speaker holes.

Package Tray, Coupe Vinyl

64-65	Dark blue	CSZZ-6546656-BL
64-68	Black	CSZZ-6546656-BK
65	Palomino	CSZZ-6546656-PA
65	Bright red	CSZZ-6546656-RD
65-66	Emberglo	CSZZ-6546656-EM
65-66	White	CSZZ-6546656-WT
65-68	Aqua	CSZZ-6546656-AQ
65-68	Ivy gold	CSZZ-6546656-IG
65-68	Light blue	CSZZ-6546656-LB
66	Parchment	CSZZ-6546656-PR
66-67	Dark red	CSZZ-6546656-DR
67-68	Parchment	C7ZZ-6546656-PR
67-68	Saddle	C7ZZ-6546656-SA
68	Dark red	C8ZZ-6546656-DR
68	Nugget gold	C8ZZ-6546656-NG

COUPE VINYL PACKAGE TRAY WITH

HOLES



Designed to match your interior for a clean, finished look. Made

of tough Masonite® and vinyl. Easy to install. These come with precut speaker holes.

Package Tray With Holes, Coupe Vinyl

64-66	Black	CSZZ-6546656BKH
64-68	Aqua	CSZZ-6546656AQH
65	Dark blue	CSZZ-6546656BLH
65	Palomino	CSZZ-6546656PAH
65	Red	CSZZ-6546656RDH
65-66	Emberglo	CSZZ-6546656EMH
65-66	Ivy gold	CSZZ-6546656IGH
65-66	Light blue	CSZZ-6546656LBH
65-66	White	CSZZ-6546656WTH
66	Dark red	CSZZ-6546656DRH
66	Parchment	CSZZ-6546656PRH
67	Dark red	C7ZZ-6546656DRH
67-68	Aqua	C7ZZ-6546656AQH
67-68	Black	C7ZZ-6546656BKH
67-68	Ivy gold	C7ZZ-6546656IGH
67-68	Light blue	C7ZZ-6546656LBH
67-68	Parchment	C7ZZ-6546656PRH
67-68	Saddle	C7ZZ-6546656SAH
68	Dark red	C8ZZ-6546656DRH
68	Nugget gold	C8ZZ-6546656NGH

SEAT BELTS

AFTERMARKET SEAT BELT



Great looking replacement style seat belts. All feature a mid sixties period look which includes a chrome buckle.

Available in a variety of colors.

Seat Belt, Aftermarket

60-73	Aqua	SB-AQ
60-73	Black	SB-BK
64-73	Light blue	SB-BL
64-73	Bright red	SB-BR
64-73	Dark blue	SB-DB
64-73	Dark red	SB-DR
64-73	Light green	SB-GN
64-73	Maroon	SB-MR
64-73	Parchment/palomino	SB-PR
64-73	Saddle	SB-SA
64-73	White	SB-WT

SHOP WITH CONFIDENCE! WE OFFER SUPERIOR-QUALITY PARTS FOR ALL YOUR MUSTANG RESTORATION NEEDS.

BLACK WRINKLE SEAT BELT



Exclusively from Scott Drake. We had these seat belts powder coated black with a textured finish to more closely resemble original style

seat belts. Includes mounting hardware.
Seat Belt, Black Wrinkle
 64-73 Black wrinkle SB-BK-DLX

MUSTANG EMBLEM SEAT BELT



These aftermarket seat belts are sure to turn heads. Replace your old belts with

these new ones that feature a pair of brilliantly painted Tri-bar pony emblems. Available in all popular colors. Sold in matching pairs with all hardware included for easy installation.

Seat Belt, Mustang Emblem

- 64-73 Aqua* SB-AQ-H
- 64-73 Black* SB-BK-H
- 64-73 Light blue* SB-BL-H
- 64-73 Bright red* SB-BR-H
- 64-73 Dark blue* SB-DB-H
- 64-73 Dark red* SB-DR-H
- 64-73 Green* SB-GN-H
- 64-73 Maroon* SB-MR-H
- 64-73 Parchment* SB-PR-H
- 64-73 Saddle* SB-SA-H
- 64-73 White* SB-WT-H

RETRACTABLE SEAT BELT

Great looking replacement style seat belts. All feature a mid sixties period look which includes a chrome buckle.

Seat Belt, Retractable



64-73: Black, low profile retractor, (Will not fit 64-67 converts)
 SB-BK-65
 68-73: Black, will fit 64-67 CP/FB but not recommended for taller drivers (Will not fit 64-67 converts)
 SB-BK-68

SHOULDER SEAT BELT



Keep Yourself firmly planted in your seat with this retractable shoulder belt. These

aftermarket shoulder belts help bring another layer of protection to you while driving your classic Mustang. Features inertia locking mechanism. Instructions not included. Installer assumes all liability for a safe and secure installation. Note: Retractor unit may slightly limit rear seat travel adjustment on 1964-67 cars. Not for use on convertibles. 2 required per car.

Seat Belt, Shoulder

- 64-73 Black SB-BK-ASB

RETROBELT 3-POINT SEAT BELT



The RetroBelt 3-Point, retractable seatbelt kits feature all chrome, aviation style buckles and hardware. These safety belt systems

are federally approved and meet or exceed Federal Motor Vehicle Safety Standards.

The black and blue versions feature a black retractor unit. The following colors: Bright Red, Parchment, Green, and White feature color matched retractor units. Stitching and matching color plastic parts!

Mustang specific hardware not included. Use RetroBelt Seat Belt Hardware, Part # SB-3P-HK. Seat Belt, RetroBelt 3-point

- 64-73 Black SB-3P-BK
- 64-73 Blue* SB-3P-BL
- 64-73 Bright Red SB-3P-BR
- 64-73 Parchment SB-3P-PR
- 64-73 Green SB-3P-GN
- 64-73 White SB-3P-WT

* Retractor cover does not match

RETROBELT SEAT BELT HARDWARE

For use with our RetroBelt 3-Point Seat Belts. Mounting hardware is Grade 5 hardness to ensure maximum safety. This mounting kit is specifically designed for Mustangs. Not a universal kit. Includes instructions.

Seat Belt Hardware, RetroBelt

- 64-73 SB-3P-HK

CHROME SEAT BELT BOLT SET

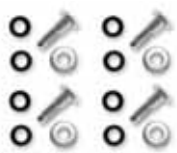

Concours correct for 65-67, but a nice dress-up item for 68-73.

Seat Belt Bolt Set, Chrome

- 64-73 Chrome 382627-K

SEAT BELT BUCKLE BEZEL



Replace those worn buckle bezels with our new chromed bezels. They just snap on. Brings life back to those old seat belts.

Seat Belt Buckle Bezel

- 68-70 C8AZ-65611A72-A

SEAT BELT BUCKLE BUTTON COVER



Exact detail of the seat belt buckle release button.

Seat Belt Buckle Button Cover

- 68-70 C8AZ-65611C02-A

SEAT BELT BUCKLE RESTORATION KIT



Perfect reproductions of commonly worn parts. Now bring those old seat belt buckles

back with our chrome bezels & highly detailed release button covers. One kit does a pair of belts.

Seat Belt Buckle Restoration Kit
 68-70 C8AZ-65611A72-K

SEAT BELT HOLDER



Holds seat belt in place when belts are not in use.

Seat Belt Holder

- 71-73 D1ZZ-6561280

SEAT BELT RETRACTOR



A great way to "tidy up" your interior as well as make your seat belts easier to use. Just pre-wind these retractors

and insert the belt into the notches, let go and the belt will roll up and stay in easy reach.

Seat Belt Retractor

- 64-67 C4AZ-65611A06

SEAT COMPONENTS

FRONT SEAT HINGE SHAFT

RETAINER CLIP SET



Special clip used to secure front seat back to seat bottom. Two required per seat.

Front Seat Hinge Shaft Retainer Clip Set

- 64-70 Set of 4 352358-SK

FRONT SEAT WASHER



Install on seat hinge shaft between the seat and hinge to prevent

hinge from wearing through upholstery.

Front Seat Washer

- 65-73 Set of 4 373249-S

SEAT ADJUSTER KNOB



Knob to adjust forward and back motion of seat slider.

Seat Adjuster Knob

- 65-72 C5AZ-6261753-BA

WE PROUDLY FEATURE AUTHENTIC MUSTANG REPRODUCTIONS FROM SCOTT DRAKE ENTERPRISES!



SEAT BACK ADJUSTING KIT

Includes pair of chrome screw adjusters, nuts and washers, heavy duty plastic rest plates and attaching screws.

Seat Back Adjusting Kit

64-67 C1DZ-6461643

SEAT LATCH HANDLE & BEZEL SET

Exact detail and beautiful chrome. These handles & bezels are commonly pitted, broken or missing. Our 6 piece kit does both front seats.

Seat Latch Handle and Bezel Set

68-69
C8AZ6262622/72A

70-73
C9AZ-626262272A

HEAD REST

These headrest makes retrofitting original Mustang seat to head rest types possible.

Kit includes color keyed head rest, mounting brackets, hardware and instructions.

Head Rest

64-67 std., dark black	HR-BK
64-67 std., dark blue	HR-BL
64-67 std., bright red	HR-BR
64-67 std., dark red	HR-DR
64-67 std., ivy gold	HR-IG
64-67 std., light blue	HR-LB
64-67 std., palomino	HR-PA
64-67 std., parchment	HR-PR
64-67 std., saddle	HR-SA
64-67 std., white	HR-WT
65-67 std., aqua	HR-AQ
65-67 Sport seat, aqua	SS-HR-AQ
65-67 Sport seat, black	SS-HR-BK
65-67 Sport seat, light blue	SS-HR-BL
65-67 Sport seat, bright red	SS-HR-BR
65-67 Sport seat, dark red	SS-HR-DR
65-67 Sport seat, ivy gold	SS-HR-IG
65-67 Sport seat, palomino	SS-HR-PA
65-67 Sport seat, parchment	SS-HR-PR
65-67 Sport seat, white	SS-HR-WT

SEAT BOTTOM FRAME

The bottom frame and spring assembly for the bucket seat Complete seat frames available Jan 2009.

Seat Bottom Frame

64-67 RH CSZZ-6563100-A
64-67 LH CSZZ-6563101-A

SEAT BUTTON

Die casted like the originals. For deluxe interiors. New lower prices!

Seat Button

67: dlx., button only (4 req. per car)

C7ZB-6564824-B

67: dlx., inc. back plate (4 req. per car)

C7ZB-6564824-K



68: dlx., button only (8 req. per car)

C8ZB-6564824-A

68: dlx., inc. back plate (8 req. per car)

C8ZB-6564824-K



69-70: dlx., teak & walnut (69 cars req. 4 pairs, 70 cars require 5 pairs)

C9ZZ-6564824-W

SEAT HINGE COVER

These hinge covers are exact copies of the originals. Exterior molded plastic.

Seat Hinge Cover

64-67: Black

C5ZZ-6561692/3B

64-67: Neutral

C5ZZ-6561692/3N



68-70: Black

C8AZ-6561692/5B

68-70: Neutral

C8AZ-6561692/5N

SEAT HINGE REPAIR BRACKET

A very common breaking point can now be easily repaired.

Seat Hinge Repair Bracket

68-70 Inner, LH D7ZZ-69618C46-A

ALUMINUM SEAT SIDE MOLDING

Stamped aluminum as originals, clear anodized plated. Will fit 1967 but must redrill lower hole on seat frame. Look for

correct 1967 version early 2009.

Seat Side Molding, Aluminum

65-66 RH CSZZ-6561616-AR

65-66 LH CSZZ-6561617-AR

FIBERGLASS SEAT SIDE MOLDING

Nice quality fiber glass reproductions to replace commonly broken moldings. No hardware or brackets included. Paint to match

Seat Side Molding, Fiberglass

67 Pair C7ZZ-6567186/7

SEAT SIDE MOLDING MOUNT KIT

This kit contains all the original style parts to mount the seat side molding. Does one seat.

Seat Side Molding Mount Kit

65-66 6 pieces CSZZ-65616167MK

67 6 pieces C7ZZ-65616167MK

SEAT STOP BUMPER KIT

These seat bumpers install between the seat cushion and seat back. Fits many other Ford/Mercury seats.

Seat Stop Bumper Kit

68-73 C8ZZ-6560310/1

SEAT TRACK ASSEMBLY

These replacement seat track assemblies come with everything necessary to replace those hard to move or broken originals. Each

set does one seat.

Seat Track Assembly

64-68 CSZZ-6561704/5

69-70 C9ZZ-6561704/5

SEAT TRACK PLATE

Heavy steel plates, stamped in the original gauge steel. Painted black, sold individually or in sets of eight.

Seat Track Plate

64-67 Bulk CSZZ-13190-A

64-67 Set of 8 CSZZ-13190-K

SEAT TRACK SPRING SET

Includes all the springs necessary to rebuild one seat. Black phosphorous plated.

Seat Track Spring Set

64-70 CSZZ-6561828/83

HOG RING KIT

Our hog ring installation kits each feature pliers and 150 hog rings included (enough for 1 seat).

Hog Ring Kit

64-73 Economy, simple pliers PLIERSET-P

64-73 Medium, upgrade cast pliers PLIERSET-P

64-73 Pro, spring-loaded pliers PLIERSET-P

SEATS & UPHOLSTERY

STANDARD FULL SET SEAT UPHOLSTERY



These are complete seat upholstery sets for Mustangs with standard bucket seats. Ours are the best on the market, precision

made from the same heavy duty vinyl and attention to detail originally used by Ford. Our custom colors are an exact match. Heavy 32 ounce vinyl and solid welt cord. Patterns are die cut for precision. In the case of Pony patterns, they have the same detail as the originals. Kits do not include hog rings for installation.

Full Set Seat Upholstery, Standard

64-65	std., CP, black65CP-S-FULL-BK
64-65	std., CP, blue65CP-S-FULL-BL
64-65	std., CP, bright red65CP-S-FULL-BR
64-65	std., CP, ivy gold65CP-S-FULL-IG
64-65	std., CP, palomino65CP-S-FULL-PA
64-65	std., CP, white65CP-S-FULL-WT
64-65	std., CV, black65CV-S-FULL-BK
64-65	std., CV, blue65CV-S-FULL-BL
64-65	std., CV, bright red65CV-S-FULL-BR
64-65	std., CV, ivy gold65CV-S-FULL-IG
64-65	std., CV, palomino65CV-S-FULL-PA
64-65	std., CV, white65CV-S-FULL-WT
65	std., FB, black65FB-S-FULL-BK
65	std., FB, blue65FB-S-FULL-BL
65	std., FB, bright red65FB-S-FULL-BR
65	std., FB, ivy gold65FB-S-FULL-IG
65	std., FB, palomino65FB-S-FULL-PA
65	std., FB, white65FB-S-FULL-WT
66	std., CP, aqua66CP-S-FULL-AQ
66	std., CP, black66CP-S-FULL-BK
66	std., CP, blue66CP-S-FULL-BL
66	std., CP, dark red66CP-S-FULL-DR
66	std., CP, parchment66CP-S-FULL-PR
66	std., CV, aqua66CV-S-FULL-AQ
66	std., CV, black66CV-S-FULL-BK
66	std., CV, blue66CV-S-FULL-BL
66	std., CV, dark red66CV-S-FULL-DR
66	std., CV, parchment66CV-S-FULL-PR
66	std., FB, aqua66FB-S-FULL-AQ
66	std., FB, black66FB-S-FULL-BK
66	std., FB, blue66FB-S-FULL-BL
66	std., FB, dark red66FB-S-FULL-DR
66	std., FB, parchment66FB-S-FULL-PR
67	std., CP, aqua67CP-S-FULL-AQ
67	std., CP, black67CP-S-FULL-BK
67	std., CP, blue67CP-S-FULL-BL
67	std., CP, dark red67CP-S-FULL-DR
67	std., CP, ivy gold67CP-S-FULL-IG
67	std., CP, parchment67CP-S-FULL-PR
67	std., CP, saddle67CP-S-FULL-SA
67	std., CV, aqua67CV-S-FULL-AQ

Full Set Seat Upholstery, Standard

67	std., CV, black67CV-S-FULL-BK
67	std., CV, blue67CV-S-FULL-BL
67	std., CV, dark red67CV-S-FULL-DR
67	std., CV, ivy gold67CV-S-FULL-IG
67	std., CV, parchment67CV-S-FULL-PR
67	std., CV, saddle67CV-S-FULL-SA
67	std., FB, aqua67FB-S-FULL-AQ
67	std., FB, black67FB-S-FULL-BK
67	std., FB, blue67FB-S-FULL-BL
67	std., FB, dark red67FB-S-FULL-DR
67	std., FB, ivy gold67FB-S-FULL-IG
67	std., FB, parchment67FB-S-FULL-PR
67	std., FB, saddle67FB-S-FULL-SA
68	std., CP, aqua68CP-S-FULL-AQ
68	std., CP, black68CP-S-FULL-BK
68	std., CP, blue68CP-S-FULL-BL
68	std., CP, ivy gold68CP-S-FULL-IG
68	std., CP, maroon68CP-S-FULL-MR
68	std., CP, nugget gold68CP-S-FULL-NG
68	std., CP, parchment68CP-S-FULL-PR
68	std., CP, saddle68CP-S-FULL-SA
68	std., CV, aqua68CV-S-FULL-AQ
68	std., CV, black68CV-S-FULL-BK
68	std., CV, blue68CV-S-FULL-BL
68	std., CV, ivy gold68CV-S-FULL-IG
68	std., CV, maroon68CV-S-FULL-MR
68	std., CV, nugget gold68CV-S-FULL-NG
68	std., CV, parchment68CV-S-FULL-PR
68	std., CV, saddle68CV-S-FULL-SA
68	std., FB, aqua68FB-S-FULL-AQ
68	std., FB, black68FB-S-FULL-BK
68	std., FB, blue68FB-S-FULL-BL
68	std., FB, ivy gold68FB-S-FULL-IG
68	std., FB, maroon68FB-S-FULL-MR
68	std., FB, nugget gold68FB-S-FULL-NG
68	std., FB, parchment68FB-S-FULL-PR
68	std., FB, saddle68FB-S-FULL-SA
69	std., CP, black69CP-S-FULL-BK
69	std., CP, dark red69CP-S-FULL-DR
69	std., CP, ivy gold69CP-S-FULL-IG
69	std., CP, light blue69CP-S-FULL-LB
69	std., CP, nugget gold69CP-S-FULL-NG
69	std., CP, white69CP-S-FULL-WT
69	std., CV, black69CV-S-FULL-BK
69	std., CV, dark red69CV-S-FULL-DR
69	std., CV, ivy gold69CV-S-FULL-IG
69	std., CV, light blue69CV-S-FULL-LB
69	std., CV, nugget gold69CV-S-FULL-NG
69	std., FB, black69FB-S-FULL-BK
69	std., FB, dark red69FB-S-FULL-DR
69	std., FB, ivy gold69FB-S-FULL-IG
69	std., FB, light blue69FB-S-FULL-LB
69	std., FB, nugget gold69FB-S-FULL-NG
70	std., CP, black70CP-S-FULL-BK
70	std., CP, blue70CP-S-FULL-BL
70	std., CP, ginger70CP-S-FULL-GI
70	std., CP, ivy gold70CP-S-FULL-IV
70	std., CP, vermilion70CP-S-FULL-VE
70	std., CV, white70CP-S-FULL-WT

Full Set Seat Upholstery, Standard

70	std., CV, black70CV-S-FULL-BK
70	std., CV, blue70CV-S-FULL-BL
70	std., CV, ginger70CV-S-FULL-GI
70	std., CV, ivy gold70CV-S-FULL-IV
70	std., CV, vermilion70CV-S-FULL-VE
70	std., CV, white70CV-S-FULL-WT
70	std., FB, black70FB-S-FULL-BK
70	std., FB, blue70FB-S-FULL-BL
70	std., FB, ginger70FB-S-FULL-GI
70	std., FB, ivy gold70FB-S-FULL-IV
70	std., FB, vermilion70FB-S-FULL-VE
70	std., FB, white70FB-S-FULL-WT
71	std., CP, vermilion71CP-S-FULL-VE
71	std., CV, black71CV-S-FULL-BK
71	std., CV, blue71CV-S-FULL-BL
71	std., CV, ginger71CV-S-FULL-GI
71	std., CV, green71CV-S-FULL-GR
71	std., CV, vermilion71CV-S-FULL-VE
71	std., CV, white71CV-S-FULL-WT
71-73	std., CP, black71CP-S-FULL-BK
71-73	std., CP, blue71CP-S-FULL-BL
71-73	std., CP, ginger71CP-S-FULL-GI
71-73	std., CP, green71CP-S-FULL-GR
71-73	std., CP, white71CP-S-FULL-WT
71-73	std., FB, black71FB-S-FULL-BK
71-73	std., FB, blue71FB-S-FULL-BL
71-73	std., FB, ginger71FB-S-FULL-GI
71-73	std., FB, green71FB-S-FULL-GR
71-73	std., FB, vermilion71FB-S-FULL-VE
71-73	std., FB, white71FB-S-FULL-WT

BENCH FULL SET SEAT UPHOLSTERY



These are complete seat upholstery sets for Mustangs with a bench seat. Ours are the best on the market, precision

made from the same heavy duty vinyl and attention to detail originally used by Ford. Our custom colors are an exact match. Heavy 32 ounce vinyl and solid welt cord. Patterns are die cut for precision. In the case of Pony patterns, they have the same detail as the originals. Kits do not include hog rings for installation.

Full Set Seat Upholstery, Bench

65	Bench, CP, black65CP-B-FULL-BK
65	Bench, CP, blue65CP-B-FULL-BL
65	Bench, CP, bright red65CP-B-FULL-BR
65	Bench, CP, ivy gold65CP-B-FULL-IG
65	Bench, CP, palomino65CP-B-FULL-PA
65	Bench, CP, white65CP-B-FULL-WT
65	Bench, CV, black65CV-B-FULL-BK
65	Bench, CV, blue65CV-B-FULL-BL
65	Bench, CV, bright red65CV-B-FULL-BR
65	Bench, CV, ivy gold65CV-B-FULL-IG
65	Bench, CV, palomino65CV-B-FULL-PA
65	Bench, CV, white65CV-B-FULL-WT

Continued on next page

WE PROUDLY FEATURE AUTHENTIC MUSTANG REPRODUCTIONS FROM SCOTT DRAKE ENTERPRISES!



Full Set Seat Upholstery, Bench

66	Bench, CP, aqua	66CP-B-FULL-AQ
66	Bench, CP, black	66CP-B-FULL-BK
66	Bench, CP, blue	66CP-B-FULL-BL
66	Bench, CP, dark red	66CP-B-FULL-DR
66	Bench, CP, parchment	66CP-B-FULL-PR
66	Bench, CV, aqua	66CV-B-FULL-AQ
66	Bench, CV, black	66CV-B-FULL-BK
66	Bench, CV, blue	66CV-B-FULL-BL
66	Bench, CV, dark red	66CV-B-FULL-DR
66	Bench, CV, parchment	66CV-B-FULL-PR
67	Bench, CP, aqua	67CP-B-FULL-AQ
67	Bench, CP, black	67CP-B-FULL-BK
67	Bench, CP, blue	67CP-B-FULL-BL
67	Bench, CP, dark red	67CP-B-FULL-DR
67	Bench, CP, ivy gold	67CP-B-FULL-IG
67	Bench, CP, parchment	67CP-B-FULL-PR
67	Bench, CP, saddle	67CP-B-FULL-SA
67	Bench, CV, aqua	67CV-B-FULL-AQ
67	Bench, CV, black	67CV-B-FULL-BK
67	Bench, CV, blue	67CV-B-FULL-BL
67	Bench, CV, dark red	67CV-B-FULL-DR
67	Bench, CV, ivy gold	67CV-B-FULL-IG
67	Bench, CV, parchment	67CV-B-FULL-PR
67	Bench, CV, saddle	67CV-B-FULL-SA
68	Bench, CP, aqua	68CP-B-FULL-AQ
68	Bench, CP, black	68CP-B-FULL-BK
68	Bench, CP, blue	68CP-B-FULL-BL
68	Bench, CP, ivy gold	68CP-B-FULL-IG
68	Bench, CP, maroon	68CP-B-FULL-MR
68	Bench, CP, nugget gold	68CP-B-FULL-NG
68	Bench, CP, parchment	68CP-B-FULL-PR
68	Bench, CP, saddle	68CP-B-FULL-SA
68	Bench, FB, aqua	68FB-B-FULL-AQ
68	Bench, FB, black	68FB-B-FULL-BK
68	Bench, FB, blue	68FB-B-FULL-BL
68	Bench, FB, ivy gold	68FB-B-FULL-IG
68	Bench, FB, maroon	68FB-B-FULL-MR
68	Bench, FB, nugget gold	68FB-B-FULL-NG
68	Bench, FB, parchment	68FB-B-FULL-PR
68	Bench, FB, saddle	68FB-B-FULL-SA
69	Bench, CP, black	69CP-B-FULL-BK
69	Bench, CP, dark red	69CP-B-FULL-DR
69	Bench, CP, ivy gold	69CP-B-FULL-IG
69	Bench, CP, light blue	69CP-B-FULL-LB
69	Bench, CP, nugget gold	69CP-B-FULL-NG

PONY FULL SET SEAT UPHOLSTERY



These are complete seat upholstery sets for 64-66 Mustangs with Pony Interiors. Ours are the best on the market, precision made from the same heavy duty vinyl and attention to detail originally used by Ford. Our custom colors are an exact match. Heavy 32 ounce vinyl and solid welt cord. Patterns are die cut for precision. In the case of Pony patterns, they have the same detail as the originals. Kits do not include hog rings for installation.

Full Set Seat Upholstery, Pony

65	Pony, CP, black/white	65CP-P-FULL-B/W
65	Pony, CP, black	65CP-P-FULL-BK
65	Pony, CP, blue/white	65CP-P-FULL-BL
65	Pony, CP, bright red	65CP-P-FULL-BR
65	Pony, CP, ivy gold/white	65CP-P-FULL-IG
65	Pony, CP, palomino	65CP-P-FULL-PA
65	Pony, CP, red/white	65CP-P-FULL-R/W
65	Pony, CP, white	65CP-P-FULL-WT
65	Pony, CV, bright red	65CV-P-FULL-BR
65	Pony, CV, palomino	65CV-P-FULL-PA
65	Pony, CV, bright red/white	65CV-P-FULL-R/W
65	Pony, CV, white	65CV-P-FULL-WT
65	Pony, FB, red	65FB-P-FULL-BR
65	Pony, FB, palomino	65FB-P-FULL-PA
65	Pony, FB, red/white	65FB-P-FULL-R/W
65	Pony, FB, white	65FB-P-FULL-WT
65-66	Pony, CV, black/white	65CV-P-FULL-B/W
65-66	Pony, CV, black	65CV-P-FULL-BK
65-66	Pony, CV, blue/white	65CV-P-FULL-BL
65-66	Pony, CV, ivy gold/white	65CV-P-FULL-IG
65-66	Pony, FB, black/white	65FB-P-FULL-B/W
65-66	Pony, FB, black	65FB-P-FULL-BK
65-66	Pony, FB, blue/white	65FB-P-FULL-BL
65-66	Pony, FB, ivy gold/white	65FB-P-FULL-IG
66	Pony, CP, aqua/white	66CP-P-FULL-AQ
66	Pony, CP, dark red	66CP-P-FULL-DR
66	Pony, CP, emberglo/parchment	66CP-P-FULL-EM
66	Pony, CP, parchment	66CP-P-FULL-PR
66	Pony, CP, dark red/white	66CP-P-FULL-R/W
66	Pony, CV, aqua/white	66CV-P-FULL-AQ
66	Pony, CV, dark red	66CV-P-FULL-DR
66	Pony, CV, emberblo/parchment	66CV-P-FULL-EM
66	Pony, CV, parchment	66CV-P-FULL-PR
66	Pony, CV, dark red/white	66CV-P-FULL-R/W
66	Pony, FB, aqua/white	66FB-P-FULL-AQ
66	Pony, FB, dark red	66FB-P-FULL-DR
66	Pony, FB, emberglo/parchment	66FB-P-FULL-EM
66	Pony, FB, parchment	66FB-P-FULL-PR
66	Pony, FB, dark red/white	66FB-P-FULL-R/W

SPORT SEAT FULL SET SEAT UPHOLSTERY



These Sport Seats are designed to replace the original 1965-67 upholstery and combine racy looks with comfort, performance and superior support. Available as a full upholstery set, or with front seat upholstery only. New Sport Seat foam is required (See

C5Z26560050/1SS). Headrests are sold separately. Matching door panels are also available.

Full Set Seat Upholstery, Sport Seat

65-67 Sport seats, Pony, CP, black	SS-65CP-FULL-BK
65-67 Sport seats, Pony, CP, blue	SS-65CP-FULL-BL
65-67 Sport seats, Pony, CP, bright red	SS-65CP-FULL-BR
65-67 Sport seats, Pony, CP, ivy gold	SS-65CP-FULL-IG
65-67 Sport seats, Pony, CP, palomino	SS-65CP-FULL-PA
65-67 Sport seats, Pony, CP, red/white	SS-65CP-FULL-RW
65-67 Sport seats, Pony, CP, white	SS-65CP-FULL-WT
65-67 Sport seats, Pony, CV, black	SS-65CV-FULL-BK
65-67 Sport seats, Pony, CV, blue	SS-65CV-FULL-BL
65-67 Sport seats, Pony, CV, bright red	SS-65CV-FULL-BR
65-67 Sport seats, Pony, CV, ivy gold	SS-65CV-FULL-IG
65-67 Sport seats, Pony, CV, palomino	SS-65CV-FULL-PA
65-67 Sport seats, Pony, CV, red/white	SS-65CV-FULL-RW
65-67 Sport seats, Pony, CV, white	SS-65CV-FULL-WT
65-67 Sport seats, Pony, CP, aqua	SS-66CP-FULL-AQ
65-67 Sport seats, Pony, CP, dark red	SS-66CP-FULL-DR
65-67 Sport seats, Pony, CP, emberglow	SS-66CP-FULL-EM
65-67 Sport seats, Pony, CP, parchment	SS-66CP-FULL-PR
65-67 Sport seats, Pony, CP, red/white	SS-66CP-FULL-RW
65-67 Sport seats, Pony, CV, aqua	SS-66CV-FULL-AQ
65-67 Sport seats, Pony, CV, dark red	SS-66CV-FULL-DR
65-67 Sport seats, Pony, CV, emberglow	SS-66CV-FULL-EM
65-67 Sport seats, Pony, CV, parchment	SS-66CV-FULL-PR
65-67 Sport seats, Pony, CV, dark red/white	SS-66CV-FULL-RW
65-67 Sport seats, std., CV, aqua	SS-67CV-FULL-AQ
65-67 Sport seats, std., CV, black	SS-67CV-FULL-BK
65-67 Sport seats, std., CV, blue	SS-67CV-FULL-BL
65-67 Sport seats, std., CV, dark red	SS-67CV-FULL-DR
65-67 Sport seats, std., CV, ivy gold	SS-67CV-FULL-IG
65-67 Sport seats, std., CV, parchment	SS-67CV-FULL-PR
65-67 Sport seats, std., CV, saddle	SS-67CV-FULL-SA
66-67 Sport seats, std., CP, dark red	SS-67CP-FULL-DR
67 Sport seats, std., CP, aqua	SS-67CP-FULL-AQ
67 Sport seats, std., CP, black	SS-67CP-FULL-BK
67 Sport seats, std., CP, blue	SS-67CP-FULL-BL
67 Sport seats, std., CP, ivy gold	SS-67CP-FULL-IG
67 Sport seats, std., CP, parchment	SS-67CP-FULL-PR
67 Sport seats, std., CP, saddle	SS-67CP-FULL-SA
67 Sport seats, std., FB, aqua	SS-67FB-FULL-AQ
67 Sport seats, std., FB, black	SS-67FB-FULL-BK
67 Sport seats, std., FB, blue	SS-67FB-FULL-BL
67 Sport seats, std., FB, dark red	SS-67FB-FULL-DR
67 Sport seats, std., FB, ivy gold	SS-67FB-FULL-IG
67 Sport seats, std., FB, parchment	SS-67FB-FULL-PR
67 Sport seats, std., FB, saddle	SS-67FB-FULL-SA
69-70 Sports seats Mach 1, special order special year & colors	SS-69-M-FULL-SO

DELUXE FULL SET SEAT UPHOLSTERY



These are complete seat upholstery sets for 68-73 Mustangs with deluxe interiors. Ours are the best on the market, precision made from the same heavy duty vinyl and attention to detail originally used by Ford. Our custom colors are an exact match.

Heavy 32 ounce vinyl and solid welt cord. Patterns are die cut for precision. In the case of Pony patterns, they have the same detail as the originals. Kits do not include hog rings for installation. Seat buttons sold separately.

Full Set Seat Upholstery, Deluxe

68 dlx., FB, black w/ comfortweave	68FB-D-FULL-BK
69 dlx., CP, black	69CP-D-FULL-BK
69 dlx., CP, dark red	69CP-D-FULL-DR
69 dlx., CP, ivy gold	69CP-D-FULL-IG
69 dlx., CP, light blue	69CP-D-FULL-LB
69 dlx., CP, nugget gold	69CP-D-FULL-NG
69 dlx., CP, white	69CP-D-FULL-WT
69 dlx., CV, black	69CV-D-FULL-BK
69 dlx., CV, dark red	69CV-D-FULL-DR
69 dlx., CV, ivy gold	69CV-D-FULL-IG
69 dlx., CV, light blue	69CV-D-FULL-LB
69 dlx., CV, nugget gold	69CV-D-FULL-NG
69 dlx., CV, white	69CV-D-FULL-WT
69 dlx., FB, black	69FB-D-FULL-BK
69 dlx., FB, dark red	69FB-D-FULL-DR
69 dlx., FB, ivy gold	69FB-D-FULL-IG
69 dlx., FB, light blue	69FB-D-FULL-LB
69 dlx., FB, nugget gold	69FB-D-FULL-NG
69 dlx., FB, white	69FB-D-FULL-WT
70 dlx., CP, black	70CP-D-FULL-BK
70 dlx., CP, blue	70CP-D-FULL-BL
70 dlx., CP, ginger	70CP-D-FULL-GI
70 dlx., CP, ivy gold	70CP-D-FULL-IG
70 dlx., CP, vermilion	70CP-D-FULL-VE
70 dlx., CP, white	70CP-D-FULL-WT
70 dlx., CV, black	70CV-D-FULL-BK
70 dlx., CV, blue	70CV-D-FULL-BL
70 dlx., CV, ginger	70CV-D-FULL-GI
70 dlx., CV, ivy gold	70CV-D-FULL-IG
70 dlx., CV, vermilion	70CV-D-FULL-VE
70 dlx., CV, white	70CV-D-FULL-WT
70 dlx., FB, black	70FB-D-FULL-BK
70 dlx., FB, blue	70FB-D-FULL-BL
70 dlx., FB, ginger	70FB-D-FULL-GI
70 dlx., FB, ivy gold	70FB-D-FULL-IG
70 dlx., FB, vermilion	70FB-D-FULL-VE
70 dlx., FB, white	70FB-D-FULL-WT
71 dlx., CP, black	71CP-D-FULL-BK
71 dlx., CP, blue	71CP-D-FULL-BL
71 dlx., CP, ginger	71CP-D-FULL-GI
71 dlx., CP, green	71CP-D-FULL-GR
71 dlx., CP, vermilion	71CP-D-FULL-VE
71 dlx., CP, white	71CP-D-FULL-WT
71 dlx., CV, black	71CV-D-FULL-BK
71 dlx., CV, blue	71CV-D-FULL-BL
71 dlx., CV, ginger	71CV-D-FULL-GI
71 dlx., CV, green	71CV-D-FULL-GR
71 dlx., CV, vermilion	71CV-D-FULL-VE
71 dlx., CV, white	71CV-D-FULL-WT

Continued on next page

WE PROUDLY FEATURE AUTHENTIC MUSTANG REPRODUCTIONS FROM SCOTT DRAKE ENTERPRISES!



Full Set Seat Upholstery, Deluxe

71	dlx., FB, black	71FB-D-FULL-BK
71	dlx., FB, blue	71FB-D-FULL-BL
71	dlx., FB, ginger	71FB-D-FULL-GI
71	dlx., FB, green	71FB-D-FULL-GR
71	dlx., FB, vermilion	71FB-D-FULL-VE
71	dlx., FB, white	71FB-D-FULL-WT
72-73	dlx., CP, black	72CP-D-FULL-BK
72-73	dlx., CP, blue	72CP-D-FULL-BL
72-73	dlx., CP, ginger	72CP-D-FULL-GI
72-73	dlx., CP, green	72CP-D-FULL-GR
72-73	dlx., CP, vermilion	72CP-D-FULL-VE
72-73	dlx., CP, white	72CP-D-FULL-WT
72-73	dlx., CV, black	72CV-D-FULL-BK
72-73	dlx., CV, blue	72CV-D-FULL-BL
72-73	dlx., CV, ginger	72CV-D-FULL-GI
72-73	dlx., CV, green	72CV-D-FULL-GR
72-73	dlx., CV, vermilion	72CV-D-FULL-VE
72-73	dlx., CV, white	72CV-D-FULL-WT
72-73	dlx., FB, black	72FB-D-FULL-BK
72-73	dlx., FB, blue	72FB-D-FULL-BL
72-73	dlx., FB, ginger	72FB-D-FULL-GI
72-73	dlx., FB, green	72FB-D-FULL-GR
72-73	dlx., FB, vermilion	72FB-D-FULL-VE
72-73	dlx., FB, white	72FB-D-FULL-WT

MACH 1 FULL SET SEAT UPHOLSTERY



These are complete seat upholstery sets for 69-73 Mach 1 Mustangs. Our upholstery sets are the best on the market, precision made from the same heavy duty vinyl and attention to detail originally used by Ford. Our custom colors are an exact match.

Heavy 32 ounce vinyl and solid welt cord. Patterns are die cut for precision. Kits do not include hog rings for installation.

Full Set Seat Upholstery, Mach 1

69	Mach 1, black/black stripe	69-M-FULL-BK/BK
69	Mach 1, black/red stripe	69-M-FULL-BK/RD
69	Mach 1, blue/specify stripe	69-M-FULL-DB/ST
69	Mach 1, dark red/specify stripe	69-M-FULL-DR/ST
69	Mach 1, white/black stripe	69-M-FULL-WT/BK
69	Mach 1, white/red stripe	69-M-FULL-WT/RD
69	Mach 1, white/white stripe	69-M-FULL-WT/WT
70	Mach 1, black/black stripe	70-M-FULL-BK/BK
70	Mach 1, black/gray stripe	70-M-FULL-BK/GY
70	Mach 1, dark blue/specify stripe	70-M-FULL-DB/ST
70	Mach 1, dark red/specify stripe	70-M-FULL-DR/ST
70	Mach 1, white/gray stripe	70-M-FULL-WT/GY
70	Mach 1, white/white stripe	70-M-FULL-WT/WT
71	Mach 1, black/silver	71FB-M-FULL-BS
71	Mach 1, dark blue	71FB-M-FULL-DB
71	Mach 1, dark red	71FB-M-FULL-DR
71	Mach 1, ginger	71FB-M-FULL-GI
71	Mach 1, green	71FB-M-FULL-GR
71	Mach 1, vermilion	71FB-M-FULL-VE
71	Mach 1, white	71FB-M-FULL-WT
71-73	Mach 1, black	71FB-M-FULL-BK
71-73	Mach 1, black/red stripe	71-M-FULL-BK/RD
72-73	Mach 1, black	72FB-M-FULL-DB
72-73	Mach 1, dark red	72FB-M-FULL-DR
72-73	Mach 1, white	72FB-M-FULL-WT

GRANDE FULL SET SEAT UPHOLSTERY



These are complete seat upholstery sets for 69-71 Grande Mustangs. Ours are the best on the market, precision made from the same heavy duty vinyl and attention to detail originally used by Ford. Our custom colors are an exact match. Heavy 32 ounce vinyl and solid welt cord. Patterns are die cut for precision. These all come with comfortweave inserts. Rare cloth insert option is not available. Kits do not include hog rings for installation. Seat buttons sold separately.

These are complete seat upholstery sets for 69-71 Grande Mustangs. Ours are the best on the market, precision made from the same heavy duty vinyl and attention to detail originally used by Ford. Our custom colors are an exact match. Heavy 32 ounce vinyl and solid welt cord. Patterns are die cut for precision. These all come with comfortweave inserts. Rare cloth insert option is not available. Kits do not include hog rings for installation. Seat buttons sold separately.

Full Set Seat Upholstery, Grande

69	Grande, CP, black	69CP-G-FULL-BK
69	Grande, CP, dark red	69CP-G-FULL-DR
69	Grande, CP, ivy gold	69CP-G-FULL-IG
69	Grande, CP, light blue	69CP-G-FULL-LB
69	Grande, CP, nugget gold	69CP-G-FULL-NG
69	Grande, CP, white	69CP-G-FULL-WT
70	Grande, CP, black	70CP-G-FULL-BK
70	Grande, CP, blue	70CP-G-FULL-BL
70	Grande, CP, ginger	70CP-G-FULL-GI
70	Grande, CP, ivy gold	70CP-G-FULL-IG
70	Grande, CP, vermilion	70CP-G-FULL-VE
70	Grande, CP, white	70CP-G-FULL-WT
71	Grande, CP, black	71CP-G-FULL-BK
71	Grande, CP, blue	71CP-G-FULL-BL
71	Grande, CP, ginger	71CP-G-FULL-GI
71	Grande, CP, green	71CP-G-FULL-GR
71	Grande, CP, vermilion	71CP-G-FULL-VE
71	Grande, CP, white	71CP-G-FULL-WT

STANDARD FRONT SEAT ONLY UPHOLSTERY



These are front only seat upholstery sets for Mustangs with standard bucket seats. Ours are the best on the market, precision made from the same heavy duty vinyl and attention to detail originally used by Ford. Our custom colors are an exact match. Heavy 32 ounce vinyl and solid welt cord. Patterns are die cut for precision. In the case of Pony patterns, they have the same detail as the originals. Kits do not include hog rings for installation.

These are front only seat upholstery sets for Mustangs with standard bucket seats. Ours are the best on the market, precision made from the same heavy duty vinyl and attention to detail originally used by Ford. Our custom colors are an exact match. Heavy 32 ounce vinyl and solid welt cord. Patterns are die cut for precision. In the case of Pony patterns, they have the same detail as the originals. Kits do not include hog rings for installation.

Front Seat Only Upholstery, Standard

64-65	std., black, front only	65-S-BUCK-BK
64-65	std., blue, front only	65-S-BUCK-BL
64-65	std., bright red, front only	65-S-BUCK-BR
64-65	std., ivy gold, front only	65-S-BUCK-IG
64-65	std., palomino, front only	65-S-BUCK-PA
64-65	std., white, front only	65-S-BUCK-WT
66	std., aqua, front only	66-S-BUCK-AQ
66	std., black, front only	66-S-BUCK-BK
66	std., blue, front only	66-S-BUCK-BL
66	std., dark red, front only	66-S-BUCK-DR
66	std., parchment, front only	66-S-BUCK-PR
67	std., aqua, front only	67-S-BUCK-AQ
67	std., black, front only	67-S-BUCK-BK
67	std., blue, front only	67-S-BUCK-BL
67	std., dark red, front only	67-S-BUCK-DR
67	std., ivy gold, front only	67-S-BUCK-IG
67	std., parchment, front only	67-S-BUCK-PR
67	std., saddle, front only	67-S-BUCK-SA
68	std., aqua, front only	68-S-BUCK-AQ
68	std., black, front only	68-S-BUCK-BK

Continued on next page

SHOP WITH CONFIDENCE! WE OFFER SUPERIOR-QUALITY PARTS FOR ALL YOUR MUSTANG RESTORATION NEEDS.

Front Seat Only Upholstery, Standard

68	std., blue, front only	68-S-BUCK-BL
68	std., ivy gold, front only	68-S-BUCK-IG
68	std., maroon, front only	68-S-BUCK-MR
68	std., nugget gold, front only	68-S-BUCK-NG
68	std., parchment, front only	68-S-BUCK-PR
68	std., saddle, front only	68-S-BUCK-SA
69	std., black, front only	69-S-BUCK-BK
69	std., dark red, front only	69-S-BUCK-DR
69	std., ivy gold, front only	69-S-BUCK-IG
69	std., light blue, front only	69-S-BUCK-LB
69	std., nugget gold, front only	69-S-BUCK-NG
70	std., black, front only	70-S-BUCK-BK
70	std., blue, front only	70-S-BUCK-BL
70	std., ginger, front only	70-S-BUCK-GI
70	std., ivy gold, front only	70-S-BUCK-IV
70	std., vermillion, front only	70-S-BUCK-VE
70	std., white, front only	70-S-BUCK-WT
71-73	std., black, front only	71-S-BUCK-BK
71-73	std., blue, front only	71-S-BUCK-BL
71-73	std., ginger, front only	71-S-BUCK-GI
71-73	std., green, front only	71-S-BUCK-GR
71-73	std., vermillion, front only	71-S-BUCK-VE
71-73	std., white, front only	71-S-BUCK-WT

BENCH FRONT SEAT ONLY UPHOLSTERY



These are front only seat upholstery sets for Mustangs with a front bench seat. Our upholstery sets are the best on the market, precision made from the same heavy duty vinyl and attention to detail originally used by Ford. Our custom colors are an exact

match. Heavy 32 ounce vinyl and solid welt cord. Patterns are die cut for precision. Kits do not include hog rings for installation.

Front Seat Only Upholstery, Bench

65	Bench, black, front only	65-B-BENCH-BK
65	Bench, blue, front only	65-B-BENCH-BL
65	Bench, bright red, front only	65-B-BENCH-BR
65	Bench, ivy gold, front only	65-B-BENCH-IG
65	Bench, palomino, front only	65-B-BENCH-PA
65	Bench, white, front only	65-B-BENCH-WT
66	Bench, aqua, front only	66-B-BENCH-AQ
66	Bench, black, front only	66-B-BENCH-BK
66	Bench, blue, front only	66-B-BENCH-BL
66	Bench, dark red, front only	66-B-BENCH-DR
66	Bench, parchment, front only	66-B-BENCH-PR
67	Bench, aqua, front only	67-B-BENCH-AQ
67	Bench, black, front only	67-B-BENCH-BK
67	Bench, blue, front only	67-B-BENCH-BL
67	Bench, dark red, front only	67-B-BENCH-DR
67	Bench, ivy gold, front only	67-B-BENCH-IG
67	Bench, parchment, front only	67-B-BENCH-PR
67	Bench, saddle, front only	67-B-BENCH-SA
68	Bench, aqua, front only	68-B-BENCH-AQ
68	Bench, black, front only	68-B-BENCH-BK
68	Bench, blue, front only	68-B-BENCH-BL
68	Bench, ivy gold, front only	68-B-BENCH-IG
68	Bench, maroon, front only	68-B-BENCH-MR
68	Bench, nugget gold, front only	68-B-BENCH-NG
68	Bench, parchment, front only	68-B-BENCH-PR
68	Bench, saddle, front only	68-B-BENCH-SA
68	Bench, turquoise, front only	68-B-BENCH-TQ

PONY FRONT SEAT ONLY UPHOLSTERY



These are front only seat upholstery sets for 64-66 Mustangs with Pony Interiors. Ours are the best on the market, precision made from the same heavy duty vinyl and attention to detail originally used by Ford. Our custom colors are an exact match. Heavy 32 ounce vinyl and

solid welt cord. Patterns are die cut for precision. In the case of Pony patterns, they have the same detail as the originals. Kits do not include hog rings for installation.

Front Seat Only Upholstery, Pony

65	Pony, black, front only	65-P-BUCK-BK
65	Pony, blue/white, front only	65-P-BUCK-BL
65	Pony, bright red, front only	65-P-BUCK-BR
65	Pony, ivy gold/white, front only	65-P-BUCK-IG
65	Pony, palomino, front only	65-P-BUCK-PA
65	Pony, white, front only	65-P-BUCK-WT
66	Pony, aqua/white, front only	66-P-BUCK-AQ
66	Pony, dark red, front only	66-P-BUCK-DR
66	Pony, embergl/parchment, front only	66-P-BUCK-EM
66	Pony, parchment, front only	66-P-BUCK-PR

SPORT SEAT FRONT SEAT ONLY UPHOLSTERY



These Sport Seats are designed to replace the original 1965-67 upholstery and combine racy looks with comfort, performance and superior support. Available as a full upholstery set, or with front seat upholstery only. New Sport Seat foam is required (See C5ZZ6560050/1SS).

Headrests are sold separately. Matching door panels are also available.

Front Seat Only Upholstery, Sport Seat

65-67	Sport seats, Pony, black, front only	SS-65-P-BUCK-BK
65-67	Sport seats, Pony, blue, front only	SS-65-P-BUCK-BL
65-67	Sport seats, Pony, bright red, front only	SS-65-P-BUCK-BR
65-67	Sport seats, Pony, ivy gold, front only	SS-65-P-BUCK-IG
65-67	Sport seats, Pony, palomino, front only	SS-65-P-BUCK-PA
65-67	Sport seats, Pony, red/white, front only	SS-65-P-BUCK-RW
65-67	Sport seats, Pony, white, front only	SS-65-P-BUCK-WT
65-67	Sport seats, Pony, aqua/white, front only	SS-66-P-BUCK-AQ
65-67	Sport seats, Pony, dark red, front only	SS-66-P-BUCK-DR
65-67	Sport seats, Pony, red/white, front only	SS-66-P-BUCK-RW
65-67	Sport seats, std., aqua, front only	SS-67-S-BUCK-AQ
65-67	Sport seats, std., blue, front only	SS-67-S-BUCK-BL
65-67	Sport seats, std., ivy gold, front only	SS-67-S-BUCK-IG
65-67	Sport seats, std., parchment, front only	SS-67-S-BUCK-PR
65-67	Sport seats, std., saddle, front only	SS-67-S-BUCK-SA
67	Sport seats, std., black, front only	SS-67-S-BUCK-BK
69-70	Sports seat Mach 1, special order special year & colors	SS-69-M-BUCK-SO

WE PROUDLY FEATURE AUTHENTIC MUSTANG REPRODUCTIONS FROM SCOTT DRAKE ENTERPRISES!



DELUXE FRONT SEAT ONLY UPHOLSTERY



These are front only seat upholstery sets for 69-73 Mustangs with deluxe interiors. Ours are the best on the market, precision made from the same heavy duty vinyl and attention to detail originally used by Ford. Our custom colors are an exact match.

Heavy 32 ounce vinyl and solid welt cord. Patterns are die cut for precision. In the case of Pony patterns, they have the same detail as the originals. Kits do not include hog rings for installation. Seat buttons sold separately.

Front Seat Only Upholstery, Deluxe

69	dlx., black, front only	69-D-BUCK-BK
69	dlx., dark red, front only	69-D-BUCK-DR
69	dlx., ivy gold, front only	69-D-BUCK-IG
69	dlx., light blue, front only	69-D-BUCK-LB
69	dlx., nugget gold, front only	69-D-BUCK-NG
69	dlx., white, front only	69-D-BUCK-WT
70	dlx., black, front only	70-D-BUCK-BK
70	dlx., blue, front only	70-D-BUCK-BL
70	dlx., ginger, front only	70-D-BUCK-GI
70	dlx., ivy gold, front only	70-D-BUCK-IV
70	dlx., vermillion, front only	70-D-BUCK-VE
70	dlx., white, front only	70-D-BUCK-WT
71	dlx., black, front only	71-D-BUCK-BK
71	dlx., blue, front only	71-D-BUCK-BL
71	dlx., ginger, front only	71-D-BUCK-GI
71	dlx., green, front only	71-D-BUCK-GR
71	dlx., vermillion, front only	71-D-BUCK-VE
71	dlx., white, front only	71-D-BUCK-WT
72-73	dlx., black, front only	72-D-BUCK-BK
72-73	dlx., blue, front only	72-D-BUCK-BL
72-73	dlx., ginger, front only	72-D-BUCK-GI
72-73	dlx., green, front only	72-D-BUCK-GR
72-73	dlx., vermillion, front only	72-D-BUCK-VE
72-73	dlx., white, front only	72-D-BUCK-WT

MACH 1 FRONT SEAT ONLY UPHOLSTERY



These are front only seat upholstery sets for 69-73 Mach 1 Mustangs. Our upholstery sets are the best on the market, precision made from the same heavy duty vinyl and attention to detail originally used by Ford. Our custom colors are an exact match.

Heavy 32 ounce vinyl and solid welt cord. Patterns are die cut for precision. Kits do not include hog rings for installation.

Front Seat Only Upholstery, Mach 1

69	Mach 1, black/black stripe, front only	69-M-BUCK-BK/BK
69	Mach 1, black/red stripe, front only	69-M-BUCK-BK/RD
69	Mach 1, dark blue/specify stripe, front only	69-M-BUCK-DB/ST
69	Mach 1, dark red/specify stripe, front only	69-M-BUCK-DR/ST
69	Mach 1, white/red stripe, front only	69-M-BUCK-WT/RD
69	Mach 1, white/white stripe, front only	69-M-BUCK-WT/WT
70	Mach 1, black/gray stripe, front only	70-M-BUCK-BK/GY
70	Mach 1, dark blue/specify stripe, front only	70-M-BUCK-DB/ST
70	Mach 1, dark red/specify stripe, front only	70-M-BUCK-DR/ST
70	Mach 1, white/gray stripe, front only	70-M-BUCK-WT/GY
70	Mach 1, white/white stripe, front only	70-M-BUCK-WT/WT
71-73	Mach 1, black/gray stripe, front only	71-M-BUCK-BK/GR
71	Mach 1, black, front only	71-M-BUCK-BK
71	Mach 1, dark blue, front only	71-M-BUCK-DB
71	Mach 1, dark red, front only	71-M-BUCK-DR

Front Seat Only Upholstery, Mach 1

71-73	Mach 1, ginger, front only	71-M-BUCK-GI
71	Mach 1, white, front only	71-M-BUCK-WT
72-73	Mach 1, dark blue, front only	72-M-BUCK-DB
72-73	Mach 1, dark red, front only	72-M-BUCK-DR
72-73	Mach 1, white, front only	72-M-BUCK-WT

GRANDE FRONT SEAT ONLY UPHOLSTERY



These are front only seat upholstery sets for 69-71 Grande Mustangs. Ours are the best on the market, precision made from the same heavy duty vinyl and attention to detail originally used by Ford. Our custom colors are an exact match. Heavy 32 ounce vinyl and

solid welt cord. Patterns are die cut for precision. These all come with comfortweave inserts. Rare cloth insert option is not available. Kits do not include hog rings for installation. Seat buttons sold separately.

Front Seat Only Upholstery, Grande

69	Grande, black, front only	69-G-BUCK-BK
69	Grande, dark red, front only	69-G-BUCK-DR
69	Grande, ivy gold, front only	69-G-BUCK-IG
69	Grande, light blue, front only	69-G-BUCK-LB
69	Grande, nugget gold, front only	69-G-BUCK-NG
69	Grande, white, front only	69-G-BUCK-WT
70	Grande, black, front only	70-G-BUCK-BK
70	Grande, blue, front only	70-G-BUCK-BL
70	Grande, ginger, front only	70-G-BUCK-GI
70	Grande, ivy Gold, front only	70-G-BUCK-IV
70	Grande, vermillion, front only	70-G-BUCK-VE
70	Grande, white, front only	70-G-BUCK-WT
71	Grande, black, front only	71-G-BUCK-BK
71-73	Grande, blue, front only	71-G-BUCK-BL
71-73	Grande, ginger, front only	71-G-BUCK-GI
71-73	Grande, green, front only	71-G-BUCK-GR
71-73	Grande, vermillion, front only	71-G-BUCK-VE

FLO-FIT CUSTOM SEAT



The ultimate in comfort and safety without sacrificing that classic look. Flo-Fit is a leader in seating technology so you can be assured of the highest quality seats on the market.

- All new Flo-Fit frames and seat foams
- Special adapter plate for easy installation

- Fully assembled in OEM colors
- Authentic pony inserts
- Adjustable head rest for safety and comfort
- Adjustable leg extension
- Improved lumbar & thigh support
- Side Bolsters
- Fully reclining backrest

Seat, Flo-Fit Custom

64-73	High-back, Pony, black	FF-P-BK
64-73	High-back, Pony, blue/white	FF-P-BL
64-73	High-back, Pony, bright red	FF-P-BR
64-73	High-back, Pony, bright red/white	FF-P-BR/W
64-73	High-back, Pony, dark red	FF-P-DR
64-73	High-back, Pony, dark red/white	FF-P-DR/W
64-73	High-back, Pony, ivy gold/white	FF-P-IG
64-73	High-back, Pony, palomino	FF-P-PA
64-73	High-back, Pony, parchment	FF-P-PR
64-73	High-back, Pony, white	FF-P-WT

SHOP WITH CONFIDENCE! WE OFFER SUPERIOR-QUALITY PARTS FOR ALL YOUR MUSTANG RESTORATION NEEDS.

SEAT CUSHION



Replace your old worn out seat cushions. Excellent reproductions made from the same type of foam as the originals.

Seat Cushion

64-66	std.	C5ZZ-6560050/1S
65-66	Pony	C5ZZ-6560050/1P
67	std./dlx.	C7ZZ-6560050/1S
68	std./dlx.	C8ZZ-6560050/1S
69	std.	C9ZZ-6560050/1S
69-70	Highback, Mach 1, Shelby	C9ZZ-6560050/1M
70	Highback, std.	D0ZZ-6560050/1S
71-73	Highback, std.	D1ZZ-6560050/1S

SPORT SEAT SEAT CUSHION



These seat cushions feature larger upper and lower side bolsters for more comfort and to keep you firmly planted in your seat.

Must be used in conjunction with TMI's sport seat upholstery.

Seat Cushion, Sport Seat

65-67	Sport seat	C5ZZ6560050/1SS
69-70	Highback, sport	C9ZZ6560050/1SS

SHIFTER COMPONENTS

See the "Transmission" section, later in this catalog.

STEERING

See the "Steering" section, later in this catalog.

WE PROUDLY FEATURE AUTHENTIC MUSTANG REPRODUCTIONS FROM SCOTT DRAKE ENTERPRISES!



KEYS, LOCKS & LATCHES

DOOR & IGNITION LOCKS

DOOR HANDLE SHAFT ASSEMBLY



Gold cadmium plated to resist rust and corrosion. Rod retainers not included.

Door Handle Shaft Assembly

64-66 std., RH	C5ZZ-6521818-C
64-66 std., LH	C5ZZ-6521819-C
65-66 Pony, RH	C5ZZ-6521818-B
65-66 Pony, LH	C5ZZ-6521819-B
67-68 RH	C60Z-6221818-B
67-68 LH	C60Z-6221819-B

DOOR LATCH ASSEMBLY



Finally an affordable reproduction is available. Steel stamped complete latch.

Door Latch Assembly

65-66 RH	C4SZ-6321812-C
65-66 LH	C4SZ-6321813-C
67-68 RH	C60Z-6221812-A
67-68 LH	C60Z-6221813-A
69-70 RH	C9AZ-6221812-A
69-70 LH	C9AZ-6221813-A

DOOR LATCH LOCK ROD



Set of three Door Lock Rods. Zinc plated for years of service.

Door Latch Lock Rod

65-66 LH, set of 3	C5ZZ-65213452LH
65-66 RH, set of 3	C5ZZ-65213452RH
67-68 LH, set of 3	C7ZZ-65213452LH
67-68 RH, set of 3	C7ZZ-65213452RH

DOOR LATCH PLATE REPAIR KIT



Easily repairs cracked door latch mounting holes. Includes mounting screws.

Door Latch Plate Repair Kit

64-66	C5ZZ-6528160/1A
67-68	C7ZZ-6528160/1A

DOOR LATCH RETAINER BUSHING



Door Latch Retainer Bushing. 4 piece kit.

Door Latch Retainer Bushing

64-66	C4SZ-6321801-C
-------	-------	----------------

DOOR LATCH ROD RETAINER

This is the original, concours type door rod retainer that connect the four rods to the latch and lock assemblies inside the doors. There are six of these used in each door.

Door Latch Rod Retainer



64-66: Concours
C3AZ-6221952-AR



65-66: White economy replacement
C3AZ-6221952-A



67-73: Concours
C5AZ-6221952-AR

DOOR LOCK CYLINDER RETAINER



Original clips from the O.E.M. supplier to Ford, assuring you of a quality part.

Door Lock Cylinder Retainer

67-80	C5AZ-6222023-A
-------	-------	----------------

DOOR LOCK KNOB



Made by Plastic injection. Sold as a pair. Available in chrome or satin chrome.

Door Lock Knob

64-66 Chrome	C5DZ-6221850-A
64-66 Satin chrome	C5DZ-6221850-S
67 Chrome	C5AZ-6221850-A
68-73 Chrome	C8AZ-6221850-A

DOOR LOCK KNOB GROMMET

The grommet that goes around the door lock knob, comes in clear, chrome or stainless.

Door Lock Knob Grommet



65-68 All,
69-73 std. int.: Clear plastic
C5DZ-6221999-B



65-68 All,
69-73 std. int.: Chrome
C5DZ-6221999-C



69-73: stainless, dlx. int.
D0DZ-6221999-AR

DOOR STRIKER ASSEMBLY

Original factory type striker. Includes attaching parts.

Door Striker Assembly



64-66: Gold zinc
C20Z-6222008-B



67-70: Silver zinc, date coded 8-66
C5AZ-6222008-A



68-70: Silver zinc, date coded 11-67
C5AZ-6222008-B



71-80: Silver zinc
D2AZ-6522008-A

DOOR STRIKER PLATE SCREW



Four gold cadmium plated screws to attach door strikers to 1964 through 1970 Mustangs.

Door Striker Plate Screw

64-70 Set of 4	378428-S
----------------	-------	----------

IGNITION CYLINDER AND KEYS



Our ignition lock sets are all new. Two keys included.

Ignition Cylinder And Keys

64-66	C50Z-11582-A
67-69	C9AZ-11582-A
71-73	D2AZ-11582-B
73-76	D4AZ-11582-A

IGNITION SWITCH BEZEL

A perfect reproduction with concours chrome.

Ignition Switch Bezel



64-66
C3AZ-11584-A



67-68
C60Z-11584-A



69
C9AZ-11584-A

IGNITION SWITCH RETAINER

A "must have" part when installing an ignition switch. Zinc plated for years of service. Ignition Switch Retainer



64-66
C4DZ-10A885-A



67-68
C7ZZ-11A590-B

DOOR LOCK KIT



These door lock cylinders assure your customers of a durable part and a perfect fit. Available in pairs only.

Lock Kit, Door
67-73 D2AZ-6521984-A

DOOR & IGNITION LOCK KIT



Convenient matched kits save costly locksmith work. Kits include a pair of door lock cylinders and an ignition cylinder.

Comes with two keys. 1967 - 1969 include door cylinder gaskets.

Lock Kit, Door & Ignition
64-66 std. keys C5DZ-6222050-A
65-66 Pony keys C5DZ-6222050-B
67-69 C9AZ-6222050-A
70-73 D2AZ-6222050-A

MULTIPLE DOOR & IGNITION LOCK KITS



Multiple Mustang owners, simplify your life with these matched sets for either 2 or 3 cars. 1 single key will start up to 3

cars and open 6 doors. No more grabbing the wrong keys or fumbling through multiple keys trying to open a door or start a car. You also don't need to worry about a spare. These kits come with either 4 or 6 matched keys. So there is plenty for all the family to have one and a hidden key as well.

Lock Kits, Multiple Door & Ignition
64-66 2 cars C5DZ-6222050-2
64-66 3 cars C5DZ-6222050-3
67-69 2 cars C9AZ-6222050-2
67-69 3 cars C9AZ-6222050-3

DOOR, IGNITION & TRUNK LOCK KIT



Our quality lock set with all locks keyed the same. No separate trunk lock key.

Lock Kit, Door, Ignition And Trunk
67-69 C7AZ-6222050-MK

GLOVEBOX LOCK & COMPONENTS

GLOVEBOX LATCH



All new tooling was created to produce our glovebox latches. These are very nice. Also available as a locking version with keys.

Glovebox Latch
64-65 std., curved glove box door C5ZZ-6506072-A
65-66 dlx., flat glove box door C5ZZ-6506072-B
67-68 std. C6DZ-6506072-A
69-70 std. C9ZZ-6506072-A

LOCKABLE GLOVEBOX LATCH



A great optional accessory from Scott Drake. All new tooling was created to produce our glovebox latches. Includes 2 matching keys.

Glovebox Latch, Lockable
64-65 std., curved door C5ZZ-6506072-AL
65-66 dlx., flat door C5ZZ-6506072-BL
67-68 std. C6DZ-6506072-AL
69-70 std. C9ZZ-6506072-AL

GLOVEBOX STRIKER KIT



Exact reproduction of the original. Hardware included. Also available in bright Chrome Finish.

Glovebox Striker Kit
64-66 Zinc C5ZZ-6506064-A
64-66 Chrome C5ZZ-6506064-C

GLOVEBOX AND TRUNK LOCK KIT



New from Scott Drake. All new tooling was created to produce our glovebox latches. This kit allows the use of one key for the glovebox and trunk lock.
Lock Kit, Glovebox And Trunk
67-68 C6DZ-6506072-K
69-70 C9ZZ-6506072-K

HOOD LOCKS & PINS

HOOD PIN KIT

Classic hood pins and all hardware needed to install them.

Hood Pin Kit



64-73: w/ cables, all stainless
C5ZZ-16892-SSK



64-73: w/out cables
S1MS-16892-A



64-73: w/ cables
S1MS-16892-DLX



64-73: Billet, w/ cables
S1MS-16892-K



67: w/ cables, Shelby
S7MS-16892-A



69: Mach 1
C90Z-16700-A

HOOD TWIST LOCK

Beautiful chrome handle that is turned to lock the hood down.



Hood Twist Lock



68: Shelby & California Special
C8ZZ-16C896-A



69-70: Shelby®
S9MS-16C892-A



70: Chrome
D0ZZ-16C896-A



71-73: Ram Air
D1ZZ-16896

HOOD LOCK BRACKET



California Special Hood Lock Bracket. Stamped steel construction. Sold individually.

Hood Lock Bracket
68 California SpecialC8Z-16934-A

HOOD TWIST LOCK CATCH



This is the catch for the twist lock.

Hood Twist Lock Catch
70 D0ZZ-16894

HOOD TWIST LOCK RETAINER



Retainer that mounts to the core support to accept the hood lock.

Hood Twist Lock Retainer
70 D0ZZ-16712

KEYS

KEY

Little touches make a big difference. These blanks have the correct Ford script or running horse. Key



64-66: Pony, ignition & door
C5Z-6522053-B



64-66: Pony, trunk & glovebox
C5Z-6543562-B



67-73: std., ignition & door
C7AZ-6222053-A



67-73: Pony, ignition & door
C7AZ-6222053-H



67-73: std., trunk & glovebox
C7AZ-6243562-A



67-73: Pony, trunk & glovebox
C7AZ-6243562-H

TRUNK LOCKS

ELECTRIC TRUNK RELEASE KIT



We combined the classic look of the original remote trunk release with a chrome release lever and a

strong electric solenoid driven latch with a modern micro switch release. Now, with a light finger pull the trunk lid opens. No cables to stretch or corrode. Simple 30 minute installation with no modifications to the car. All mounting hardware and connectors are included. Fits Coupe, Fastback and Convertible.

Electric Trunk Release Kit

64-66C5AZ-6243200-EL
67-70C7AZ-6243200-EL

WIRELESS TRUNK RELEASE



This is an upgrade to our Electronic Trunk Release. Allows trunk to be opened with just the push of a button on

two wireless remotes that are included.

Trunk release, wireless

64-70 C5Z-6243200-WR

TRUNK LATCH

Heavy duty steel stamped construction with a bright zinc plated finish
Trunk Latch



64-66
C20Z-6243200-B



67-73
C5AZ-6243200-A

TRUNK LATCH STRIKER



Exact detail made from heavy gauge steel. Available in silver zinc or bright chrome.

Trunk Latch Striker

64-66 C40B-6243252
64-66 ChromeC40B-6243252-C

TRUNK LOCK CYLINDER



Our trunk cylinders are an exact copy, but the keys are a replacement type. Also available with Pony keys.

Trunk Lock Cylinder

64-66 std. keysC50Z-6243505-B
64-66 Pony keysC50Z-6243505-P
67-73 std. keysC7AZ-6243505-B

TRUNK LOCK CYLINDER SLEEVE



Pressure die cast with show car chrome. Comes with nut, washer and gasket.

Trunk Lock Cylinder Sleeve

64-66 C5Z-6543603-B

TRUNK LOCK HOUSING SPACER



Stamped steel housing spacer that attaches behind chrome trunk housing. Zinc plated

Trunk Lock Housing Spacer

64-66 C5Z-6543565-A

TRUNK LOCK STEM EXTENSION



Exact reproductions of the originals for a perfect fit and the right look.

Trunk Lock Stem Extension

64-66 Concours C5Z-6543283-A
67-68 Concours C7Z-6543283-AR
67-73 Economy, must cut to fit ... C7Z-6543283-A

LITERATURE

ASSEMBLY MANUALS

BODY ASSEMBLY MANUAL



This manual shows how to attach all body components and gives you the actual Ford part numbers for the hardware needed.

Manual, Body Assembly

64	AM-1
65	AM-6
66	AM-11
67	AM-16
68	AM-21
69	AM-26
70	AM-31
71-72	AM-41
73	AM-46

CHASSIS ASSEMBLY MANUAL



This book shows every aspect of the steering, suspension, exhaust and all other chassis

components as well as all mounting hardware.

Manual, Chassis Assembly

64-65	AM-5
67	AM-20
68	AM-25
69	AM-30
70	AM-35
73	AM-50

ELECTRICAL ASSEMBLY MANUAL



This Electrical Assembly Manual features detailed drawings and schematics of the electrical system. Very easy to read.

Manual, Electrical Assembly

64	AM-3
65	AM-8
66	AM-13
67	AM-18
68	AM-23
69	AM-28
70	AM-33
71-72	AM-43

INTERIOR ASSEMBLY MANUAL



This manual is perfect for showing the proper placement of each interior component. From headliner to

carpet and even the Ford part numbers for the attaching hardware, this book has it all.

Manual, Interior Assembly

64	AM-2
65	AM-7
66	AM-12
67	AM-17
68	AM-22
70	AM-32
71-72	AM-37

WELD-SEALANT MANUAL



Anyone doing a total restoration and wanting to do it correctly needs this manual. While showing proper drawings of every

sheet metal part, it also illustrates where Ford put sealant and anti-rattle material as well as the proper Ford part numbers for them.

Manual, Weld-Sealant

64	AM-9
67	AM-19
68	AM-24
70	AM-34
71-72	AM-39

CONVERTIBLE TOP REPAIR MANUAL



The convertible top is the most complicated part of any car. This manual features complete top adjustments, servicing, electrical and trouble-shooting. 15 pages soft bond

Manual, Convertible Top Repair

64-66	MP-14
-------	-------	-------

ENGINE COMPONENT ASSEMBLY MANUAL



Manual, Engine Component Assembly

64	AM-154
65	AM-155
66	AM-156
67	AM-157
69	AM-159

EXPLODED VIEW ILLUSTRATION MANUAL



Shows all Ford illustrations, easy to read, great for seeing how assemblies fit together. Also lists basic part numbers.

Manual, Exploded View Illustration

64-65	MP-309
66	MP-347
67-68	MP-313
69-70	MP-348

SHOP MANUAL



A must for anyone planning to work on their own car. This is an easy sell when your customers start looking through the wealth of information contained in these books. All books

contain detailed instructions on disassembly and assembly of all major components.

Manual, Shop

64	Supplement	MP-27
64	SM-64	
65	SM-65	
66	SM-66	
67	SM-67	
68	SM-68	
69	SM-69	
70	SM-70	
71	SM-71	
72	SM-72	
73	SM-73	
73	Emissions	SM-73-E

TILT-A-WAY COLUMN REPAIR AND DIAGNOSTIC MANUAL



Manual, Tilt -a- Way Column Repair And Diagnostic

67-69	Tilt-A-Way	MP-310
-------	------------	-------	--------

VACUUM SCHEMATIC MANUAL



Saves time and frustration! Shows schematic and diagrams that reveal the location and function of the many vacuum systems on Mustangs and Shelys.

Manual, Vacuum Schematic

67	Mustang & Shelby	MP-150
68	Mustang & Shelby	MP-151
69	Mustang & Cougar	MP-152
70	Mustang & Cougar	MP-153
71	Mustang & Cougar	MP-154
72	Mustang & Cougar	MP-155
73	Mustang & Cougar	MP-156

WE PROUDLY FEATURE AUTHENTIC MUSTANG REPRODUCTIONS FROM SCOTT DRAKE ENTERPRISES!



WIRING DIAGRAM MANUAL

Covers a multitude of electrical pictorial diagrams, color codes are listed, plus easy to follow schematics.

Wiring Diagram Manual

64	MP-312
65	MP-1
66	MP-2
67	MP-3
68	MP-4
69	MP-5
70	MP-6
71	MP-7
72	MP-8
73	MP-9

LARGE FORMAT**WIRING DIAGRAM MANUAL**

Covers a multitude of electrical pictorial diagrams, color codes are listed, plus easy to follow schematics. Our large format features larger diagrams that are easier to read.

Wiring Diagram Manual, Large Format

64	MP-311-P
65	MP-1-P
66	MP-2-P
67	MP-3-P
68	MP-4-P
69	MP-5-P
70	MP-6-P
71	MP-7-P
72	MP-8-P
73	MP-9-P

GENERAL LIBRARY**ACCESSORY PRICE GUIDE**

These neat little booklets show original cost of options and accessories. Used by dealers to figure out cost for special order cars.

Accessory Price Guide

65	DF-55
66	DF-56
67	Shelby	DF-257
67	DF-97
68	Shelby	DF-258
68	DF-98
69	DF-99
69-70	Shelby	DF-259
70	DF-100
71	DF-101
72	DF-102
73	DF-103

BOSS 302 CHASSIS MODIFICATIONS

Reprints of original Ford brochures. Great for beefing up the Boss 302. Approximately 30 pages each. Soft bound.

Boss 302 Chassis Modifications

69-70	MP-11
-------	-------	-------

BOSS 302 ENGINE MODIFICATIONS

Reprints of original Ford brochures. Great for beefing up the Boss 302. Approximately 30 pages each. Soft bound.

Boss 302 Engine Modifications

69-70	MP-10
-------	-------	-------

BOSS AND COBRA JET MUSTANGS

This 128 page paperback book covers the design, development, and racing history of each Boss and Cobra Jet line with in-depth text and over 125 modern and archival photographs.

Boss And Cobra Jet Mustangs

68-71	Boss & Cobra Jet	122799AP
-------	------------------	-------	----------

BOSSSES: 302, 351, 429

Spans from 1969 - 1971. Covers specs, features, construction and much more. Copies from original sales literature. 30 pages. Soft bound.

Bosses: 302, 351, 429

69-71	MP-25
-------	-------	-------

1964-93 CATALOG OF MUSTANG ID NUMBERS

325 page paperback book on how to decode VIN plates, body tags, engine numbers, paint and trim codes. Also includes full color illustration of paint colors and Interior fabrics.

Catalog Of Mustang ID Numbers, 1964-93

64-93	120039AP
-------	-------	----------

THE COMPLETE BOOK OF FORD O.H.O. NEWSLETTERS

This 40 page paperback collection of "Off Highway Operation" newsletters published by Ford.

Complete Book Of Ford O.H.O. Newsletters, The

64-73	MP-120
-------	-------	--------

FORD : 100 YEARS

This soft cover 224 page book is full of B&W photos. Another great source of information from Peter C. Sessler.

Ford : 100 Years

64-73	Centennial *	135942AP
-------	--------------	-------	----------

FORD HIGH PERFORMANCE PARTS IDENTIFIER

Now it's easy to authenticate any high performance engine. Describes casting, numbers on engines, engine components, transmission, and differential. 88 pages. Also features information

on building and restoring a 289 HiPo. By Robert Winkelman.

Ford High Performance Parts Identifier

63-73	L-68
-------	-------	------

FORD PARTS INTERCHANGE MANUAL

This book will pay for itself your first swapmeet or junk yard visit. Excellent guide on what Ford products cross over from car to car and year to year.

Ford Parts Interchange Manual

64-73	122151AP
-------	-------	----------

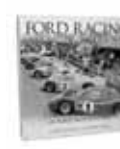
FORD RACING CENTURY

A beautiful 10X10 hardcover book by Larry Edsall & Mike Teske. Over 300 pages filled with hundreds of color and black & white photos. From the early days of racing all the

way to NASCAR racing today. A "must have" for your library.

Ford Racing Century

64-73	136328AP
-------	-------	----------

FORDS OF THE SIXTIES

Another one of California Bill's automotive handbooks by Michael Parris. Over 175 pages filled with great shots

of the Classic Mustang and Fords from the 60's. There are even some cars that we've never seen before. Foreword by Edsel B. Ford. A Great edition to the auto enthusiast's library. Soft cover.

Fords Of The Sixties

60-69	136338AE
-------	-------	----------

HIGH PERFORMANCE DATA HANDBOOK



This 26 page paperback book designed to detail what specific competitive makes are in direct competition

with each of Fords performance offerings.

High Performance Data Handbook

70 MP-329

HIGH PERFORMANCE PARTS



This 38 page paperback booklet covering big block modification for power and performance. Also has a listing of Autolite-Ford Hi-Per parts available through

Ford and Lincoln-Mercury dealers.

High Performance Parts

61-80 MP-42

HOW TO PAINT YOUR MUSTANG



This is a step by step procedure manual designed for first time painters. Discusses cleaning, disassembly, body preparation, painting

techniques, equipment, reassembly, paint codes and stripes.

How To Paint Your Mustang

64-73 L-70

351M, 400, 429 AND 460 HOW TO REBUILD YOUR FORD 8 CYLINDER



This book covers all the necessary steps in rebuilding a long block.

How To Rebuild Your Ford 8 Cylinder, 351M, 400, 429 and 460

64-73 HP-36

HOW TO REBUILD YOUR FORD BIG BLOCK



This book covers all the necessary steps in rebuilding a long block.

How To Rebuild Your Ford Big Block

67-73 HP-708

HOW TO REBUILD YOUR SMALL BLOCK FORD ENGINE



This book covers all the necessary steps in rebuilding a long block.

How To Rebuild Your Small Block Ford Engine

64-73 HP-89

HOW TO RESTORE YOUR MUSTANG



Good fundamental ground up guide, showing step by step procedures for 1965 - 1968 Mustangs. This has been the best seller for several years.

Easy to read, shows numerous

photographs. Also contains color charts for exterior, upholstery, convertible tops, vinyl tops, and carpet.

How To Restore Your Mustang

65-68 L-61

MUSTANG 1964-1968 A COLOR HISTORY



This 128 page soft bound book is full of great full paged detailed photos of the early Mustangs. by Tom Corcoran.

Mustang 1964-1968 A Color History

64-68 119047AP

THE MUSTANG & COUGAR TAGBOOK



This book has everything you need to know for deciphering the codes on all the mysterious tags found on your Mustang or Cougar (1965-73 Models).

Mustang and Cougar Tagbook, The

65-73 MB-102

MUSTANG COLLECTIBLES



This hardbound, 127 page, full color book is packed with hundreds of Mustang collectibles. Over 200 photographs. Includes price guide.

Mustang Collectibles

64-73 135130AP

MUSTANG FACT BOOK



Originally printed to provide Fords sales force with adequate product knowledge. Today's usage is numerous. Contains

information on production, performance, economy, competition, accessories and prices.

Mustang Fact Book

64 MP-291

65 MP-292

66 MP-293

67 MP-294

68 MP-295

69 MP-296

69 MP-297

71 MP-298

72 MP-299

73 MP-300

VOLUME 1 MUSTANG HOW TO



This is Vol. 1 of a two part series. Contains 25 "How To" instruction articles. You'll find answers and instructions to the 25 most asked Mustang questions. "How To" improve handling, repair

leaking cowl panels, remedy sloppy shifters, replace a convertible top, and "How To" replace a headliner, plus much, much more.

Mustang How To, Volume 1

64-73 L-72

VOLUME 2 MUSTANG HOW TO



This is Vol. 2 of the ever popular "How To" instruction articles.

Talks about the following: rebuild a toploader, install a Rally Pac, add front disc brakes, replace vinyl tops, replace

carpet, plus much, much more.

Mustang How To, Volume 2

64-73 L-74

MUSTANG BY THE NUMBERS MUSTANG PRODUCTION BOOK



Mustangs by the numbers. This new book features production facts on the 1967 - 1973

Mustang. The author obtained the entire production database from the Ford Motor Company

under license. This book contains over 12,000 statistics. Did you know only 1 1967 fastback was painted Diamond Green?

Mustang Production Book, Mustang By The Numbers

67-73 MB-101

WE PROUDLY FEATURE AUTHENTIC MUSTANG REPRODUCTIONS FROM SCOTT DRAKE ENTERPRISES!



MUSTANG RECOGNITION GUIDE

A full 226-pages of the Mustang history year by year. Hundreds of color photographs. A detailed study of interior and exterior. Also includes Shelby and California special.

Mustang Recognition Guide

64-73 L-69

BUYERS GUIDE 1964-2000**MUSTANG RED BOOK**

Great model to model guide from 1964 1/2 - 2000. If you're thinking about buying a Mustang, this book is for you. Includes original vehicle and optional equipment prices,

serial numbers, production figures, interior and exterior colors and much more. 192 pages and 45 photos, soft bound.

Mustang Red Book, Buyers Guide 1964-2000

64-00 115172AP

MUSTANG RESTORATION**HANDBOOK**

Great overall coverage of entire vehicle. Features articles on history, how to buy used, disassembly, suspension, steering, brakes, engine, body, paint, interior, convertible top plus much more.

176 pages, 500 illustrations. Soft bound.

Mustang Restoration Handbook

65-70 HP-029

MUSTANG RESTORATION TIPS & TECHNIQUES

Compiled from Hot Rod Magazine. Features lots of how to's, sheet metal repairs, doors, interiors, flares, engine blueprinting, transmissions, suspension swaps, buying used,

rust & dent repairs plus painting. 163 pages, 100+ illustrations. Soft bound.

Mustang Restoration Tips And Techniques

64-73 111084AE

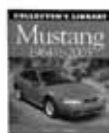
MUSTANG: 1964-2003

This soft cover 224 page book is full of B&W photos. Another great source of information from Peter C. Sessler.

Mustang: 1964-2003

64-03 135137AP

MUSTANG: FORTY YEARS

This is the big one. A true coffee table book. This book as more than 380 pages and is hard covered. Fantastic full color photographs are beautifully printed on each

page. Randy Leffingwell & David Newhardt have done a great job.

Mustang: Forty Years

64-94 136274AP

MUSTANG: THE ORIGINAL MUSCLE**CAR**

This 191 page soft cover book is full of color photos of Mustangs from the early years through the late 1990's. Follow the wonderfully written history starting long

before the Mustang was introduced. By Randy Leffingwell.

Mustang: The Original Muscle Car

64-94 134970AP

OFF HIGHWAY PARTS BOOK

This 124 page paperback book written to assist in the selection and modification of Ford engines and parts.

Off Highway Parts Book

64-73 MP-13

PAINT AND BODY : HOW TO BOOK

For those of you who want to learn paint & body work but need step-by-step help. This book is for you. Covers the basics, disassembly, welding, shaping sheet metal,

sectioning, straightening, paints, equipment and techniques. 144 pages, 460+ illustrations. Soft bound.

Paint And Body : How To Book

64-73 HP-204

POCKET SIZE DATA PLATE**DECODER**

It's easy to use, and pocket size. Perfect for checking patent data plates and warranty number plate. Covers 1965 - 1973.

Pocket Size Data Plate Decoder

65-73 L-64

SERVICE SPECIFICATIONS

These manuals show all the specs for every car made by Ford, Lincoln and Mercury for the specified year.

Service Specifications

67 * 7202-67

68 * 7202-68

SHELBY AMERICA ACCESSORIES**MANUAL**

20 page paperback manual covering a few Shelby accessory installation procedures.

Shelby America Accessories Manual

64-73 \$ MP-335

SHELBY COBRA

Over 300 photos. Features road tests, specs and performance data. 180 pages. Soft bound. By R.M. Clarke.

Shelby Cobra

64-69 \$ 115173AE

SHELBY SALESMAN DATA MANUAL

Exact copy of original Ford brochure. Features specs and selling features.

Shelby Salesman Data Manual

68 \$ MP-83

SHELBY UNIQUE PARTS MANUAL

Lists all parts unique to Shelys. Shows many exploded views.

Shelby Unique Parts Manual

66 \$ MP-333

68 \$ MP-58

69-70 \$ MP-57

OWNERS MANUALS

OWNERS MANUAL



Exact reprint of the original manual right down to the paper texture.

Owners Manual

64	OM-64
65	OM-65
65	Shelby	OM-65-S
66	OM-66
66	w/ hi-po Engine	OM-66-HP
66	Shelby	OM-66-S
67	OM-67
67	Shelby	OM-67-S
68	OM-68
68	Shelby	OM-68-S
69	OM-69
69	Boss 429	OM-69-B
69	Shelby	OM-69-S
70	OM-70
70	Boss 429	OM-70-B
70	Shelby	OM-70-S
71	Ford car	OM-71
71	Mustang supplement	OM-71-SS
71	Boss 351	OM-71-B
72	OM-72
73	OM-73

OWNERS MANUAL WALLET

Protection for your owners manual. Blue vinyl.



Owners Manual Wallet

64-73	*	ACC-OMW
-------	---	-------	---------

MIRRORS

INSIDE REAR VIEW MIRRORS

INSIDE REAR VIEW MIRROR & ARM KIT



Save money with this quite attractive new kit. Includes standard mirror and our pressure die cast arm.

Inside Rear View Mirror And Arm Kit

64-66	KIT-MIR-1
-------	-------	-----------

INSIDE REAR VIEW MIRROR BRACKET



Special cast-metal bracket glues to windshield. Plain finish. Exact detail. Fits the original arm.

Inside Rear View Mirror Bracket

68-69	C8AZ-17698-A
70-79	C9AZ-17698-A

INSIDE REAR VIEW MIRROR ARM

Pressure die cast, with quality chrome. Replaces one of the most visible interior parts on a Mustang.

Inside Rear View Mirror Arm



64-66	C5ZZ-17690-D
-------	--------------



67	C7ZZ-17690-A
----	--------------



68-69	C2SZ-17690-F
-------	--------------

INSIDE REAR VIEW MIRROR

Exact copies, with all the right details. Improved mirror with superior quality crimping of frame to glass. Chrome plated or black back just like originals.

Inside Rear View Mirror



64-65: Day/Night push button	C5ZZ-17700-B
------------------------------	--------------



64-66: Show quality	C5ZZ-17700-A
---------------------	--------------



65-66: Day/Night turn button	C6ZZ-17700-A
------------------------------	--------------



67: Day/Night	C7ZZ-17700-A
---------------	--------------



68-69: Day/Night, concours	C7AZ-17700-G
----------------------------	--------------



68-70: Day/Night, aftermarket	C8AZ-17700-A
-------------------------------	--------------

INSIDE REAR VIEW MIRROR ADHESIVE



Remounts rearview mirror bracket to windshield permanently. Mounting strength is 300 psi. Unaffected by

hot and cold temperature variation. Supplied in 0.04 ounce tube.

Inside Rear View Mirror Adhesive

64-73	PRO-61067
-------	-------	-----------

OUTSIDE MIRRORS

64-66 OUTSIDE MIRROR



These outside mirrors feature flawless chrome and a perfect fit. Mirrors fit both left and right hand side, but we recommend our mirrors with convex glass for the

right hand side because they have a greater field of vision. All mirrors come with base pad and mounting screws.

Outside Mirror, 64-66

64-66	Chrome, economy	C3RZ-17696-A
64-66	Chrome, show-quality	...	C3RZ-17696-R
64-66	Chrome, convex, RH	C3RZ-17696-C

64-66, BLACK CHROME OUTSIDE MIRROR



These outside mirrors feature our much anticipated Black Chrome finish! Match these with our black chrome door handles for a custom look that is sure to turn heads.

Mirrors fit both left and right hand side, but we recommend our mirrors with convex glass for the right hand side because they have a greater field of vision. All mirrors come with base pad and mounting screws.

Outside Mirror, 64-66, Black Chrome

64-66	C3RZ-17696-RB	
64-66	Convex, RH	C3RZ-17696-CB

64-66, SATIN CHROME OUTSIDE MIRROR



These outside mirrors feature our smooth, satin chrome finish! Our satin chrome finish is a great compliment to billet aluminum. Match these with our satin chrome

door handles for a custom look. Mirrors fit both left and right hand side, but we recommend our mirrors with convex glass for the right hand side because they have a greater field of vision. All mirrors come with base pad and mounting screws.

Outside Mirror, 64-66, Satin Chrome

64-66	C3RZ-17696-RS	
64-66	Convex, RH	C3RZ-17696-CS

WE PROUDLY FEATURE AUTHENTIC MUSTANG REPRODUCTIONS FROM SCOTT DRAKE ENTERPRISES!



67-73 OUTSIDE MIRROR



These outside mirrors feature flawless chrome and a perfect fit. Mirrors fit both left and right hand side, but we recommend

our mirrors with convex glass for the right hand side because they have a greater field of vision. All mirrors come with base pad and mounting screws.

Outside Mirror, 67-73

- 67-73 Chrome, long base, concours ..C7AZ-17696-A
- 67-73 Chrome, convex, long base, RH, concours C7AZ-17696-C
- 70-73 Chrome, short base D1ZZ-17696-A

67-73, BLACK CHROME OUTSIDE MIRROR



These outside mirrors feature our much anticipated Black Chrome finish! Match these with our black chrome door handles

for a custom look that is sure to turn heads. Mirrors fit both left and right hand side, but we recommend our mirrors with convex glass for the right hand side because they have a greater field of vision. All mirrors come with base pad and mounting screws.

Outside Mirror, 67-73, Black Chrome

- 67-73 C7AZ-17696-AB
- 67-73 Convex, RHC7AZ-17696-CB

67-73, SATIN CHROME OUTSIDE MIRROR



These outside mirrors feature our smooth, satin chrome finish! Our satin chrome finish is a great compliment to billet aluminum.

Match these with our satin chrome door handles for a custom look. Mirrors fit both left and right hand side, but we recommend our mirrors with convex glass for the right hand side because they have a greater field of vision. All mirrors come with base pad and mounting screws.

Outside Mirror, 67-73, Satin Chrome

- 67-73C7AZ-17696-AS
- 67-73 Convex, RHC7AZ-17696-CS

OUTSIDE MIRROR BASE PAD



Black molded plastic which has a bead around perimeter just like the original.

Outside Mirror Base Pad

- 64-66 C3RZ-17724-A
- 64-66 RemoteC5ZZ-17724-A
- 65-66 Shelby bullet S1MS-17724
- 67-68C7ZZ-17724-A
- 69-70 RacingC9ZZ-17724-A

OUTSIDE MIRROR MOUNTING KIT



These simple kits are an easy solution to oversized screw holes (or missing nuts on 67-73 Mustangs).

Outside Mirror Mounting Kit

- 64-66 std.C3RZ-17696-MK
- 64-66 RemoteC5ZZ-17696-MK
- 67-73 AllC7AZ-17696-MK

RACING MIRROR



Show car quality, made in America. Exact copy of Rotunda mirror offered years ago. Includes pads, mounting hardware and positioning templates.

Racing Mirror

- 64-68 Bullet, show-quality C5RZ-17696-A
- 64-68 Bullet, importC5RZ-17696-AS
- 64-68 Bullet, show quality, convex . C5RZ-17696-B
- 64-68 Bullet, long base C5RZ-17696-AL
- 64-68 Bullet, long base, convex .. C5RZ-17696-ALC
- 69 Early 69C9ZZ-17696-C
- 69-70 Late 69, LHC9ZZ-17696-L
- 69-70 RHC9ZZ-17696-R
- 71-73 Remote, LHD1ZZ-17696-L
- 71-73 RH D1ZZ-17696-R

REMOTE CONTROL MIRROR



Super quality mirror by Scott Drake. These are superior to anything on the market. Features the highest quality chrome finish.

Pad and mounting hardware included. Made in the USA with pride. Show quality. Also available with convex glass for improved view.

Remote Control Mirror

- 64-66 LH, economy, imported ...C5ZZ-17696-A
- 64-66 LH, concoursC5ZZ-17696-BR
- 64-66 RH, w/out logoC5ZZ-17696-R
- 64-66 RH, Rotunda logo, "dummy remote" C5ZZ-17696-RR
- 64-66 RH, convex, w/ logo C5ZZ-17696-CR
- 64-66 LH, Rotunda logo C5ZZ-17696-LR
- 67-68 LH, economy, imported ...C7AZ-17696-E
- 67 LH, concoursC7AZ-17696-ER
- 67 LH, convex C7AZ-17696-ERC
- 67-68 RH, concours C8AZ-17696-AR
- 67-68 RH, convexC8AZ-17696-CR
- 68 LH, concoursC8AZ-17696-ER

REMOTE MIRROR BEZEL



A nice reproduction of the inner door Remote Mirror Bezel.

Remote Mirror Bezel

- 69C8SZ-17B733-B

SPORT MIRROR BEZEL NUT

A nice reproduction.



Sport Mirror Bezel Nut

- 69 C6GY-17B719-A
- 70-71C9TZ-17B732-A

MOLDING

EXTERIOR MOLDINGS

BODY MOLDING KIT



Featured on all deluxe decor group. Ten piece kit. Hardware not included.

Body Molding Kit

71-73 10 piece kitD1ZZ-6320938KIT

DRIP RAIL MOLDING



Stainless steel stamped moldings that attach to drip rail or roof rail. Economy moldings

to replace damaged or missing originals.

Drip Rail Molding

64-68 CP C5ZZ-6551726/7A
 65-66 FB C5ZZ-6351726/7A
 67-68 FB C7ZZ-6351726/7A
 69-70 FB C9ZZ-6351726/7A
 69-70 w/out vinyl top C9ZZ-6551726/7A

DRIP RAIL MOLDING JOINT COVER



Pressure die cast like original and chrome plated. Fastback only.

Drip Rail Molding Joint Cover

69-70 C9ZZ-6351828/9A

FASTBACK DOOR GLASS MOLDING



Beautiful reproduction. Made from the original Ford Tooling. Made from rust proof 304 stainless steel. Attaches to back of

door glass. Rubber seal sold separately.

Fastback Door Glass Molding

69-70 FB, RH D0ZZ-6322220-A
 69-70 FB, LH D0ZZ-6322221-A

FRONT FENDER EXTENSION MOLDING



Nice reproduction, die-cast zinc construction.

Front Fender Extension Molding

71-72 Chrome D1ZZ-16160/1
 73 Paint to match D3ZZ-16160/1

HOOD MOLDING



For the front of the hood, to trim the edge. Formed from aluminum, as the originals were. Mounting hardware is included.

Hood Molding

64-66 C5ZZ-16856-A
 67-68 C7ZZ-16856-A
 69 C9ZZ-16856-A
 70 D0ZZ-16856-AR
 71-72 Chrome D1ZZ-16856-A
 71-73 Ready to paint D1ZZ-16856-B

GRILLE MOLDING AND TRIM



Fits on outside of grill opening. 64-70 molding includes mounting hardware. For all 71-73 molding, mounting clips are sold separately.

Grille Molding And Trim

64-66 RH, wide C5ZZ-8242-AR
 64-66 LH, wide C5ZZ-8243-AR
 67-68 RH, wide C7ZZ-8190-AR
 67-68 LH, wide C7ZZ-8191-AR
 67-68 RH, narrow C7ZZ-8242-AR
 67-68 LH, narrow C7ZZ-8243-AR
 69 Lower grille panel C9ZZ-8221-A
 69 RH, wide C9ZZ-8242-AR
 69 LH, wide C9ZZ-8243-AR
 69 RH, narrow C9ZZ-8242-BR
 69 LH, narrow C9ZZ-8243-BR
 69 Center, narrow C9ZZ-8419-AR
 70 Center, wide D0ZZ-8221-A
 71-72 Upper or lower D1ZZ-8419-B
 71-72 RH D1ZZ-8419-C
 71-72 LH D1ZZ-8419-E
 73 RH D3ZZ-8242-A
 73 LH D3ZZ-8243-A
 73 Upper or lower D3ZZ-8419-C

GRILLE MOLDING CENTER JOINT COVER



Chrome is better than original, recessed area is painted Argent Silver. All necessary fasteners are included.

Grille Molding Center Joint Cover

66 Center C6ZZ-8221-A
 67-68 Center Joint Cover C7ZZ-8221-AR

MOLDING HARDWARE



We offer these complete hardware kits for your customer's convenience. Kits include high strength

backing plates and all necessary screws, clips, or rivets.

Molding Hardware

64-66 RH or LH C5ZZ-6510182-K
 67-68 LH C7ZZ-6510182-KL
 67-68 RH C7ZZ-6510182-KR

MOLDING RETAINER CLIP

Exact OEM replacements. Plated to stop corrosion.

Molding Retainer Clip



65
 C5ZZ-65423A26-A



66-68
 C5ZZ-65423A26-B



67-68: Top molding only
 C7ZZ-65423A26-A



69-70: Rear window, CP
 C9ZZ-65423A26-A

QUARTER PANEL ORNAMENT

Fine reproductions to ensure you of the finest quality, fit, and appearance.

Quarter Panel Ornament



64-65
 C5ZZ-65290A76/7



66: Concours, new tooling
 C6ZZ-65290A76/7



67: Set of 4
 C7ZZ-65291A52/3



68: Chrome trim
 C8ZZ-65290A767A



68: Base, paint to match
 C8ZZ-65290C82/3



69
 C9ZZ-65290D14/5

WE PROUDLY FEATURE AUTHENTIC MUSTANG REPRODUCTIONS FROM SCOTT DRAKE ENTERPRISES!



QUARTER WINDOW MOLDING



Pressure die cast like original and chrome plated.

Quarter Window Molding

69-70 FB C9ZZ-6329796/7A

QUARTER WINDOW TRIM



Pressure die cast like original and chrome plated.

Quarter Window Trim

69-70 CP C9ZZ-6529796/7

REAR WINDOW MOLDING KIT

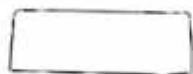

This is just the kit to replace that dented, scratched or missing rear window trim on your Mustang.

Rear Window Molding Kit

64-66 CP, 6 piece kit C5ZZ-6542404
 65-66 FB, 4 piece kit C5ZZ-6342404
 67-68 FB, 6 piece kit C7ZZ-6342404
 67-68 CP, 4 piece kit C7ZZ-6542404
 69-70 FB, 4 piece kit C9ZZ-6342404
 71-73 FB D1ZZ-6342404

ROCKER MOLDING



Aluminum stampings, highly polished with a great fit. 64-69 moldings come with attaching hardware.

Rocker Molding

64-66 C5ZZ-6510176/7A
 67-68 C7ZZ-6510176/7
 69 C9ZZ-6510176/7
 70 Mach 1, concours D0ZZ-6320938KIT
 70 Mach 1, economy D0ZZ-6320938-KR
 71-73 10 piece kit D1ZZ-6320938KIT
 71-73 D1ZZ-6510176/7

TAIL LIGHT PANEL FASTENERS



A set of 12 gold cadmium plated, dome shaped nuts used to attach the honeycomb panel that mounts between the tail lamps on 1970 through 1973 Mustangs

1970 through 1973 Mustangs

Tail Light Panel Fasteners

70-73 382146-SMK

TAIL LIGHT PANEL MOLDING

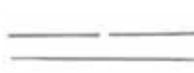

Polished aluminum moldings which fit on the honey comb optional panel. Please

see sheetmetal section for honeycomb panel. Will fit on all body styles for 1970 but is original for Mach 1 only.

Tail Light Panel Molding

70 3 piece kit D0ZZ-63423A82/4
 71-73 2 piece kit D1ZZ-63423A82/4

TAIL LIGHT PANEL MOLDING CLIPS



These 12 special retaining clips are used to mount the Tail Lamp Panel Moldings on all 70-73 Mach 1's. Retaining

nuts are sold separately (# 382146-SMK).

Tail Light Panel Molding Clips

70-73 D0GY-65291B80-A

TRUNK MOLDING

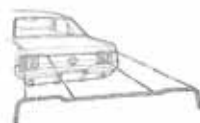

Brightly polished aluminum moldings that are easy to install. All moldings come with attaching hardware.

Trunk Molding

67-68 FB, RH quarter extension trim C7ZZ-6329078-A
 67-68 FB, LH quarter extension trim C7ZZ-6329079-A
 67-68 FB, trunk trim C7ZZ-6342512-A
 67-68 CP/CV, RH quarter extension trim ... C7ZZ-6529078-A
 67-68 CP/CV, LH quarter extension trim C7ZZ-6529079-A
 67-68 CP/CV, trunk trim C7ZZ-6542512-A
 69-70 CP/CV, RH quarter extension trim ... C9ZZ-6529078-A
 69-70 CP/CV, LH quarter extension trim C9ZZ-6529079-A
 69-70 CP/CV, trunk trim C9ZZ-6542512-A

VINYL TOP MOLDING



Pressure die cast construction and chrome plated.

Vinyl Top Molding

65-66 C5ZZ-65423A18/9
 67-68 C7ZZ-65423A18/9

WHEEL OPENING MOLDING KIT



Although not an original option, this kit is very popular. Our wheel opening molding are roll-formed aluminum,

just like the 67-73 versions. Mounting screws included. All 4 moldings included in kit.

Wheel Opening Molding Kit

64-66 C5ZZ-16038-KIT

WHEEL OPENING MOLDING



Our wheel opening molding are roll-formed aluminum, just like the originals. Mounting screws are included with these moldings.

Wheel Opening Molding

67-68 Front, RH C7ZZ-16038-B
 67-68 Front, LH C7ZZ-16039-B
 67-68 Rear, RH C7ZZ-6529164-A
 67-68 Rear, LH C7ZZ-6529165-A
 69 Front, RH C9ZZ-16038-B
 69 Front, LH C9ZZ-16039-B
 69 FB, rear, RH C9ZZ-6329164-A
 69 FB, rear, LH C9ZZ-6329165-A
 69 CP/CV, rear, RH C9ZZ-6529164-A
 69 CP/CV, rear, LH C9ZZ-6529165-A
 70 Front, RH D0ZZ-16038-B
 70 Front, LH D0ZZ-16039-B
 70 FB, rear, RH D0ZZ-6329164-A
 70 FB, rear, LH D0ZZ-6329165-A
 70 CP/CV, rear, RH D0ZZ-6529164-A
 70 CP/CV, rear, LH D0ZZ-6529165-A
 71-73 Front, RH D1ZZ-16038-AR
 71-73 Front, LH D1ZZ-16039-AR
 71-73 Rear, RH D1ZZ-6529164-AR
 71-73 Rear, LH D1ZZ-6529165-AR

WINDSHIELD MOLDING

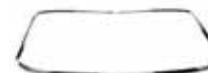

These formed stainless steel moldings are a good reproduction at an economical price.

They are polished like the originals.

Windshield Molding

64-68 Side, RH C5ZZ-6503136-BR
 64-68 Side, LH C5ZZ-6503137-BR
 64-68 Top, RH C5ZZ-6503144-BR
 64-68 Top, LH C5ZZ-6503145-BR
 64-68 Lower C5ZZ-6503148-BR
 69-70 FB, 5 piece kit C9ZZ-630313448K
 69-70 CP, 5 piece kit C9ZZ-650313648K
 71-73 CP, 2 piece D1ZZ-650313648K

CONVERTIBLE WINDSHIELD PILLAR MOLDING



Stainless steel, outer windshield pillar moldings for convertibles. Includes right and left hand side. Daily driver quality to replace missing or damaged originals.

Windshield Pillar Molding, Convertible
64-68 CSZZ-7603136/7B

INTERIOR MOLDINGS

WINDSHIELD FILLER PANEL



These moldings fill the gap between the windshield and the padded dash.

Windshield filler panel
67-68 2 piece filler molding C7ZZ-6504522/3A

PAINT, TOOLS & RESTORATION SUPPLIES

ADHESIVES & CLEANERS

HEADLINER GLUE



This high strength glue comes in an easy to use 4 ounce container with brush applicator built into lid.

Headliner Glue
64-73HLG-1829

INSIDE REARVIEW MIRROR ADHESIVE



Remounts rearview mirror bracket to windshield permanently. Mounting strength is 300 psi. Unaffected by hot and cold temperature variation. Supplied in 0.04 ounce tube.

Inside Rearview Mirror Adhesive
64-73PRO-61067

ACCUMATCH™ INTERIOR PREP



AccuMatch™ Interior Prep: A self-leveling, high-tech adhesion promoter, specifically formulated to fill nicks and scratches.

Interior Prep, AccuMatch™
64-73 PP-2322

SPRAY ADHESIVE



This industrial strength adhesive has many uses throughout the car and shop. Makes permanent or temporary bonds on metal, plastic, paper, wood, cloth, foam rubber and sanding discs, as examples. This easy

to use, non-flammable and water resistant adhesive is a must for installing heater gasket kits. Supplied in a fifteen ounce aerosol can.

Spray Adhesive
64-73CRL-66

ACCUMATCH™ SURFACE CLEANER



AccuMatch™ Surface Cleaner - for properly preparing vinyl and plastic surfaces before application of prep or dye products.

Surface Cleaner, AccuMatch™
64-73 LP-383

ACCUMATCH™ SURFACE SHINE SPONGE



AccuMatch™ Surface Shine Sponge, for easy maintenance of that brand new, "Just Painted" look.

Surface Shine Sponge, AccuMatch™
64-73ACC-SPONGE

SUPER TRIM ADHESIVE SPRAY



Very fast acting contact adhesive designed for two surface applications. Great for vinyl tops, headliners, insulation and padding. Supplied in a 19 ounce aerosol can. From 3M.

Trim Adhesive Spray, Super
64-73 3M-8090

RAGGTOP VINYL CLEANER



THIS is the best cleaner we have found. It is the only cleaner that has been tested and endorsed by HAARTZ and the Ford Motor Company. HAARTZ is the world's largest manufacturer of convertible tops. Safely removes the toughest stains. Over spray will not harm painted finishes. Retards grease, dirt and mildew. Anti-oxidant formula with low PH and no bleach. Leaves no residue. Biodegradable. Must use before applying RT-VP protectant. 16 oz. spray bottle.

Vinyl Cleaner, RAGGTOP
64-73 RT-VC

RAGGTOP VINYL PROTECTANT



This is the only protectant tested and endorsed by HAARTZ, the world's largest manufacturer of convertible tops. The protective film repels stains, acid rain, tree sap, bird droppings, salt, tar, grease and mildew. Contains Cibi Tinuvin 5151, the best ultra violet blocker available. Improves water and stain repellency. Will not streak. Does not include silicone. 16 oz. spray bottle.

Vinyl Protectant, RAGGTOP
64-73 RT-VP

WEATHERSTRIP ADHESIVE



Supplied in five ounce tubes. From 3M.

Weatherstrip Adhesive
64-73 Yellow, not for EPDM rubber ... 3M-8001
64-73 Black, not for EPDM rubber 3M-8008
64-73 Black, for EPDM rubber 3M-8011

LUBRICANTS

LUBRICANT



This is a thick-bodied spray lubricant. Recommended for metal-to-metal moving parts. Clings to sprayed areas for lasting lubrication. Excellent for window regulators and hinges on doors, trunk and hood.

Supplied in 16 ounce spray cans.
Lubricant
64-73 White grease, aerosol canCRL-715

Paint

WE PROUDLY FEATURE AUTHENTIC MUSTANG REPRODUCTIONS FROM SCOTT DRAKE ENTERPRISES!



PAINT & DYE

ACCUMATCH™ INTERIOR DYE



These vinyl dyes feature paint mixed with a quality flex agent. Ours cost a little more, but use true vinyl dyes with flex agents not just paints. Note: Always use vinyl prep LP-383 for better adhesion.

Interior Dye, AccuMatch™

64-65	Light palomino	V-17690
64-65	Medium blue, metallic	V-5747
64-65	Bright red	V-6022
64-66	Light ivy gold, metallic	V-5760
64-66	White	V-5767
64-66	Black	V-946
64-73	Clear coat, finisher	V-CC
65	light blue, metallic	V-5748
65	Medium palomino, metallic	V-5759
66	Light turquoise, metallic	V-5752
66	Medium emberglow, metallic	V-5777
66	Parchment, metallic	V-5779
66-67	Dark red, metallic	V-5773
67	Dark gold, metallic	V-5734
67-68	Light parchment	V-4595
67-68	Dark saddle	V-5738
67-68	Saddle	V-5739
67-68	Dark aqua, metallic	V-5753
67-68	Dark blue, metallic	V-5770
67-68	Light ivy gold, metallic	V-5778
67-73	Black/charcoal, metallic-iridescent	..	V-4464
68	Dark red, semi-gloss	V-5732
68	Dark red, flat	V-5792
68	Dark nugget gold, metallic	V-5798
68-69	Medium ivy gold, metallic	V-5756
68-69	Light nugget gold, metallic	V-5800
69	Dark red, metallic	V-15641
69	Dark ivy, metallic	V-15644
69	Dark red	V-15847
69	Dark ivy	V-15854
69-73	White	V-15855
70	Medium ivy green, metallic	V-15942
70	Vermillion	V-15945
70-73	Medium ginger	V-15939
70-73	Dark ginger	V-15940
71-72	Medium green, metallic	V-16042
71-73	Medium blue, metallic	V-16049
71-73	Medium vermilion, metallic	...	V-16050
73	Medium avocado	V-17023

ACCUMATCH™ INTERIOR PAINT



The AccuMatch(TM) Interior Paints are the result of years of work and perfectly match the original color shades. Each color has been expertly color-matched. Paints feature extra-high pigment

content for superior coverage, and patented fan-pattern nozzle for professional results.

Interior Paint, AccuMatch™

64-65	Light palomino	L-17690
64-65	Medium palomino, metallic	L-5759
64-65	Bright red, semi gloss	L-6022
64-66	Medium ivy gold, metallic	L-5756
64-66	Light ivy gold, metallic	L-5760
64-66	White, semi gloss	L-5767
64-66	Black, semi gloss	L-946
64-70	Medium blue, metallic	L-5747
65-66	Light aqua, metallic	L-5752
65-69	Light blue, metallic	L-5748
66	Medium emberglow, metallic	L-5777
66	Parchment, semi gloss	L-5779
66-67	Dark red, metallic	L-5773
67	Dark gold, metallic	L-5734
67-68	Light parchment	L-4595
67-68	Dark saddle	L-5738
67-68	Saddle, semi gloss	L-5739
67-68	Dark aqua, metallic	L-5753
67-68	Dark blue, metallic	L-5770
67-68	Light ivy gold, metallic	L-5778
67-73	Black charcoal	L-4464
68	Dark red, metallic	L-5732
68	Dark red	L-5792
68	Dark nugget gold, metallic	L-5798
68-69	Light nugget gold, metallic	L-5800
69	Dark red, metallic	L-15641
69	Dark ivy, metallic	L-15644
69	Dark red	L-15847
69	Dark ivy	L-15854
69-73	White, semi gloss	L-15855
70	Ivy green, metallic	L-15942
70	Vermillion	L-15945
70-73	Ginger, semi gloss	L-15939
70-73	Dark ginger	L-15940
71-73	Medium blue, metallic	L-16049
71-73	Medium vermilion, metallic	L-16050
73	Medium avocado	L-17023

ACCUMATCH™ DETAIL BLACK PAINT



Scott Drake Enterprises worked directly with PPG, a Leader in paint technology, to come up with this formula that when cured becomes a very durable chip resistant coating with the correct 15% gloss that

should be used on engine compartments and many chassis components throughout the car. This has quickly become the paint of choice for many Restorers. Please note due to the nature of this product cooler temperatures and high humidity will increase drying times.

Paint, AccuMatch™ Detail Black

64-73	OEM detail black	RP-103
-------	------------------	-------	--------

ACCUMATCH™ DETAIL PAINT



Our detail paints give a natural looking finish to metal surfaces.

Paint, AccuMatch™ Detail

64-73	Steel gray	RP-100
64-73	Cast iron gray	RP-101
64-73	Cast alum.	RP-104

ACCUMATCH™ ENGINE PAINT



AccuMatch™ Engine Paints are a complete line of popular colors and formulas created specifically for engine compartment applications. Engine paints come with higher heat tolerances to resist cracking and

flaking, and are chemical resistant to resist corrosion from common engine compartment fluids such as gasoline and brake fluid.

Formulated to color-match original OEM shades. Withstands temperatures up to 350° F

Paint, AccuMatch™ Engine

64-65	Gold-similar to orig. gold color	EP-1005-A
65	6 cyl., red	EP-1001-A
65	V8, black	EP-1724-A
66-73	Dark blue	EP-1923-A
70-73	Light blue	EP-0046-A

ACCUMATCH™ HI-TEMP PAINT



The Hi-Temp Gray paint from AccuMatch™ Products, is formulated specifically to withstand high engine compartment temperatures (up to 1200°. Leaves pieces with a natural cast-iron finish with less

applications due to its extra-high pigment content. • Formulated to withstand extreme temperatures up to 1200°F • Perfect for headers & exhaust manifolds

Paint, AccuMatch™ Hi-Temp

64-73	Gray	RP-102
-------	------	-------	--------

ACCUMATCH™ MACH 1 MOLDING PAINT



AccuMatch™ Dark Argent, Specialty Application Spray Paint (12 oz can). 1970 Mach 1 Molding • Specifically made for the 1970 Mach 1 grill and rocker panels

Paint, AccuMatch™ Mach 1 Molding

70	Mach 1 molding, dark argent	L-17500
----	-----------------------------	------	---------

ACCUMATCH™ MUSTANG GRILLE PAINT



AccuMatch™ Gun Metal Blue, Specialty Application Spray Paint (12 oz can). 1964-65 Mustang Grill OEM • Gives an OEM accurate, concours-correct, gun-metal finish

Paint, AccuMatch™ Mustang Grille

64-65	L-17530
-------	-------	-------	---------

SHOP WITH CONFIDENCE! WE OFFER SUPERIOR-QUALITY PARTS FOR ALL YOUR MUSTANG RESTORATION NEEDS.

ACCUMATCH™ POWER STEERING PUMP PAINT



AccuMatch™ Blue, Specialty Application Spray Paint (12 oz can). 1965-69 Power Steering Pump • Color formulated to match original OEM Power Steering Pump color.

Paint, AccuMatch™ Power Steering Pump
65-69L-17520

ACCUMATCH™ WHEEL PAINT



AccuMatch™ Wheel Paints are specifically formulated to correctly match the most popular wheel colors, including Charcoal Gray and a Classic Argent Gray. • Gives a smooth color-correct finish to wheel surfaces

• Provides protection against corrosion and wear • Available in popular restoration colors

Paint, AccuMatch™ Wheel
64-73 Classic argent grayL-17510
65-67 Styled steel charcoal grayL-17540

TAIL LIGHT PANEL PAINT



Dark argent paint, perfect for tail light panels.

Paint, Tail Light Panel
67-68L-17550

MARKAL PAINT STICK



Special paint sticks which were used by FORD at the assembly plants to mark fender aprons, radiator support, transmission, rear end housing, sheet metal, glass and many other parts. These sticks are the attention to detail that wins shows.

Paint Stick, Markal
64-73 2 sticks, white & yellowMPS-2
64-73 12 pack MPS-KIT

EXTERIOR TOUCH UP PAINT



These convenient 12 ounce aerosol cans are perfect for minor touch ups on the daily driver. Great for lower valances, door jambs, underhood, inside trunk area and misc. spot repair. These are made from the

original paint supplier to Ford in the sixties using the exact same lacquer formulas that Ford used. The 3rd digit in our part number is Ford's paint code that you will find on your door data tag. Please note that due to the fact that most cars have been repainted and there are many types of paint (synthetic enamel, acrylic enamel, lacquers, clear coats, etc.) plus deterioration and fading of older paint we can not guarantee a match. Note: Paint is not returnable.

Paint, Exterior Touch Up

64	Pagoda green	PC-B-PG
64	Guardsman blue	PC-F-GB
64	Skylight blue	PC-Y-SK
64-65	Poppy red	PC-3-PR
64-65	Twilight turquoise	PC-5-TT
64-65	Phoenician yellow	PC-7-PY
64-65	Silver smoke gray	PC-K-SS
64-65	Prairie bronze	PC-P-PB
64-66	Ivy green	PC-R-IG
64-67	Springtime yellow	PC-8-SY
64-67	Vintage burgandy	PC-X-VB
64-71	Raven black	PC-A-RB
64-73	Wimbeldon white	PC-M-WW
65	Champaigne beige	PC-I-CB
66	Signalflare red	PC-5-SR
66	Silver blue	PC-Y-SB
66-67	Silver frost	PC-4-SF
66-67	Arcadian blue	PC-F-AB
66-67	Nightmist blue	PC-K-NB
66-67	Sauterne gold	PC-Z-SG
66-68	Tahoe turquoise	PC-U-TT
66-70	Candyapple red	PC-T-CR
67	Dark moss green	PC-Y-DG
67-68	Pebble beige	PC-6-PB
67-68	Lime gold	PC-I-LG
67-68	Diamond blue	PC-N-DB
67-68	Brittany blue	PC-Q-BB
67-69	Acapulco blue	PC-D-AB
68	Presidential blue	PC-X-PB
68-69	Royal maroon	PC-B-RM
68-69	Gulfstream aqua	PC-F-GA
70-72	Grabber blue	PC-J-GB
71-73	Bright red	PC-3-BR

ACCUMATCH™ SELF ETCHING PRIMER



AccuMatch™ Self Etching Primers. Acrylic resin formula gives excellent adhesion to aluminum, bare metal, and other prepared surfaces.

Primer, AccuMatch™ Self Etching

64-73	Gray	RP-200
64-73	Red oxide	RP-201
64-73	Black	RP-202
64-73	Gray - weld through	RP-203

ACCUMATCH™ FILLER PRIMER



AccuMatch™ Filler Primer, Gray (18 oz) • Highest solid content for filling surface blemishes • Quick drying primer provides extra hard sandable surfaces • Creates superior base for maximum top-coat adhesion

Primer, AccuMatch™ Filler

64-73	RP-204
-------	-------	--------

ACCUMATCH™ PRO GRADE PRIMER



AccuMatch™ Pro-Grade Primers (12 oz) • Creates superior base for maximum top-coat adhesion • Seals surface for excellent durability

Primer, AccuMatch™ Pro Grade

64-73	Gray	RP-206
64-73	Red oxide	RP-207

ACCUMATCH™ ZINC PHOSPHATE PRIMER



AccuMatch™ Zinc Phosphate Primer, Gray (12 oz) • Chemically bonds to aluminum and other metals • Two component polyurethane epoxy provides exceptional protection against rust and moisture

Primer, AccuMatch™ Zinc Phosphate

64-73	yellow/green	RP-205
-------	--------------	-------	--------

ACCUMATCH™ UNDERCOATING



AccuMatch™ automotive undercoatings are designed for complete undercarriage protection and sound-deadening. Available in either a standard asphalt-based formula, and also in our new rubberized formula for extra protection and sound-deadening properties. Undercoatings come in extra large 15oz cans for even the biggest jobs.

Undercoating, AccuMatch™

64-73	Black, rubberized	3M-8883
64-73	Black, rubberized	RP-300
64-73	Black, asphalt	RP-301

Paint

WE PROUDLY FEATURE AUTHENTIC MUSTANG REPRODUCTIONS FROM SCOTT DRAKE ENTERPRISES!



SEALANTS

BEDDING AND GLAZING COMPOUND



This non-hardening, water resistant formula is designed for sealing windshields and rear windows on all cars using rubber gaskets. This bedding compound can be used

between glass and metal, or between glass and rubber. Locks out dust and air, remains flexible and resilient, can be used for installing water shields. Supplied in 11 ounce tubes.

Bedding And Glazing Compound
64-73 3M-8509

HIGH TEMPERATURE SILICONE



This red RTV silicone bonds to rubber, aluminum, steel and iron. Ideal for use on timing covers, oil pans, thermostat housings and valve covers. This special formula is not affected by oils, grease,

transmission fluid, antifreeze or temperatures up to 500 degrees. Form your own gasket, replaces paper, felt, rubber and cork gaskets. Supplied in 2.8 oz. tubes with nozzle.

High Temperature Silicone
64-73CRL-55 RED

STRIP BODY CAULKING



Used to seal openings in the car body. Non-hardening, waterproof and will not shrink.

Ideal for seams, cracks and joints. Especially useful when hanging fenders and mounting fuel tanks for proper sealing. Supplied in a box of 60 one-foot lengths. Black only.

Strip Body Caulking
64-73 3M-8578

WINDSHIELD AND BODY SEALANT



This non-hardening, water resistant formula is designed for sealing windshields and rear windows on all cars using rubber gaskets. This

bedding compound can be used between glass and metal, or between glass and rubber. Locks out dust and air, remains flexible and resilient, can be used for installing water shields. Supplied in 11 ounce tubes.

Windshield And Body Sealant
64-73 Non-hardening CRL-7708

WINDSHIELD SEALANT



This formula cures into a tough, flexible, rubbery bead. Excellent adhesion to glass and all metals. Can be water tested

in minutes. Works well for sealing drip rails in addition to glue in windshields.

Windshield Sealant
64-73CRL-7711

TOOLS

CONVERTIBLE TOP SWITCH BEZEL TOOL



New from Scott Drake. This dedicated tool is perfect for installing or removing the chrome bezel on our cv top switch.

Convertible Top Switch Bezel Tool
67 T-67

DOOR HANDLE CLIP REMOVER



Removes special retaining clip on early door handles and window cranks. Stamped steel construction.

Door Handle Clip Remover
64-65T-87600

DOOR HINGE SPRING COMPRESSOR



This finger saver, makes installing the spring on the lower hinge quick and easy. For use only on a bench (off-car) rebuild and ALWAYS wear eye protection!

Door Hinge Spring Compressor
64-67T-87675

DOOR PANEL REMOVER



Stamped steel construction. Allows removal of door panels with out causing damage to panel or fasteners.

Door Panel Remover
64-73T-87650

EXTERNAL WIPER BEZEL NUT TOOL



Specially designed for removing or installing bezel nuts, without risk of scratching or damaging bezel or paint.

External Wiper Bezel Nut Tool
64-65 T-120

FOG LIGHT SWITCH BEZEL TOOL



Another specialized tool used to install or remove the chrome bezel on the fog lamp switch. Helps prevent scratches from using improper tools.

Fog Light Switch Bezel Tool
65-67T-65

IGNITION BEZEL TOOL



Don't scratch that new bezel with a screw driver. A dedicated tool made by Scott Drake.

Ignition Bezel Tool
67-68 T-100
69 T-109

MOLDING REMOVER



Great for windshield and rear window moldings. Stamped steel with red coated handle.

Molding Remover
64-73T-87800

TOP VENT RIVET TOOL



Finally the perfect tool for that tough little job. Includes 1 pair top seals and 4 rivets.

Top Vent Rivet Tool
64-73 T-225

GLASS RUN TOP VENT SEAT TOOL



Time saving tool which removes old top vent window seals and installs new semi-tubular rivets with original looking results.

Top Vent Seat Tool, Glass Run
64-66 T-221

WIPER BEZEL STEM NUT TOOL



Special tool designed to insert into wiper bezel stem nut used for assembly or disassembly. Will not damage nut.

Wiper Bezel Stem Nut Tool
64-66 T-110

RUBBER PARTS & WEATHER STRIPPING

EXTERIOR PADS AND SEALS

ANTENNA BASE GROMMET



High quality compression molded neoprene rubber. Fits round base antennas.

Antenna Base Grommet

64-67C5ZZ-18A813-A

BACK UP LIGHT LENS GASKET



Molded sponge, good fit. Seals lens to housing.

Back Up Light Lens Gasket

65-70C5ZZ-15510-A

BACK UP LIGHT PAD



Molded Black rubber, good fit. Seals housing to rear valance panel.

Back Up Light Pad

64-66C5ZZ-15533-A/B
67-70C7ZZ-15533-A

BASIC REPAINT KIT



This kit features some of the basics parts that are replaced during a basic repaint. Includes hood bumpers, door bumpers, trunk bumpers, tail lamp and lens gaskets, door

handle pads, backup lamp pads, parking lamp pads, cowl to hood seal, antenna pad, trunk housing pad and quarter cap seals.

Basic Repaint Kit

64-66KIT-RUB-3

DOOR AND QUARTER SEAL SCREW



Used to secure the seals both on the quarter panel and on the rear of the door window seal. Black oxide finish.

Door And Quarter Seal Screw

64-73 Bulk, sold in bags of 10052718-SMK
65-68 Set of 2252718-S

FRONT DOOR TO WINDOW SEAL

Made from a high quality rubber. These feature a steel insert molded inside. Fits on rear door edge. See Hardware category for screws.

Door To Window Seal, Front



64-66
C5ZZ-6520588/9B



67: Early 67 Cougar
C7ZZ-6520588/9A



67-68: Late 67 Cougar
C7ZZ-6520588/9B



69-70
C9ZZ-6520264/5A

FENDER EXTENSION SEAL



Small rubber extrusion which fits between headlight assembly and front fender edge. This cures chipping paint problems.

Fender Extension Seal

67-70C7ZZ-13044

FENDER SPLASH SHIELD KIT



Scott Drake splash shield kits include the rubber seals and mounting hardware, for use with the customer's original

splash shield plates or our new standard splash shield plates.

Fender Splash Shield Kit

64-66C5ZZ-16A572-A
67-68C7ZZ-16A572-A

FENDER TO BODY PILLAR PAD



These pads fit near the cowl to prevent rattling or movement of the fenders against the body. Square, two required per car.

Fender To Body Pillar Pad

65-66C5ZZ-16246

HOOD SCOOP SEAL



Fits behind hood scoop grill.

Hood Scoop Seal

69-70C9ZZ-16666

HOOD TURN SIGNAL LIGHT GASKET



Hood Turn Signal Lamp Gaskets. Sold in Pairs.

Hood Turn Signal Light Gasket

67-68C7ZZ-13A368

LICENSE PLATE BUMPER



These little bumpers remove big rattles. Fits front or rear

valances. 1964-68 front and 1964-70 rear.

License Plate Bumper

64-70375838-51

LICENSE PLATE LIGHT LENS GASKET



Precision die-cut gaskets from the original material used on the Mustang.

License Plate Light Lens Gasket

65-73C7AZ-13568-A

MARKER LIGHT LENS GASKET



These parts are precision die-cut for a great fit the first time.

Marker Light Lens Gasket

68C8ZZ-15A209
69 Set of 4C9AZ-15A447
70D0ZZ-15A209
71-73D1ZZ-15209

OUTSIDE DOOR HANDLE PAD



Fit between door handle and door body panel. Injection-molded plastic just like the original. Sold in complete sets only. 4 piece sets.

Outside Door Handle Pad

64-70 Does not fit 67-68C0DZ-6422428/9K
67-68C7ZZ-6522428/9K

QUARTER PANEL DRAIN PLUG

Durable E.P.D.M. rubber for the most weathered part of the car, the inside rear quarter panels. 1967 - 1968 features a steel insert, like the originals.

Quarter Panel Drain Plug



64-66
C40Z-62103A58-C



67-68
C7ZZ-6511202-A

Rubber

WE PROUDLY FEATURE AUTHENTIC MUSTANG REPRODUCTIONS FROM SCOTT DRAKE ENTERPRISES!



QUARTER PANEL EXTENSION SEAL



Installs between quarter panels and extensions to prevent paint from cracking. Added after early production models showed problems in the

split line between the two parts.

Quarter Panel Extension Seal

64-66	C5ZZ-6527802-C
67-68	C7ZZ-6527802-C
69-73	C9ZZ-6527802-C

QUARTER PANEL GRILLE GASKET



These gaskets are for the grille panels on the quarter panel. Sets of four each.

Quarter Panel Grille Gasket

67	C7ZZ-65291C80-C
----	-------	-----------------

QUARTER WINDOW TO BODY SEAL

Made by Scott Drake, these Seals feature all the original details. Made of Quality rubber molded around a steel insert.

Quarter Window To Body Seal



64-66: CP & CV
C5ZZ-6528182/3



67-68: CP & CV
C7ZZ-6528182/3



69-70: FB
C9ZZ-6328182/3A



69-70: CP & CV
C9ZZ-6528182/3B



71-73: CP & CV
D1ZZ-6528182/3B

REAR LICENSE PLATE DUST SHIELD



These rubber insulators prevent dust from accumulating on the surface of the license

plate by stopping the airflow between the bumper and the rear valance.

Rear License Plate Dust Shield

67-68	C7ZZ-6540427
69-70	C9ZZ-6540427

SPOILER GASKET



Our gaskets are made of high quality EPDM rubber to provide years of service. Not just a flat piece of rubber. These pads are

formed to fit the slope of the trunk lid. Sold in matching pairs.

Spoiler Gasket

69-73	C9ZZ-6344228/9A
-------	-------	-----------------

TAIL LIGHT HOUSING GASKET



This gasket goes between the tail lamp housing and the body of the car on 1964 through 1966 Mustangs.

Tail Light Housing Gasket

64-66	C5ZZ-13420-A
67-68	C7ZZ-13420-A
69	C9ZZ-13420-A

TAIL LIGHT HOUSING TO BODY SEAL



Thick black molded mounting pads which protect and seal trunk from water and dirt.

Tail Light Housing To Body Seal

67-68	C7ZZ-13520
69	C9ZZ-13520
70	D0ZZ-13520
71-73	D1ZZ-13520

TAIL LIGHT LENS GASKET



Precision die-cut gaskets for hassle-free installation. Made from the original type of material in each case.

Tail Light Lens Gasket

64-66	C5ZZ-13461-B
67	Cougar & Shelby C7WY-13461
67-68	C7ZZ-13461-A
68-70	Shelby & Cal Special C4SZ-13461-A
69	C9ZZ-13461-A

TRUNK LID BUMPER



Feature perfect shape, detail, and resilience in the material. Injection molded in E.P.D.M.

rubber specifically for the Mustang, not a universal type.

Trunk Lid Bumper

64-66	C5ZZ-6543634
67-70	C7ZZ-6543634

TRUNK LOCK CYLINDER HOUSING PAD

Precision molded pad to place behind the cylinder sleeve flange. Seals between the cylinder and trunk surface.

Trunk Lock Cylinder Housing Pad



64-66
C5ZZ-6543625-B



67-73: Trunk & door locks
C7AZ-6543625-A

TRUNK SEAL



Perfect reproductions of the original. Made from long lasting E.P.D.M. sponge rubber.

Trunk Seal

64-70	CP & CV	COMB-6443720-C
65-66	FB	C5ZZ-6343720-B
67-68	FB	C7ZZ-6343720-B
69-70	FB	C9ZZ-6343720-A
69-70	Shelby CV	S9MS-7643720-A
71-73	All body styles	D2WY-6543720-A

VENT SEAL EDGE RIVET



Correct black oxide semi-tubular rivet.

Vent Seal Edge Rivet

64-66	Set of 10	351603-5
-------	-----------	-------	----------

WINDSHIELD PILLER PAD

Windshield Piller Pad

67-68	RH	C7ZZ-6503598-AQ
67-68	LH	C7ZZ-6503599-AQ

EXTERIOR WEATHER STRIP

DOOR AND QUARTER SEAL SCREW



Used to secure the seals both on the quarter panel and on the rear of the door window seal. Black oxide finish.

Door And Quarter Seal Screw

64-73	Bulk, sold in bags of 100	52718-SMK
65-68	Set of 22	52718-5

FRONT DOOR GLASS RUN CHANNEL



Vertical channel which runs behind vent window that door glass slides in.

Features original type

mohair inside channel, mounting bracket and stainless steel trim.

Door Glass Run Channel, Front

- 64-66 USA CSZZ-6521538/9A
- 64-66 Import, RH CSZZ-6521538-A
- 64-66 Import, LH CSZZ-6521539-A

FRONT DOOR GLASS RUN INSERTS



Insert to replace worn rubber and felt channel guide for door glass. Features original looking felt. Top molded pieces are bonded securely and has steel inserts for added strength.

Door Glass Run Inserts, Front

- 67-68 C7ZZ-6521546/7A

QUARTER WINDOW SEAL



Made with long lasting E.P.D.M. rubber. Features the same detail as the originals. A steel insert is molded inside.

Quarter Window Seal

- 64-68 CP, RH CSZZ-6530146-B
- 64-68 CP, LH CSZZ-6530147-B
- 64-68 CV, RH CSZZ-7630146-B
- 64-68 CV, LH CSZZ-7630147-B
- 69 CP & CV, RH C9ZZ-65214A14-A
- 69 CP & CV, LH C9ZZ-65214A15-A
- 71-73 FB, RH D1ZZ-6330146-A
- 71-73 FB, LH D1ZZ-6330147-A
- 71-73 CP & CV, RH D1ZZ-6530146-A
- 71-73 CP & CV, LH D1ZZ-6530147-A

69-70 FASTBACK QUARTER WINDOW SEAL



Quarter Window Seal, 69-70 Fastback

- 69-70 FB C9ZZ-6330222-5

DOOR GLASS TO QUARTER WINDOW SEAL



Made with long lasting E.P.D.M. rubber. Features the same detail as the originals. A steel insert is molded inside.

Quarter Window Seal, Door Glass To

- 69-70 FB, RH D0ZZ-63214A14-R
- 69-70 FB, LH D0ZZ-63214A15-R

REAR VERTICAL GLASS RUN REPAIR KIT



Original type style mohair/felt which covers run channel. Includes adhesive backing. Repairs both sides, Channel not included.

Rear Vertical Glass Run Repair Kit

- 64-66 CSZZ-6521508-RK

REAR WINDOW SEAL

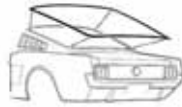

All of the below are made with superior quality E.P.D.M. rubber and feature transfer molded corners like the originals.

Rear Window Seal

- 64-68 CP CSZZ-6542084-A
- 65-66 FB CSZZ-6342084-A
- 67-68 FB C7ZZ-6342084-A
- 69-70 FB C9ZZ-6342084-A
- 69-70 CP D0ZZ-6542084-A
- 71-73 FB D1ZZ-6342084-A
- 71-73 CP D1ZZ-6542084-A

ROOF RAIL SEAL



These are the best on the market. We welcome comparison. Made from a quality neoprene extrusion

with transfer molded ends, not glued ends like some competitors. Includes fastening pins.

Roof Rail Seal

- 64-66 CP CSZZ-6551222/3C
- 65-66 FB CSZZ-6351222/3C
- 67-68 FB C7ZZ-6351222/3A
- 67-68 CP C7ZZ-6551222/3C
- 69-70 FB C9ZZ-6351222/3C
- 69-70 CP C9ZZ-6551222/3A
- 71-73 CP D1ZZ-6551222/3A

ROOF RAIL WEATHERSTRIP CLIP



Metal clip to secure weatherstrip to roof rail.

Roof Rail Weatherstrip Clip

- 71-73 For use at 1/4 window D1ZZ-6522204
- 71-73 For use at door D1ZZ-6522244

TOP VENT WINDOW SEAL



Made from compression molded E.P.D.M. rubber with cadmium plated steel inserts molded inside. Includes rivets. Sold in sets.

Top Vent Window Seal

- 64-66 CSZZ-6521774/5A

TRUNK WHEELHOUSE SEAM COVER



Rubber strip to clean up the sharp edge of the wheel housing seam. Important for protecting luggage and other easily damaged

cargo. Fits left hand wheelhouse flange.

Trunk Wheelhouse Seam Cover

- 64-68 CSZZ-6531466-A

VENT WINDOW DIVISION BAR SEAL



Offers a perfect fit with a steel insert molded into high quality E.P.D.M. rubber. Mounts on back side of vent window bar. Now

original type rivets included.

Vent Window Division Bar Seal

- 64-66 CSZZ-6521450-A

VENT WINDOW FRAME TO DOOR SEAL



Seals between chrome vent frames and door on exterior side.

Vent Window Frame To Door Seal

- 67-68 C60Z-6322280

VENT WINDOW SEAL



Our high quality Scott Drake reproduction vent seals offer your customers the finest molded rubber pieces available.

Vent Window Seal

- 65-66 RH & LH CSZZ-6521448/9B
- 67-68 RH C7ZZ-6521448-AR
- 67-68 LH C7ZZ-6521449-AR

VENT WINDOW SEAL KIT



Convenient time saving kit offers you everything to complete vent seal installation. Kit features vents seals, top vent seals, back edge

vent seals, and all rivets. Check out our rivet tools to make the job easier.

Vent Window Seal Kit

- 64-66 KIT-RUB-5

WE PROUDLY FEATURE AUTHENTIC MUSTANG REPRODUCTIONS FROM SCOTT DRAKE ENTERPRISES!



VENT WINDOW TO DOOR SEAL



These high quality vent window seals are the first on the market to replace the original Ford part exactly.

This is the small seal

at the front of the door and next to the door weatherstrip.

Vent Window To Door Seal

67-68 C7Z-6522332/3

WEATHERSTRIP FASTENER



Made exactly like the originals. Black plastic.

Weatherstrip Fastener

64-68 Set of 4 C1AB-6220807-A

WINDOW CHANNEL STRIP



We proudly carry the full line of Re-Pops window channel strips. Rest assured that these are the highest quality on the market.

These window channel strips have the correct bends and staples. They also come with easy to understand instructions and a drill bit for installation.

Window Channel Strip

- 65-66 FB, economy C5Z-6321458/9E
- 65-66 FB C5Z-6321458/9S
- 64-66 CP & CV, economy C5Z-6521458/9E
- 65-66 CP & CV C5Z-6521458/9S
- 67-68 FB C7Z-6321458/9S
- 67-68 CP C7Z-6521458/9S
- 67-68 CV C7Z-7621458/9S
- 69-70 FB C9Z-6321458/9S
- 69-70 CP C9Z-6521458/9S
- 69-70 CV C9Z-7621458/9S
- 71-73 FB D1Z-6321458/9S
- 71-73 CP D1Z-6521458/9S
- 71-73 CV D1Z-7621458/9S

WINDOW SEALER



Used to water-proof windshield and rear window. Silicone type sealer. Best suited for glue in windshields.

Window Sealer

- 64-73 Non-hardening CRL-7708
- 69-73 Silicone based 3M-8606

WINDSHIELD SEAL



Made from superior quality E.P.D.M. rubber, excellent detail, features spliced transfer

molded corners like originals. These offer quality we stand behind. No others compare.

Windshield Seal

64-68 CSZ-6503110-A

INTERIOR RUBBER

ACCELERATOR PEDAL



These steel reinforced parts are molded from high quality rubber for a long life and great appearance.

Accelerator Pedal

- 64-68 w/ stainless trim C5Z-9735-D
- 69-70 w/out trim C9Z-9735-D

ASH TRAY BUMPERS



This is not a generic bumper. This one is built by Drake and is of the best quality and detail. An exact reproduction.

Ash Tray Bumpers

64-66 380369-5

AUTOMATIC TRANSMISSION SHIFT HOUSING PLUG



Molded rubber plug, seals access hole in the side of shift housing.

Automatic Transmission Shift Housing Plug

65-73 C5Z-7C147-B

BRAKE AND CLUTCH PEDAL PAD



Sold as a matching set for the clutch and brake pedals for manual transmission cars.

High quality EPDM rubber will look great for years.

Brake and Clutch Pedal Pad

65-68 5.0 CSZ-2457624-50

BRAKE PEDAL PAD

Made by Scott Drake with exact detail of the original. Compression molded rubber. Disc brake versions include stainless steel center trim.

Brake Pedal Pad



64-67: w/ power drum
CSZ-2457-E



64-67: drum, auto.
CSZ-2457-F



65-73: drum, manual
CSZ-2457-G



68-73: drum, automatic
C60Z-2457-A

DISC BRAKE PEDAL PAD

These reproduction pads are high quality replacements for worn or missing original pads.

Brake Pedal Pad, Disc



65-67: disc, auto.
CSZ-2454-C



65-73: disc, manual
CSZ-2454-D



68-73: disc, auto.
D3Z-2454-A

BRAKE PEDAL PAD TRIM



Replacement brake pedal pad trim.

Brake Pedal Pad Trim

- 65-67 auto. CSZ-2A487-B
- 65-73 manual D1Z-2A487-B
- 68-73 auto. C60Z-2A487-A

CLUTCH PEDAL PAD

These reproduction pads are high quality replacements for worn or missing original pads.

Clutch Pedal Pad



65-68
CSZ-7A624-B



69-73
C9Z-7A624-A

CLUTCH PEDAL PAD TRIM



Stainless steel.

Clutch Pedal Pad Trim

- 65-68 CSZ-7B544-A
- 69-73 C9Z-7B544-A

DOOR LIGHT GASKET



This pair of gaskets seal the door lamps to the door on Mustangs.

Door Light Gasket

- 65-66C5Z-13790
- 67-68C90Z-13790-A

FASTBACK SEAT BUMPERS

These parts are pressure molded in high density E.P.D.M. rubber and are an exact fit. **Fastback Seat Bumpers**



- 65: Early 65
372262-S



- 65-66: Set of 4
372260-S



- 65-70: Late 65
C6Z-6362426-A

FASTBACK SEAT LATCH BUMPER



This rubber bumper is used to keep the seat from rattling and also prevent damage when the seat is folded out for use.

Fastback Seat Latch Bumper

- 65-66C5Z-63613B30
- 67-70C7Z-63613B30/1

FIREWALL INSULATION FASTENERS



Firewall Insulation Fasteners

- 64-73 Plastic replacement357036-S100-P
- 68-73 RubberC8Z-6501691

GLOVE BOX DOOR BUMPERS



These are not off the shelf universal bumpers. These are the correct ones. Authentic in shape and detail.

Glove Box Door Bumpers

- 64-66375838-S
- 67-70380239-S

HEADLIGHT DIMMER SWITCH

COVER PAD



Molded rubber cover which fits over headlamp dimmer switch.

Headlight Dimmer Switch Cover Pad

- 65-73C5Z-13533

INSTRUMENT LENS ANTI-RATTLE

PAD



This kit takes away all the rattles caused from hardened and missing pads.

Instrument Lens Anti-Rattle Pad

- 64-65 10 piece setC4DZ-10856
- 66 13 piece setC6DZ-10856

PARKING BRAKE PEDAL PAD



Made by Scott Drake, this Parking Brake Pad is an exact copy of the original. Molded from wear resistant rubber for years of use.

Parking Brake Pedal Pad

- 69-73 Note: Will not fit 1970 Mustang or Cougar
C9Z-2454-A

PARKING BRAKE PEDAL PAD TRIM



Made from stainless steel, just like the originals.

Parking Brake Pedal Pad Trim

- 69-73 Note: Will not fit 1970 Mustang or Cougar
C9Z-2A487-C

RUBBER GROMMET KIT



A time saving and complete grommet and rubber plug set. May or may not be exact fit for Cougar.

Rubber Grommet Kit

- 64-66C5Z-6511135-K
- 67-68C7Z-6511135-K
- 69-70C9Z-6511135-K
- 71-73D1Z-6511135-K

SEAT ACCESS HOLE PLUG



Molded rubber. Ours feature the right details including stamped engineering numbers on top.

Seat Access Hole Plug

- 64-73377901-S

SHOCK ACCESS HOLE PLUG



Quality molded rubber. Features correct engineering numbers stamped on top.

Shock Access Hole Plug

- 64-68378923-S

SUN VISOR TIP



Soft rubber tips to go over the ends of the sun visor rods.

Sun Visor Tip

- 64-73D1DZ-6204115-A

TENSION ROD ANTI-RATTLER



Designed to prevent vibration noise, these rubber sleeves slide over the trunk lid hinge tension rods.

Tension Rod Anti-Rattler

- 64-68C5Z-6545028

WASHER PUMP PEDAL PAD



Great reproduction of the original, with crisp detailing in the rubber.

Washer Pump Pedal Pad

- 67-68C7Z-17664-P

UNDERHOOD RUBBER

ACCELERATOR ROD GROMMET



This piece seals the accelerator rod where it passes through the firewall. Stops cold air and wind noise from entering the interior of the car.

Accelerator Rod Grommet

- 64-66C4AZ-9793-A
- 67-68C60Z-9793-A

COWL TO HOOD SEAL



Our cowl to hood seals have been engineered to fit right. Each one features perfect detail, cross sections match originals. Fasteners are

installed, or have pre-punched retainer holes when needed.

Cowl To Hood Seal

- 64-66C5Z-16740-A
- 67-68C7Z-16740-A
- 69-70C9Z-16740
- 71-73D1Z-16740

WE PROUDLY FEATURE AUTHENTIC MUSTANG REPRODUCTIONS FROM SCOTT DRAKE ENTERPRISES!



FIREWALL TO HOOD BUMPER



The Ford answer to anti-rattle on the hoods of the later Mustangs. Sold with attaching screws, and made to look

exactly like the originals. 2 piece set

Firewall To Hood Bumper

- 69-70 380478-S2
- 71-73 380478-S3

FUEL LINE GROMMET



This is the grommet that protects the fuel line as it passes through the driver's side inner fender panel.

Fuel Line Grommet

- 64-67 5/16" CSZZ-9288
- 67-70 3/8" C7ZZ-9288
- 71-73 3/8" D1ZZ-9288

GENERATOR SPLASH SHIELD

Die cut sheet rubber. Our reproduction splash shield is an exact duplicate of the original rubber boot.

Generator Splash Shield



- 64: Outer
C40Z-10170-C



- 64: Boot
C40Z-10170-D

BULK HOOD BUMPER

All of our hood bumpers feature detail which others don't have. Produced from high quality rubber.

Hood Bumper, Bulk



- 64-68: Bulk
C4DZ-16758-B



- 67-68: Bulk, rear
C7WY-16758-B



- 69-70: Bulk
C60Z-16758-A



- 71-73: Bulk
D1ZZ-16758-A

HOOD BUMPER KIT



All of our hood bumpers feature detail which others don't have. Produced from high quality rubber. Packaged in a complete set of 4 bumpers.

Hood Bumper Kit

- 64-66 Set of 4 CSZZ-16758-K
- 67-68 Set of 4 C7WY-16758-K
- 69-70 Set of 4 C60Z-16758-K
- 71-73 Set of 4 D1ZZ-16758-K

DELUXE HOOD BUMPER KIT



All of our hood bumpers feature detail which others don't have. Produced from high quality rubber. Packaged in a complete 6 piece set, for one car.

Hood Bumper Kit, Deluxe

- 64-66 dlx., 6 piece kit CSZZ-16758-DLXK
- 67-68 dlx., 6 piece kit C7WY-16758-DLXK
- 69-70 dlx., 6 piece kit C60Z-16758-DLXK
- 71-73 dlx., 6 piece kit D1ZZ-16758-DLXK

HOOD SEAL RETAINER CLIP



Stamped steel clips and mounting hardware included. Painted black. Kit includes 2 retaining clips and 4 mounting screws.

Hood Seal Retainer Clip

- 64-66 CSZZ-16A670-A

RADIATOR SUPPORT TO HOOD BUMPER

Durable E.P.D.M. rubber. Gold Cadmium plated shaft and nut.

Radiator Support To Hood Bumper



- 64
CSZZ-16763-A



- 65-73
CSZZ-16763-B

RADIATOR SUPPORT TO HOOD SEAL



Quality E.P.D.M. rubber extrusion. This kit also includes staples. Fits all 6 cylinder and most big blocks

Radiator Support To Hood Seal

- 64-70 C4DZ-16A238-A

RAM AIR HOOD SEAL



The thick rubber seal that fits between the air cleaner and the hood scoop.

Ram Air Hood Seal

- 71-73 Proper thickness D1ZZ-9624

UNDER HOOD SEAL KIT



Features cowl to hood seal, hood bumpers and radiator support to hood bumpers.

Under Hood Seal Kit

- 64-66 KIT-RUB-2

SHEET METAL & BODY PARTS

CHASSIS

COMPLETE FLOOR PAN



Original gauge sheet metal is used in the manufacturing of this beautiful part. Made to exact specifications for a perfect fit. Finished

in a smooth semi-gloss black paint. Includes lower reinforcement pans on convertible, floor pan plugs and seat access hole plugs.

Floor Pan, Complete

- 64-68 CP & FB M107-8-FFCP
- 64-68 CV, inc. lower pans M3648
- 69-70 All body styles M107-8-FFSTD

FULL LENGTH FLOOR PAN



Replace the whole side at once and save time. They are exact replacements for 1964-68. 1969-70 Mustangs have different ribbing

configurations. 1971-73 cars can use the 64-73 floor pans but requires modifications, therefore we recommend our new correct 71-73 pans.

Floor Pan, Full Length

- 64-73 CP & FB, 24"Wx60"L, LH M107-8ALH
- 64-73 CP & FB, 24"Wx60"L, RH M107-8ARH
- 64-73 CV, 24"Wx60"L, LH M107-8BLH
- 64-73 CV, 24"Wx60"L, RH M107-8BRH
- 71-73 All, LH M207-8LH
- 71-73 All, RH M207-8RH

Sheet Metal

LONG FRONT FLOOR PAN



These floor pans will fit 1964 - 1973. They are exact replacements for 1964 - 1968. 1969 - 1970 cars have different ribbing configurations. 1971 - 1973 cars can use but requires modifications.

Floor Pan, Long Front

- 64-73 LH, 23"Wx38 3/4"L M107LH
- 64-73 RH, 23"Wx38 3/4"L M107RH

SHORT, FRONT FLOOR PAN



These floor pans will fit 1964 - 1973. They are exact replacements for 1964 - 1968. 1969 - 1970 cars have different ribbing configurations. 1971

- 1973 cars can use but requires modifications.

Floor Pan, Short, Front

- 64-73 LH, 24"Wx22 1/2"L M106LH
- 64-73 RH, 24"Wx22 1/2"L M106RH

FRONT FLOOR EXTENSION



Made from 19 gauge steel. Extension for where the front floor and the firewall pedal area end up. M126LH needs

slight trimming on 1969-1970 if using the original torque box. No trimming is required if using a reproduction torque box, M114A.

Floor Extension, Front

- 64-68 LH M126LH
- 64-68 RH M126RH

REAR FLOOR PAN



These floor pans will fit 1964 - 1973. They are exact replacements for 1964 - 1968. 1969 - 1970 cars have different ribbing configurations. 1971

- 1973 cars can use but requires modifications.

Floor Pan, Rear

- 64-73 LH, 23 1/2"Wx21"L M108LH
- 64-73 RH, 23 1/2"Wx21"L M108RH

REAR FLOOR EXTENSION



Extension from rear floor to trunk. Specifically designed for coupes and Fastbacks, but will work for

convertibles with slight trimming.

Floor Extension, Rear

- 64-68 LH M131LH
- 64-68 RH M131RH

FLOOR PAN SUPPORT



Heavy duty floor support that connects inner floor frame supports. The transmission crossmember bolts to this.

Floor Pan Support

- 67-68 Support C7Z-6510813-A

INNER FLOOR FRAME SUPPORT



Supports have sharp bends with good definition. 14 gauge adds strength.

Floor Frame Support, Inner

- 64-68 CP & FB, 4"W x 2 7/8"H x 29"L M121
- 64-68 CV, 4"W x 2 7/8"H x 29"L M121A
- 69-70 CP & FB M121-69
- 71-73 LH M221LH
- 71-73 RH M221RH

CONVERTIBLE INNER FRAME PATCH



This improved part fits LH or RH. Made from high quality 14 gauge steel.

Frame Patch, Convertible Inner

- 64-70 RH or LH, 14 gauge steel M122LR

CONVERTIBLE REINFORCEMENT PAN



Add structural strength to your convertible, seat holes are already drilled.

Reinforcement Pan, Convertible

- 64-68 LH, raw steel M120LH
- 64-68 RH, raw steel M120RH

FRONT FRAME RAIL

The best frame rail available. Gives the original appearance and strength when installed. Original style.

Frame Rail, Front



- 64-67: LH, outer only
MC124LH

- 64-67: RH, outer only
MC124RH



- 64-70: LH, 31" outer only
MC124ALH

- 64-70: RH, 31" outer only
MC124ARH



- 64-70: LH, full frame rail
MC124FLH

- 64-70: RH, full frame rail
MC124FRH

CONVERTIBLE REINFORCEMENT PLATE



Bolts to lower pans for added strength.

Reinforcement Plate, Convertible

- 64-68 C5Z-7610962

SEAT BELT ANCHOR PLATE



Now you can replace this original part, which is commonly striped out, with a nice reproduction. Must be

welded to floor pan.

Seat Belt Anchor Plate

- 64-73 Weld in place C5Z-61216

SEAT PLATFORM



Replace and re-enforce the mounting area for the seat.

Seat Platform

- 64-68 CP & FB, LH M132LH
- 64-68 CP & FB, RH M132RH
- 69-70 FB, LH M232LH
- 69-70 FB, RH M232RH

CONVERTIBLE SEAT PLATFORM



To repair that rusty or damaged seat platform.

Seat Platform, Convertible

- 64-70 CV M132CV

SHOCK TOWER & APRON ASSEMBLY



A beautiful repair panel, this includes a complete front frame rail, full front and rear inner front fender aprons and complete

inner and outer shock tower. This piece will replace it all. Must be shipped by truck only.

Shock Tower And Apron Assembly

- 64-66 RH C5Z-16054-RHC
- 64-66 LH C5Z-16055-LHC
- 67-68 RH C7Z-16054-RHC
- 67-68 LH C7Z-16055-LHC
- 69-70 RH C9Z-16054-RHC
- 69-70 LH C9Z-16055-LHC

OUTER SHOCK TOWER



Stamped from 16 gauge steel with stronger 16 gauge one piece inner support welded in place.

Shock Tower, Outer

- 64-66 LH M125LH
- 64-66 RH M125RH
- 67-70 LH M225LH
- 67-70 RH M225RH

SHOCK TOWER CAP



These precision crafted, steel stamped reproductions are perfect replacements for broken, bent or ugly originals. Each cap contains both front

shock nuts pressed into place.

Shock Tower Cap

64-66 Black	C5ZZ-18A017-A
64-66 Chrome	C5ZZ-18A017-C
67-70 Black	C7ZZ-18A017-A
67-70 Chrome	C7ZZ-18A017-C
71-73 Black	D1ZZ-18A017-B

INNER SHOCK TOWER PATCH



To replace the damaged or rusted lower shock tower.

Shock Tower Patch, Inner

64-66	M129
-------------	------

SHOCK TOWER WITH BRACKET



A welcomed reproduction part to replace those damaged towers. Painted black.

Shock Tower With Bracket

65-66 RH	C5ZZ-6503438-C
65-66 LH	C5ZZ-6503439-C
67-68 RH	C7ZZ-6503438-C
67-68 LH	C7ZZ-6503439-C
69-70 RH	C9ZZ-6503438-C
69-70 LH	C9ZZ-6503439-C

STRUT ROD BRACKET



High quality steel, painted black.

Strut Rod Bracket

64-66 LH	C5ZZ-6503487-L
64-66 RH	C5ZZ-6503487-R
67-70 LH, lower	C7ZZ-6503487-L
67-70 RH, lower	C7ZZ-6503487-R

OVER AXLE FRAME RAIL



Curved part of frame over the differential, right or left hand.

Frame Rail, Over Axle

64-69 24" long, RH or LH.	MM102
--------------------------------	-------

REAR FRAME RAIL WITH TORQUE BOX



Made in the USA, these frame rails consists of a 3 sections welded together and reinforced

with internal gussets at joints for extra strength, these also include torque box attached to save labor, and are shipped in raw steel.

Frame Rail with Torque Box, Rear

64-68 CV, RH	MM102-A-103BRH
64-68 CV, LH	MM102-A-103BLH
64-68 CP & FB, RH	MM102-A-103RH
64-68 CP & FB, LH	MM102-A-103LH
69-70 CV, RH	MM302-A-103CR
69-70 CV, LH	MM302-A-103CL
69-70 CP & FB, RH	MM302-A-103HR
69-70 CP & FB, LH	MM302-A-103HL

FULL REAR FRAME RAIL



We also offer a new version that is frame rail stamped as one complete piece like

originals. Painted black. Torque Box included, but not attached.

Frame Rail, Full Rear

65-68 CP & FB, RH, concours	C5ZZ-6510124NTB
65-68 CP & FB, LH, concours	C5ZZ-6510125NTB
65-68 CV, RH, concours	C5ZZ-7610125-KR
65-68 CV, LH, concours	C5ZZ-7610125-KL

REAR FRAME RAIL PATCH



Gives the original appearance and strength when installed. Original style.

Frame Rail Patch, Rear

64-70 4"W x 5"H x 29-1/2"L, LH	M103ALH
64-70 4"W x 5"H x 29-1/2"L, RH	M103ARH

TORQUE BOX



To allow for complete clutch adjustment the left side has full original impression. High quality 14 gauge steel.

Torque Box

64-68 CV, LH	M114LH
64-68 CV, RH	M114RH
67-70 CP/FB, LH	M114ALH
67-70 CP/FB, RH	M114ARH

UPPER REAR TORQUE BOX



To replace or patch the upper torque box.

Torque Box, Upper Rear

64-68 LH	M130LH
64-68 RH	M130RH

REAR TORQUE BOX PATCH



Complete for frame rail over the rear axle. Welded into one piece like original.

Torque Box Patch, Rear

64-70 CV, LH	MM102CLH
64-70 CV, RH	MM102CRH
64-70 CP, LH	MM102LH
64-70 CP, RH	MM102RH

TRANSITION PAN



Original gauge sheet metal is used in the manufacturing of this beautiful part. Made to

exact specifications for a perfect fit. Finished in a smooth semi-gloss black paint. Shock mounts are included.

Transition Pan

64-68 w/ shock mounts	M3649
-----------------------------	-------

FENDERS, DOORS AND FRONT VALANCE

CUSTOM FIBERGLASS BODY KIT



Give you mustang a classic look! Not only do these cars look great, they are the hottest thing out there right now. The manufacturer went to great lengths to make sure this high quality kit was as easy to install as possible. We recommend that this kit be installed by an experienced fiberglass installer. Kit includes 18 parts. Hood, Nose, Headlamp buckets, wheel flares, side skirts, side scoops, tail panel, quarter extensions and deck lid.

Custom Fiberglass Body Kit

67-68	S7MS-E-FGMK
-------------	-------------

CUSTOM FRONT SUPPORT BRACKET



This new restoration part from Scott

Drake will help in building your very own Eleanor. The support brace bolts to factory bumper bracket holes. It serves two purposes by acting as a reinforcement for the lower nose, and as well as providing the mounting location for Eleanor Driving Lights. It is finished in a black textured powder coated surface. Get yours today to help make your dream car a reality.

Custom Front Support Bracket

67-68	S7MS-FSB
-------------	----------

COMPLETE DOOR SHELL



Brand new tooling. Good fit offers an alternative to a used door.

Door Shell, Complete

64-66 RH	C5ZZ-6520124-B
64-66 LH	C5ZZ-6520125-B
67-68 RH	C7ZZ-6520124-B
67-68 LH	C7ZZ-6520125-B
69-70 RH	D0ZZ-6520124-A
69-70 LH	D0ZZ-6520125-A

DOOR SKIN



A good quality reproduction Door Skin. Painted black. Ready to install.

Door Skin

64-66 RH	C5ZZ-6520200-A
64-66 LH	C5ZZ-6520201-A
67-68 RH	C7ZZ-6520200-A
67-68 LH	C7ZZ-6520201-A
69-70 RH	C9ZZ-6520200-A
69-70 LH	C9ZZ-6520201-A

LOWER DOOR SKIN



Repairs lower section of door. Full length 47"L x 8"H.

Door Skin, Lower

64-66 LH	M110LH
64-66 RH	M110RH

FENDER FROM FORD OEM TOOLING



Scott Drake now offers superior quality replacement sheetmetal produced from Ford's original tooling and in most

cases by Ford's original manufacturer. These parts come with an electrostatically applied epoxy base primer for superior adhesion and rust protection. These are by far the best products on the market.

Fender from Ford OEM Tooling

65-66 RH	C5ZZ-16005-A
65-66 LH	C5ZZ-16006-A
67 RH	C7ZZ-16005-A
67 LH	C7ZZ-16006-A
68 RH	C8ZZ-16005-A
68 LH	C8ZZ-16006-A

REPRODUCTION FENDER



Our reproduction fenders offer an inexpensive alternative to purchasing O.E.M. parts, with only a slight loss in fit when

compared with genuine Ford parts. Shipped painted black and deburred.

Fender, Reproduction

64-66 RH	C5ZZ-16005-AR
64-66 LH	C5ZZ-16006-AR
67 RH	C7ZZ-16005-AR
67 LH	C7ZZ-16006-AR
68 RH	C8ZZ-16005-AR
68 LH	C8ZZ-16006-AR
69 RH	C9ZZ-16005-AR
69 LH	C9ZZ-16006-AR
70 RH	D0ZZ-16005-AR
70 LH	D0ZZ-16006-AR
71-72 RH	D1ZZ-16005-AR
71-72 LH	D1ZZ-16006-AR
73 RH	D3ZZ-16005-AR
73 LH	D3ZZ-16006-AR

LOWER REAR CORNER OF FENDER



Comes with rear edge to form door opening.

Fender, Lower Rear Corner Of

64-66 LH	M104LH
64-66 RH	M104RH
67-68 LH	M204LH
67-68 RH	M204RH

FRONT LICENSE BRACKET



Bracket used to mount a front license plate to the valance.

Front License Bracket

69-70	C9ZZ-17A385-B
71-73 Chrome bumper	D1ZZ-17A385-A
71-73 Urethane bumper	D1ZZ-6540522-A

FRONT SPOILER



Vacuum formed impact resistant plastic with textured surface.

Front Spoiler

67-68	C7ZZ-63001A74-A
69	C9ZZ-63001A74-A
70	D0ZZ-63001A74-A
71-73	D1ZZ-63001A74-A

FRONT VALANCE



Our stampings are all carefully tooled to eliminate fit-up problems during installation. We offer the best fitting valances in the business for satisfied customers each time.

Front Valance

64-66 OEM Tooling	C5ZZ-17A939-A
64-66	C5ZZ-17A939-AR
67-68 OEM Tooling	C7ZZ-17A939-A
67-68	C7ZZ-17A939-AR
69	C9ZZ-17A939-AR
70	D0ZZ-17A939-AR
71-72	D1ZZ-17A939-AR
73	D3ZZ-17A939-AR

FIBERGLASS FRONT VALANCE



Front Valance, Fiberglass

64-66 "R" model, use w/ front bumper	S1MS-17A939-RB
67-68 "R" model, use w/ front bumper	S7MS-17A939-R

HEADLIGHT BUCKET ASSEMBLY

Kits contain most mounting hardware. Reproduction unless otherwise noted. Headlight Bucket Assembly



65-66: RH	C5ZZ-13008-CR
65-66: LH	C5ZZ-13008-DR



67-68: RH	C7ZZ-13008-CR
67-68: LH	C7ZZ-13008-DR



69: RH	C9ZZ-16018-R
69: LH	C9ZZ-16019-L



70: RH	D0ZZ-16018-R
70: LH	D0ZZ-16019-L

HEADLIGHT BUCKET HOUSING



Headlight Bucket Housing

65-66 LH	C5ZZ-13100-L
65-66 RH	C5ZZ-13100-R

WE PROUDLY FEATURE AUTHENTIC MUSTANG REPRODUCTIONS FROM SCOTT DRAKE ENTERPRISES!



HEADLIGHT DOOR

Die cast headlamp door which fits on the headlamp assembly. Primered.

Headlight Door



65-66: LH
C5ZZ-13064-A
65-66: RH
C5ZZ-13064-B



67-68
C7ZZ-13064-A



67-68: Chrome
C7ZZ-13064-C



69: Outer
C9ZZ-13064-A



69: Inner
C9ZZ-13064-B/C



70
DOZZ-13064-A/B

INNER STRUCTURE OF FENDER



Inner structure behind the lower rear corner of the fender. Very common to rust.

Inner Structure Of Fender

64-66 LH M104ALH
64-66 RH M104ARH
67-68 LH M204ALH
67-68 RH M204ARH

NOSE BRACKET



Used on Shelby cars. Stamped steel construction, like original. Painted black.

Nose Bracket

68 RH S8MS-17792-A
68 LH S8MS-17793-A

NOSE REINFORCEMENT



Used on Shelby cars. Stamped metal to give fiberglass extra support.

Nose Reinforcement

68 S8MS-8B231-A

PARKING LIGHT RETAINER



Stamped steel and zinc plated to prevent rust. Fits behind parking lamps.

Parking Light Retainer

64-66 RH C5ZZ-13220-C
64-66 LH C5ZZ-13221-C

ROCKER PANEL

Renew the structural strength of your Mustang. Rockers have original radius not sharp bends. Note: Rocker Panels with C5ZZ- part numbers will work on 64-66 cars, but require modifications where rocker meets fender.

Rocker Panel

64-68: CV, inner LH 6"W x 2 5/8" H x 75"L
M112LH
64-68: CV, inner RH 6"W x 2 5/8" H x 75"L
M112RH
69-73: CV, inner LH
M112ALH
69-73: CV, inner RH
M112ARH
65-68: CP & FB, RH, complete
C5ZZ-6510128-A
65-68: CP & FB, LH, complete
C5ZZ-6510129-A
65-68: CV, RH, complete
C5ZZ-7610128-A
65-68: CV, LH, complete
C5ZZ-7610129-A
64-68: Lower front patch, LH
M141LH
64-68: Lower front patch, RH
M141RH

DELUXE SPLASH SHIELD



All new stampings which include fresh rubber, securely attached.

Splash Shield, Deluxe

64-66 Front, right C5ZZ-16102-AR
64-66 Rear, right C5ZZ-16102-BR
64-66 Front, left C5ZZ-16103-AR
64-66 Rear, left C5ZZ-16103-BR
67-68 Front, right C7ZZ-16102-AR
67-68 Rear, right C7ZZ-16102-BR
67-68 Front, left C7ZZ-16103-AR
67-68 Rear, left C7ZZ-16103-BR

STANDARD SPLASH SHIELD



New stampings which need to have our rubber splash shield kit attached prior to use. See the "Rubber & Weatherstripping" category earlier in this catalog.

Splash Shield, Standard

64-66 Front, left C5ZZ-16103-A
64-66 Rear, left C5ZZ-16103-B
65-66 Front, right C5ZZ-16102-A
65-66 Rear, right C5ZZ-16102-B
67-68 Front, right C7ZZ-16102-A
67-68 Rear, right C7ZZ-16102-B
67-68 Front, left C7ZZ-16103-A
67-68 Rear, left C7ZZ-16103-B

REAR SPLASH SHIELD SUPPORT BRACKET



Splash Shield Support Bracket, Rear

67-68 C7ZZ-16256/7-A

STONE DEFLECTOR



Mounts behind the front bumper. Stamped steel, shipped lacquered black for protection.

Stone Deflector

64-66 From OEM tooling C5ZZ-17779-A
64-66 Economy, import C5ZZ-17779-AR
64-66 From new improved tooling C5ZZ-17779-B
67-68 From OEM tooling C7ZZ-17779-A
67-68 Import C7ZZ-17779-AR
69 C9ZZ-17779-AR
70 DOZZ-17779-AR

STONE DEFLECTOR BRACKET



Three piece metal stone guard bracket set. Flat black coated like originals.

Stone Deflector Bracket

67-68 C7ZZ-17747-AR

VALANCE TO FRAME BRACKET



Brackets to attach the front valance to the frame.

Valance To Frame Bracket

69-70 C9ZZ-17747-A

HOOD AND ENGINE COMPARTMENT

COWL COVER



Covers the cowl to prevent water and debris from entering and causing unwanted damage

to a hard to replace area. Easy installation.

Cowl Cover

64-66 Cover	ACC-16741-65
67-68 Cover	ACC-16741-67

COWL GRILLE ASSEMBLY



Cowl Grille Assembly

65-66 Assembly	C5ZZ-6502010/28
67-68 Assembly	C7ZZ-6502010/28

LOWER COWL PANEL



Cowl Panel, Lower

67-68	C7ZZ-6502010-A
69-70 Inner, w/ bracket	C9ZZ-6502010-A

UPPER COWL PANEL



Cowl Panel, Upper

67-68	C7ZZ-6502228-A
-------------	----------------

COWL SIDE PANEL



Fits under the cowl and behind the wheelwell

Cowl Side Panel

64-68 LH	M133LH
64-68 RH	M133RH

COWL VENT REPAIR KIT



For the frequently rusted cowl area. Kit includes sleeves, sealant, and instructions. Provides a watertight repair for this trouble area.

Cowl Vent Repair Kit

64-68	C5ZZ-6502010-K
-------------	----------------

COWL VENT REPAIR PANEL



This part commonly needs to be replaced on restoration projects due to rust damage over time.

Cowl Vent Repair Panel

64-68 LH	M136LH
64-68 RH	M136RH

FRONT CROSS MEMBER



Stamped steel construction. Many get damaged due to improper jack lifting or front end collisions.

Front Cross Member

64-66	MM133
67-70	MM233

RADIATOR SUPPORT



Heavy gauge steel stampings for serious front sheet metal repairs. Shipped lacquered black for corrosion protection.

Radiator Support

64-66	C5ZZ-16138-A
67-68	C7ZZ-16138-B
69	C9ZZ-16138-A
70	D0ZZ-16138-A
71-73	D1ZZ-16138-A

BATTERY APRON PLATE



A repair panel to re-enforce the section that gets eaten away around the battery.

Battery Apron Plate

69 RH	C9ZZ-16052-P
-------------	--------------

FENDER APRON BRACKET



Attaches to cowl and back of fender apron.

Fender Apron Bracket

64-66 LH	M127ALH
64-66 RH	M127ARH
67-68 LH	M227ALH
67-68 RH	M227ARH
69-70 LH	M327ALH
69-70 RH	M327ARH

FRONT FENDER APRON



Good seller, many need replacing due to front end collisions, rust, & battery acid damage.

Fender Apron, Front

64-66 Import, LH	M116LH
64-66 USA, RH	M116RH
67-68 Import, LH	M216LH
67-68 USA, RH	M216RH
67-68 Import, RH	M216RH-T
69-70 Import, RH	C9ZZ-16054-AR
69-70 Import, LH	C9ZZ-16055-AR
71-73 Import, LH	M416LH
71-73 Import, RH	M416RH

REAR FENDER APRON



Hood hinges bolt to these aprons. Made from heavy gauge steel.

Fender Apron, Rear

64-66 LH	M127LH
64-66 RH	M127RH
67-68 LH	M227LH
67-68 RH	M227RH
69-70 LH	M327LH
69-70 RH	M327RH
71-73 LH	M427LH
71-73 RH	M427RH

INNER FRONT FENDER BRACKET



Connects the fender to the front inner panel.

Fender Bracket, Inner Front

64-66 LH	M123LH
64-66 RH	M123RH

FULL FIREWALL



A nice reproduction stamping. ready to weld in place. Painted satin black.

Firewall, Full

64-66 All	M134
67-68 FB & CP	C7ZZ-6501605-FW

PARTIAL FIREWALL OUTER



Firewall Outer, Partial

64-68 LH	M134LH
64-68 RH	M134RH

WE PROUDLY FEATURE AUTHENTIC MUSTANG REPRODUCTIONS FROM SCOTT DRAKE ENTERPRISES!



FIBERGLASS SHELBY HOOD

Hood, Fiberglass Shelby



65-66: w/ metal frame
S1MS-16612-MF



67: Shelby orig. fit, Note: will not fit
67-68 Mustangs
S7MS-16612-L
67-68: w/ metal frame to fit stock
Mustangs
S7MS-16612-SH

FORD OEM TOOLING HOOD

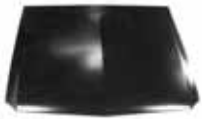

Superior quality replacement sheetmetal hood produced from Ford's original tooling and in most cases by Ford's

original manufacturer. These parts come with an electrostatically applied epoxy base primer for superior adhesion and rust protection.

Hood, Ford OEM Tooling

64 w/ sharp edgesC4ZZ-16612-B
65-66C5ZZ-16612-B
67-68 w/out turn signal reliefs ..C7ZZ-16612-C
67-68 w/ turn-signal reliefsC7ZZ-16612-D
69-70 Underside correct for 1970 D0ZZ-16612-A

REPRODUCTION HOOD

Our reproduction hoods are formed and assembled overseas for an inexpensive alternative to O.E.M. parts. Shipped lacquered black for corrosion protection.

Hood, Reproduction

65-66 New tooling! Very good fit ..C5ZZ-16612-BR
67-68 w/out turn signal reliefs C7ZZ-16612-CR
67-68 w/ turn signal reliefsC7ZZ-16612-DR
69-70 Underside correct for 69 .C9ZZ-16612-AR
71-73 w/ 2 scoop cut outs D1ZZ-16612-AR

HOOD SCOOP

A nice reproduction.
Hood Scoop



65-66: Shelby, bond on
S1MS-16025



67-68: Eleanor, bond on
S7MS-16025-E



69-70: Bolt on
C9ZZ-16C630-A



71-73
D1ZZ-16C630/1

HOOD SCOOP GRILLE

Grille that fits across the front of the hood scoop to keep out birds and low flying aircraft
Hood Scoop Grille



69-70
C9ZZ-16A624-C
71-73
D1ZZ-16A624/5-A

HOOD TURN SIGNAL INSERT



Now made by Scott Drake. Quality die cast with exact fit and detail.

We made the grill support straps stronger to prevent breakage to this commonly broken area. Includes grill and studs. Ready to paint.

Hood Turn Signal Insert

67-68 RHC7ZZ-16720-A
67-68 LHC7ZZ-16721-A

HOOD TURN SIGNAL INSERT GRILLE



Now made by Scott Drake. Exact detail. Ready to paint

Hood Turn Signal Insert Grille

67-68C7ZZ-16870-A

HOOD HINGE



Heavy duty steel stampings. Painted black

Hood Hinge

64-66 RH C30Z-16796-AR
64-66 LH C30Z-16797-AR
67-70 RHC7ZZ-16796-AR
67-70 LHC7ZZ-16797-AR

HOOD HINGE MOUNTING KIT



Hood Hinge Mounting Kit

64-68 359662-SMK

HOOD HINGE SPRING



Standard equipment springs for that finishing touch on the hinges. Not for Shelby cars with fiberglass hoods.

Hood Hinge Spring

64-70 C30Z-16789-AR

HOOD LATCH

Complete latch now available. With or without top plate. Painted black.
Hood Latch



64-65: w/ top plate
CSZZ-16700



65: w/ support brace
CSZZ-16700-K



66: w/ support plate
C6ZZ-16700



67-68: Bolts on hood
C7ZZ-16700-C



69-70
C9ZZ-16700-A

HOOD LATCH SUPPORT



A nice Reproduction of the Hood Latch Support. Painted black.

Hood Latch Support

67-68C7ZZ-16700-A
69-70C9ZZ-16700-R

HOOD SAFETY LATCH



Painted black.

Hood Safety Latch

64-66 C4DZ-16918-B

HOOD LATCH PIN



Hood Latch Pin. Nut and Washer Included.

Hood Latch Pin

64-66CSZZ-16929-A

HOOD LATCH SUPPORT BRACE



This brace is used to reinforce the hood latch where it fastens to the core support on 1965 and 1966 Mustangs.

Hood Latch Support Brace

64-66CSZZ-16747-A

HOOD PROP ROD



This prop rod is made from high quality 304 stainless steel rod and polished to really catch the eye. Stainless steel washers and spring

also included. Total rod length is 35 inches but can be cut to length if desired.

Hood Prop Rod

64-68	Stainless	C5Z-16826-S
65	Shelby	S1MS-16826

SHAKER HOOD TRIM RING



Pressure die cast construction. Hides raw edge of hood. Includes two mounting brackets.

Shaker Hood Trim Ring

69-70	C9Z-16958-A
-------	-------	-------------

QUARTER PANEL, TOP & REAR

DRAIN HOLE COVER



Like original. The screws are included for these galvanized and die stamped drain hole covers.

Drain Hole Cover

64-73	MM-111
-------	-------	--------

LOWER PANEL IN FRONT OF REAR WHEEL



Lower portion of wheel opening with bottom and front edge included

Lower Panel In Front Of Rear Wheel

64-66	LH	M102ALH
64-66	RH	M102ARH

PANEL BEHIND REAR WINDOW



This commonly rusted part fits between the rear window and the trunk lid. Finished in semi-gloss epoxy primer.

Panel Behind Rear Window

64-66	CV	M128
64-66	CP	M128-CP
67-68	CP	M228-CP

FASTBACK TRUNK LID FILL PANEL



This commonly rusted part fits between the rear window and the trunk lid. Finished in semi-gloss primer epoxy.

Trunk Lid Fill Panel, Fastback

65-66	C5Z-6340310-A
67-68	M3647
69-70	M-328-FB

QUARTER PANEL ASSEMBLY



These reproduction quarter panels offer an affordable replacement for this most complicated

of body panels. Shipped lacquered black for corrosion protection prior to installation.

Quarter Panel Assembly

64-66	CP, RH	C5Z-6527846-BR
64-66	CP, LH	C5Z-6527847-BR
64-66	CV, RH	C5Z-7627846-AR
64-66	CV, LH	C5Z-7627847-AR
65-66	FB, 1 piece RH	C5Z-6327846-C
65-66	FB, 1 piece LH	C5Z-6327847-C
67	FB, 1 piece RH	C7Z-6327846-CR
67	FB, 1 piece LH	C7Z-6327847-CR
67	CP, RH, w/ louver holes	C7Z-6527846-A
67	CP, LH, w/ louver holes	C7Z-6527847-A
67	CV, RH, w/ louver holes	C7Z-7627846-C
67	CV, LH, w/ louver holes	C7Z-7627847-C
68	FB, RH	C8Z-6327846-A
68	FB, LH	C8Z-6327847-A
68	CP, RH	C8Z-6527846-A
68	CP, LH	C8Z-6527847-A
69	FB, RH	C9Z-6327846-CR
69	FB, LH	C9Z-6327847-CR
70	FB, RH	D0Z-6327846-A
70	FB, LH	D0Z-6327847-A

QUARTER PANEL SKIN



Our replacement skins eliminate much of the demolition work that accompanies complete quarter panel replacement.

Quarter Panel Skin

65-66	RH	C5Z-6527846-S
65-66	LH	C5Z-6527847-S
67-68	RH, w/out holes	C7Z-6527840-S
67-68	LH, w/out holes	C7Z-6527841-S
68	CP & CV, RH, w/ indent	C8Z-6527840-S
68	CP & CV, LH, w/ indent	C8Z-6527841-S
69	CP & CV, RH	C9Z-6527840-S
69	CP & CV, LH	C9Z-6527841-S
69-70	FB, RH, w/out any holes	C9Z-6327840-S
69-70	FB, LH, w/out any holes	C9Z-6327841-S
70	CV, RH (Modify for CP)	D0Z-6527840-S
70	CV, LH (Modify for CP)	D0Z-6527841-S
71-73	CP & CV, RH	D1Z-6527846-S
71-73	CP & CV, LH	D1Z-6527847-S
73	FB, RH	D3Z-6327846-S
73	FB, LH	D3Z-6327847-S

PARTIAL QUARTER PANEL



Longer version of the rear wheel flares. Extends all the way to the door jamb and overlaps 1".

Quarter Panel, Partial

64-66	LH	M101ALH
64-66	RH	M101ARH
67-68	LH	M201ALH
67-68	RH	M201ARH
71-73	LH	M401LH
71-73	RH	M401RH

LOWER REAR QUARTER PANEL



Covers the lower rear section of the quarter panel. Has pressed-in seams on the bottom and has the contour of

the wheel opening. Also has an offset on the top edge for installation.

Quarter Panel, Lower Rear

64-66	LH	M100ALH
64-66	RH	M100ARH
67-68	LH	M200LH
67-68	RH	M200RH
69-70	LH, FB	M300ALH
69-70	RH, FB	M300ARH
69-70	LH, CP/CV	M300LH
69-70	RH, CP/CV	M300RH
71-73	LH	M400LH
71-73	RH	M400RH

REAR WHEEL FLARE



Covers the upper section of the wheel opening. Offset on top edge for easier installation. Overlaps

the lower rear quarter when both are used.

Rear Wheel Flare

69-70	LH	M301LH
69-70	RH	M301RH

UPPER QUARTER VENT LOUVERS



Quarter Vent Louvers, Upper

67-68	C7Z-63280B62-K
-------	-------	----------------

QUARTER PANEL EXTENSION

Quarter Panel Extension
Quarter Panel Extension



64-66: RH
C5ZZ-6527702-A



67-68: FB, RH
C7ZZ-6327702-A



67-68: FB, LH
C7ZZ-6327703-A



67-68: CP & CV, RH
C7ZZ-6527702-A



67-68: CP & CV, LH
C7ZZ-6527703-A



69: FB, RH
C9ZZ-6328010-A



69: FB, LH
C9ZZ-6328011-A



70: FB, RH
D0ZZ-6328010-A

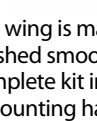

70: FB, LH
D0ZZ-6328011-A

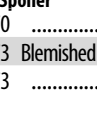

71-72: FB, RH
D1ZZ-6327702-A



71-72: FB, LH
D1ZZ-6327703-A



71-72: CP, RH
D1ZZ-6527702-A



71-72: CP, LH
D1ZZ-6527703-A

REAR SPOILER



This wing is made of strong fiberglass. Finished smooth with dull Black paint. Complete kit includes Spoiler, pedestals, pads & mounting hardware.

Rear Spoiler

69-70 C9ZZ-6344210-K
71-73 Blemished D1ZZ-6344210-BK
71-73 D1ZZ-6344210-K

REAR SPOILER MOUNTING BRACKET



Brackets used to mount the rear spoiler to the deck lid.

Rear Spoiler Mounting Bracket

69-70 C9ZZ-6344220-B

REAR SPOILER MOUNTING GASKET



Now made by Scott Drake. Our gaskets are made of high quality EPDM rubber to provide years of service. Not just a flat

piece of rubber. These pads are formed to fit the slope of the trunk lid. Sold in matching pairs

Rear Spoiler Mounting Gasket

69-73 C9ZZ-6344228/9A

REAR SPOILER MOUNTING HARDWARE KIT



The bases are made from our own tooling with high quality zinc. Our kit also features stainless steel and zinc plated hardware for

years of service. The pads are a Scott Drake exclusive and made of high quality EPDM rubber. Also available for 1971-73 applications.

Rear Spoiler Mounting Hardware Kit

69-70 C9ZZ-6344210-HD
71-73 D1ZZ-6344210-HD

REAR WINDOW LOUVER BOTTOM

LATCH



These are very nice reproductions. Sold in pairs.

Rear Window Louver Bottom Latch

69-70 C9ZZ-6344268-L

REAR WINDOW LOUVER KIT



Complete kit includes louvers, hinges, latches, gaskets and pads.

Rear Window Louver Kit

69-70 C9ZZ-6344268-K

REAR WINDOW LOUVER PAD



Gaskets or pads to protect the paint when installing the rear window louvers.

Rear Window Louver Pad

69-70 6 pieces C9ZZ-6344268

REAR WINDOW LOUVER SEAL



Seals and insulates the rear window louvers to the car.

Rear Window Louver Seal

69-70 C9ZZ-6344268-S

REAR WINDOW LOUVER UPPER HINGES



Hinges to attach the rear louvers and allow them to be raised for cleaning. Polished chrome finish.

Rear Window Louver Upper Hinges

69-70 C9ZZ-6344268-H

ROOF BRACE FRONT



Front support brace for the roof on coupes and fastbacks

Roof Brace Front

65-68 Front C5ZZ-6552103-A

ROOF BRACE REAR



Support brace for the rear of the roof

Roof brace Rear

67-68 FB C7ZZ-6552104-A

FASTBACK ROOF PANEL



Complete Fastback roof panels. Includes outer frame work underneath.

Roof Panel, Fastback

65-66 C5ZZ-6350202-A
67-68 C7ZZ-6350202-A
69-70 C9ZZ-6350202-A

SHELBY SIDE SCOOP



A quality reproduction of the Shelby Side Scoops. Ready to fit and paint.

Side Scoop, Shelby

65-66 S1MS-6529076/7

TAIL LIGHT HONEYCOMB PANEL



All new tooling, made exclusively for Scott Drake. High quality plastic injection part made from ABS plastic. For molding please see

molding section.

Tail Light Honeycomb Panel

70	D0ZZ-63423B70
71-73	D1ZZ-63423B70

TAIL LIGHT HONEYCOMB PANEL MOLDING CLIPS



These 12 special retaining clips are used to mount the Tail Lamp Panel Moldings on all 70-73 Mach 1's. Retaining

nuts are sold separately (# 382146-SMK).

Tail Light Honeycomb Panel Molding Clips

70-73	D0GY-65291B80-A
-------	-------	-----------------

TAIL LIGHT PANEL



Carefully formed to facilitate a painless replacement, these panels offer an affordable repair for damaged originals.

Tail Light Panel

64-66	OEM tooling	C6ZZ-6540324-A
64-66	USA made	C6ZZ-6540324-AR
64-66	Import	C6ZZ-6540324-AT
67-68	C7ZZ-6540324-AR
69	C9ZZ-6540324-AR
70	D0ZZ-6540324-BR
71-73	D1ZZ-6540324-AR

TAIL LIGHT PANEL WITH CORNER DRIP RAILS



Tail Light Panel With Corner Drip Rails

67-68	CP & CV	C7ZZ-6540324-K
-------	---------	-------	----------------

FASTBACK TAIL LIGHT PANEL BRACKET



Panel to secure tail light panel to quarter panel.

Tail Light Panel Bracket, Fastback

69-70	FB, RH	C9ZZ-6328058-A
69-70	FB, LH	C9ZZ-6328059-A

TAIL LIGHT PANEL BRACKET & BRACE



Must be welded in to place. Painted black to resist corrosion.

Tail Light Panel Bracket And Brace

64-66	CP & FB	C5ZZ-6543236-A
64-66	CV	C5ZZ-7643235-A
67-68	C7ZZ-6543236-A
69	C9ZZ-6543236-A

REAR VALANCE



These stampings are painted black for corrosion protection. Aftermarket quality parts.

Rear Valance

64-66	No holes	C5ZZ-6540544-AR
64-66	w/ backup light holes	C5ZZ-6540544-BR
65-66	GT	C5ZZ-6540544-CR
65-66	GT w/ backup light holes	C5ZZ-6540544-DR
67-68	C7ZZ-6540544-CR
67-68	GT	C7ZZ-6540544-DR
69-70	C9ZZ-6540544-AR
69-70	GT / Mach 1	C9ZZ-6540544-BR
71-73	D1ZZ-6540544-AR
71-73	Mach 1	D1ZZ-6540544-BR

WHEELHOUSE AND TRUNK

REAR CROSS MEMBER



This brace is often damaged when rearended. Attaches to tail light panel. Gas tank rests on lip.

Rear Cross Member

64-70	Cross Member	C5ZZ-7610780-BR
-------	--------------	-------	-----------------

CONVERTIBLE TRUNK BRACE



For best results when replacing the crossmember, it is best to replace these pieces as well.

Trunk Brace, Convertible

64-70	Center piece only	M135A
64-70	LH only	M135ALC
64-70	RH only	M135ARC

TRUNK BUMPER BRACE



Gives added strength to the trunk floor.

Trunk Bumper Brace

64-66	LH	MM134BL
64-66	RH	MM134BR
67-68	RH or LH	MM634LR
69-70	RH or LH	MM667LH

TRUNK DIVIDER & PACKAGE SHELF

Replacement sheetmetal for behind rear seat. Original package tray with upgraded steel rear seat divider for coupes.

Trunk Divider and Package shelf



65-68:	CP	C5ZZ-6562118-A
--------	----	-------	----------------



67-68:	FB	C7ZZ-6346610-A
--------	----	-------	----------------

TRUNK FLOOR

Trunk Floor



64-70:	RH	C5ZZ-6511218-A
64-70:	LH	C5ZZ-6511219-A

64-70: RH, concours

C5ZZ-6511218-C

64-70: LH, concours

C5ZZ-6511219-C



71-73:	54" W X 38" L, complete	M438
--------	-------------------------	-------	------

COMPLETE TRUNK FLOOR



These are quality, steel replacements. These are complete trunk floors. Includes drop offs.

Trunk Floor, Complete

65-66	Complete	C5ZZ-6511215-A
67-68	Complete	C7ZZ-6511215-A
69-70	Complete	C9ZZ-6511218/9

TRUNK FLOOR DROP OFF



This drop off meets the bottom section of the quarter panel. Overlaps the trunk floor 1". This is included when buying a trunk floor. MADE IN THE USA. 1969 - 1970 requires trimming.

Trunk Floor Drop Off

64-70	LH, 21" W x 9" L	M109LH
64-70	RH, 21" W x 9" L	M109RH
71-73	LH, 20 1/4" W x 9" L	M409LH
71-73	RH, 20 1/4" W x 9" L	M409RH

TRUNK LID



Good quality import Trunk Lid. Ready to paint and install.

Trunk Lid

64-66	CP & CV	C5ZZ-6540110-CR
65-66	FB	C5ZZ-6340110-A
67-68	FB	C7ZZ-6340110-AR
67-68	CP & CV	C7ZZ-6540110-CR
69-70	FB	C9ZZ-6340110-CR

WE PROUDLY FEATURE AUTHENTIC MUSTANG REPRODUCTIONS FROM SCOTT DRAKE ENTERPRISES!



TRUNK LID & QUARTER EXTENSIONS



Trunk lid and quarter panel extensions for Shelby and California Special. Reproduced just like original.

Trunk Lid and Quarter Extensions

67-68	Shelby CV & California Special	C8ZX-6540110-K
67-68	FB	S7MS-6340110-K

TRUNK LID HINGE



Now you can replace those bent, and or rusted trunk hinges and get the original fit and alignment. Sold as a pair.

Trunk Lid Hinge

67-68	FB	C7ZZ-6342700/1A
69-70	FB	C9ZZ-6342700/1A

TRUNK LID PROP ROD



Our steel prop rod is zinc plated for years of service. We include the storage clip and the retaining clip for a quick and complete

installation. A must when using a rear spoiler.

Trunk Lid Prop Rod

69-70	C9ZZ-6344206
-------	-------	--------------

TRUNK LID STRIKER



Made as original, trunk lid strikers.

Trunk Lid Striker

67-68	C7ZZ-6243252
69-70	C9ZZ-6243252

TRUNK PANEL



Goes between the fuel tank and the rear seat in the trunk area.

Trunk Panel

64-68	M135TP
-------	-------	--------

TRUNK REAR CORNER



Corner pieces for where the quarter panel and taillight meet. Part of the rain gutter. Important

replacement when changing the quarter panels. Coupes and convertibles only. Made in the USA.

Trunk Rear Corner

64-66	CP & CV, LH	M142LH
64-66	CP & CV, RH	M142RH
67-68	CP & CV, LH	M242LH
67-68	CP & CV, RH	M242RH

COMPLETE WHEELHOUSE



Previously available only separately, these complete wheel housings are made of high quality, formed sheet metal. Finished

in black satin paint for corrosion protection. Available in right and left sides. **Must modify**

for convertibles.

Wheelhouse, Complete

65-66	RH	C5ZZ-6527886/94
65-66	LH	C5ZZ-6527887/95
67-68	LH	M3631LH
67-68	RH	M3631RH
69-70	RH	C9ZZ-6527886/94
69-70	LH	C9ZZ-6527887/95

INNER WHEELHOUSE



Fits coupe and fastback, but must be modified for convertible to allow the top to nest properly. The seam needs to be bent over and the inner section flattened slightly

Wheelhouse, Inner

64-70	RH	C5ZZ-6527886-A
64-70	LH	C5ZZ-6527887-A
71-73	LH	D1ZZ-6527887-A
71-73	RH	D1ZZ-6527886-A

OUTER WHEELHOUSE



A quality stamping now available.

Wheelhouse, Outer

64-66	LH	M113LH
64-66	RH	M113RH
67-68	LH	M213LH
67-68	RH	M213RH
69-70	LH	M313LH
69-70	RH	M313RH
71-73	LH	M413LH
71-73	RH	M413RH

PARTIAL OUTER WHEELHOUSE



Wheelhouse, Partial Outer

64-66	LH	M113ALH
64-66	RH	M113ARH

INSULATION & SOUND DEADENER

ACCUOUSTISHIELD™ COMPLETE INSULATION KITS

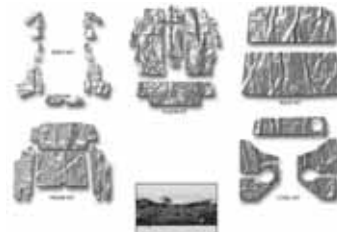

Along with the obvious benefits of automotive insulation, our customers report that their automotive air conditioning is greatly improved because the cool air produced by HVAC systems is captured and maintained inside the vehicle. Audio systems also perform better according to other customers. When the vehicle body is completely insulated, sound way transfer is virtually eliminated and audio system performance and clarity is greatly improved. Our customers report that they can reduce the speaker volume by as much as 50 percent with the installation of AcoustiShield.

Insulation, AccoustiShield Complete Kits

64-68	Coupe	MUST-6468-CAK
64-68	Convertible	MUST-6468-CVAK
64-66	Fastback	MUST-6468-FBAK
67-68	Fastback	MUST-6768-FBAK
69-70	Coupe	MUST-6970-CAK
69-70	Convertible	MUST-6970-CVAK
69-70	Fastback	MUST-6970-FBAK

ACCUOUSTISHIELD™ PARTIAL INSULATION KITS

Insulation, AccoustiShield Partial Kits

64-68	Coupe - Roof	MUST-6468-CRK
64-66	FB - Body Panel	MUST-6468-FBPK
64-68	FB - Roof	MUST-6468-FBRK
64-68	Cowl	MUST-6468-FCCCK
64-68	CP/FB - Floor	MUST-6468-FCCFK
64-68	Trunk Floor	MUST-6468-TFK
69-70	Floor	MUST-6970-FCCFK
64-04	Door Damper	MUST-DSD-2

SOUND DEADENER KIT



All made with die cut precision that makes them easy to install. Drastically reduces

road noise and helps insulate your car from the heat and cold. Includes all pieces originally available for you particular year and bodystyle. Made from E.V.A. Our most complete kit. Kits include the following: L.H. and R.H. Front, Center Trans Hump, Rear Floor, Under Rear Seat, Transition and Trunk sections. 7 piece kit.

Sound Deadener Kit

64-68 CP	UL-CP
64-68 CV	UL-CV
65-68 FB	UL-FB
69-73 CP	UL-CP-L
69-73 CV	UL-CV-L
69-73 FB	UL-FB-L

ACCUOUSTISHIELD™ INSULATED SEAT DIVIDER



Insulated Seat Divider, AccoustiShield

64-68 Coupe	MUST-6468-CSD
-------------------	---------------

ACCUOUSTISHIELD™ INSULATED PACKAGE TRAY



Insulated Package Tray, AccoustiShield

64-68 Coupe	MUST-6468-CPK
-------------------	---------------

HUSHMAT MEGABOND SILENCER INSULATION



Eliminate road noise, vibration and add thermal insulation with premium damping products from Hushmat. Hushmat

offers more than 18 years in automotive OEM experience! HushMat Megabond Silencer is the perfect material to use to reduce heat transfer from your big engine, drive train or exhaust and reduces the high frequency noise caused by road surface variation (tire noise), engine noise, and wind noise passing behind trim panels. Aggressive butyl based adhesive on back for one step peel and stick application. Stick to sheet metal or fiberglass vehicle surface or directly onto aluminum surface of HushMat Ultra vibration damping material for the ultimate COOL & QUIET interior.

HushMat Megabond Silencer Insulation

64-73 Door & headliner - 2 sheets 1/8" thick 23"x35" foam	HM-SIL-1003
64-73 Firewall & floor kit - 2 sheets of 1/4" thick 23"x35" foam	HM-SIL-1008

HUSHMAT ULTRA INSULATION



Eliminate road noise, vibration and add thermal insulation with premium damping products from Hushmat. Hushmat

offers more than 18 years in automotive OEM experience! HushMatUltra features a 1/8" thick and 0.53 lb per square foot pressure-sensitive, constrained-layer damping material which has excellent adhesion for many difficult to-bond-to substrates such as oily steel, automotive E-coat, primers, finishes, laminated and chopper-gun fiberglass and many plastics, including polypropylene.

HushMat Ultra Insulation

64-73 Door kit - 10 sheets of silver 12"x12"	HM-2005
64-73 Trunk kit - 10 sheets of 1/2" thick, 12"x23"	HM-3005
64-73 Floor/dash kit - 20 sheets of silver 12"x23"	HM-4005
64-73 Bulk kit - 30 sheets of silver 12"x23"	HM-5005

UNDERHOOD INSULATION



Rarely seen, as most cars with this option had been removed years ago. Helps reduce engine noise.

Insulation, Underhood

69-70	M274
-------------	------

ACCUOUSTISHIELD™ FIREWALL INSULATOR



Firewall Insulators are made for the year make and model of your Mustang using a rubber

firewall insulator bonded to a thin layer of insulation. These are pre-formed for a perfect fit and original appearance. Greatly reduced engine noise and heat.

Firewall Insulator, AccoustiShield

64-66 All	MUST6466-C
67-68 All	MUST6768-C
69-70 w/out AC	MUST6970-C
69-70 Mach 1 w/AC	MUST6970-CMI

FIREWALL INSULATOR



Features a bonded thermal insulation. Mounting kit included. Die cut for a good fit.

Firewall Insulator

64-66	C5ZZ-6501670-A
67-68	C7ZZ-6501670-A
69-70	C9ZZ-6501670-A
71-73	D1ZZ-6501670-A

STEERING

CENTER LINKS

STEERING CENTER LINK



Popular replacement item. Hundreds sold.

Steering Center Link

64-66 6 cyl., manual steering	C5ZZ-3304-EI
64-66 V8, manual steering	C5ZZ-3304-CI
65-66 V8, w/out control valve ...	C5ZZ-3304-DI
67-69 6 & 8 cyl., manual steering	C7ZZ-3304-CI

IDLER AND PITMAN ARMS

IDLER ARM



Forged iron replacement arms. Kits include bushings and hardware. Quality USA brands.

Idler Arm

64-66 6 cyl., manual steering	C3DZ-3352-L
64-66 6 cyl., P/S	C4DZ-3352-B
64-66 V8, manual or P/S	C5ZZ-3352-BR
67-70 P/S 1 pc design.....	C7ZZ-3350-AR
67-70 P/S 2 pc design.....	C7ZZ-3350-AR
67-70 Manual steering	C7ZZ-3350-BR

WE PROUDLY FEATURE AUTHENTIC MUSTANG REPRODUCTIONS FROM SCOTT DRAKE ENTERPRISES!



IDLER ARM BRACKET

Forged construction.



Idler Arm Bracket
64-66 260, 289 C3DZ-3351-A

IDLER ARM BUSHING

These quality replacements are American made. Steel shell and tube. Fits original Ford idler arms only.



Idler Arm Bushing
64-66 P/S C3DZ-3356-AR
64-66 Manual steering C5Z-3356-AR
67-70 P/S, upper C7OZ-3356-AR

PITMAN ARM

Forged arm replaces worn originals very nicely.



Pitman Arm
64-66 V8, P/S C5Z-3590-A

POWER STEERING

CONTROL VALVE TO CYLINDER HOSE

These are the short hoses which connect the control valve to the power cylinder. Both are high pressure with correct fittings.



Control Valve to Cylinder Hose
64-66 Concours, set of 2 C3DZ-3A714/7-AR
67-70 Concours, set of 2 C6OZ-3A714/17-AR

POWER STEERING BALL AND STUD REPAIR KIT

Includes ball and stud kit and all seals necessary to stop leaks and reduce excess play in steering wheel.



Power Steering Ball and Stud Repair Kit
64-70 C2AZ-3A533-A

POWER STEERING CONTROL VALVE



Power Steering Control Valve
64-66 New C5Z-3A730-N
67-70 New C8ZZ-3A730-SS

POWER STEERING CONTROL VALVE

SEAL KIT

Includes all seals, gaskets and "O" rings needed to stop leaks. Makes your control valve perform properly.



Power Steering Control Valve Seal Kit
64-70 C3AZ-3A650-A

POWER STEERING CYLINDER

These brand new steering cylinder are pressure tested. No core is necessary on these.



Power Steering Cylinder
64-66 C3DZ-3A540-B
67-70 C3DZ-3A540-A

POWER STEERING CYLINDER BOOT AND CLAMP

Compression molded rubber grease and corrosion resistant. Special locking metal band that fits around power steering ram boot.



Power Steering Cylinder Boot and Clamp
64-70 C5Z-3A540-B

POWER STEERING CYLINDER BOOT KIT

Our boot kit includes exact OE washers, steel tube spacer and high quality EPDM rubber bushings and boot.



Power Steering Cylinder Boot Kit
64-70 C6OZ-3C651-A

POWER STEERING CYLINDER SEAL KIT

Kit includes all repair parts necessary to refurbish leaking cylinder/piston rod seal area.



Power Steering Cylinder Seal Kit
64-70 C1AZ-3A764-A

POWER STEERING DROP BRACKET

A must when using Tri-Y headers on a power steering car. Lowers power steering for proper clearance when using Tri-Y headers.



Power Steering Drop Bracket
64-70 DBPP-10961-A

PRESSURE POWER STEERING HOSE



A power steering hose just has to fit, and you will find that this hose not only has the correct, pre-bent ends, it has the "step down" size so that it works just like the original.

Power Steering Hose, Pressure
64 200, w/ Ford pump C5DZ-3A719-A
64-65 260, w/ Ford pump C5Z-3A719-A
65-66 289, w/ Ford pump C5Z-3A719-D
64-65 260, 289, w/ Eaton pump C5Z-3A719-E
67 200, 1/4" control valve fitting C7OZ-3A719-A
67 289, 1/4" control valve fitting C7OZ-3A719-C
67-68 289, 302, 5/16" control valve fitting C7OZ-3A719-D
67-70 390, valve end, 5/16" fitting C7Z-3A94-A
67-70 390, 428, pump end C7Z-3A719-B
67-68 200, 250, 5/16" control valve fitting C8OZ-3A719-B
69 302, 351, pump end, w/out cooler C9Z-3A719-A
69 302, pump end, w/ cooler C9Z-3A719-C
70 302, 351, pump end, w/out cooler D0OZ-3A719-E
71-72 302, 351, before 5-1-72 .. D1Z-3A719-C
71-73 302, 351, after 5-1-72 D1Z-3A719-A

RETURN POWER STEERING HOSE



Power Steering Hose, Return
64-66 260, 289 C5DZ-3A713-D
64-66 170, 200 C5Z-3A713-C
67-70 200, 289, 302 C7OZ-3A713-A
67-70 302, 351, 390, 428 C7OZ-3A713-C
71-73 250, 302, 351, w/out air . D1Z-3A713-A

POWER STEERING HOSE BRACKET



Die stamped metal construction. Insulators not included.

Power Steering Hose Bracket
64-66 C5DZ-3A609/1-A
67-68 C7DZ-3A609/1-A

POWER STEERING HOSE INSULATOR



Made from molded rubber that is specially blended to resist hardening and cracking.

Power Steering Hose Insulator
64-66 C2OZ-3A609-A
67-70 C7Z-3A609-A

SHOP WITH CONFIDENCE! WE OFFER SUPERIOR-QUALITY PARTS FOR ALL YOUR MUSTANG RESTORATION NEEDS.

POWER STEERING PUMP CAP



Now available after being gone for years. Features exact details.

w/ Dipstick, Eaton pump

Power Steering Pump Cap

- 64-65 Zinc, w/ dipstick, Eaton pumpC3AZ-3A006-A
- 64-65 Chrome, w/ dipstick, Eaton pumpC3AZ-3A006-C
- 64-66 Zinc, concours, w/out dipstickC5AZ-3A006-B
- 65-66 Chrome, concours, w/out dipstickC5AZ-3A006-BC
- 65-66 Zinc, concours, w/ dipstickC5AZ-3A006-C
- 65-66 Chrome, concours, w/ dipstickC5AZ-3A006-CC

POWER STEERING PUMP DIPSTICK



Excellent reproductions with high level of detail. Both feature the FoMoCo logo.



Power Steering Pump Dipstick

- 67-73 Zinc, concours *C7AZ-3A006-B
- 67-73 Chrome, concours *C7AZ-3A006-C

POWER STEERING PUMP HOUSING



Power steering canister/pump housing for Ford style pump. This canister has the neck angled back to clear the A/C compressor and will fit non A/C cars also. Comes

with a seal and needs to be painted.

Power Steering Pump Housing

- 64-66C5DZ-3A697-C

POWER STEERING ADJUSTER BRACKET



Power Steering Adjuster Bracket

- 67-69 289, 302C7SZ-3A732-A

POWER STEERING PUMP MOUNTING BRACKET



Power Steering Pump Mounting Bracket

- 65-66 289C5AZ-3A732-B

POWER STEERING PUMP SEAL KIT



Provides everything needed to do a pump rebuild.

Power Steering Pump Seal Kit

- 64-65 Eaton pumpC2AZ-3B584-AR
- 65-73 Ford pumpD1AZ-3B584-A

POWER STEERING SOCKET SLEEVE



This bronze/steel sleeve should be replaced to do a proper rebuild on your control valve.

Power Steering Socket Sleeve

- 65-70C1AA-3A754-C

POWER STEERING TO FRAME BUSHING



Improves steering response. Made from polyurethane, these bushings are long lasting and firmer than stock.

Power Steering to Frame Bushing

- 64-66CSZZ-3A344-P
- 67-70C7ZZ-3A344-P

TILT AWAY STEERING VACUUM CANISTER



Mounts to rear passenger side fender apron. Hold vacuum pressure to operate tilt away switch when car is turned off.

Tilt Away Steering Vacuum Canister

- 67-69 1 portC7ZZ-3E547-A
- 67-69 2 portsC7ZZ-3E547-B

RACK AND PINION

MANUAL STEERING ADAPTER

Easily allows power steering cars to be converted over to manual steering.

Manual Steering Adapter



- 64-66
- CSZZ-3304-AD



- 67-70: Conversion
- C7ZZ-3304-AD

RACK AND PINION KIT



Manual steering that feels like power steering. Easy installation that maintains the original suspension.

No welding. No fabrication. **Due to many variations, we recommend contacting us with your specific application to assure the correct kit.** Tilt columns for original steering wheels are available as a special order.

Rack and Pinion Kit

- 64-69 Rack & pinion, stock spindles, stock exhaust manifolds, no tilt column. Modify factory columnCSZZ-3304-RPSM
- 64-69 Rack & pinion, Granada spindles, stock exh. manifolds, w/ paintable tilt column aftermarket wheelCSZZ-3304-RPK
- 64-69 SB, w/ headers, no tilt column. Modify factory columnCSZZ-3304-RPSH
- 64-69 SB, w/ headers, w/ paintable tilt column aftermarket wheel ..CSZZ-3304-RPSHK

STEERING COLUMNS

LOWER STEERING COLUMN COVER



A very nice reproduction of a commonly broken part.

Lower Steering Column Cover

- 69C9ZZ-6504459-BK
- 70D0ZZ-6504459-BK

TILT STEERING COLUMN



Available in paintable steel or polished stainless steel. Requires mounting kit. Will fit 1970 cars but relocation of ignition switch is required. These fit original

steering boxes only. Modifications required..

Steering Column, Tilt

- 65-66 For aftermarket wheel ...CSZZ-3514-AFT
- 65-66 For aftermarket wheel, stainlessCSZZ-3514-AFT-S
- 65-66 For orig. wheelCSZZ-3514-OEM
- 67-69 For aftermarket wheel ...C7ZZ-3514-AFT
- 67-69 For aftermarket wheel, stainlessC7ZZ-3514-AFT-S
- 67-69 For orig. wheelC7ZZ-3514-OEM

STEERING COLUMN MOUNT KIT



This kit includes all components to install a Flaming River™ tilt column.

Steering Column Mount Kit

- 65-67CSZZ-3514-MK
- 67-70C7ZZ-3514-MK

WE PROUDLY FEATURE AUTHENTIC MUSTANG REPRODUCTIONS FROM SCOTT DRAKE ENTERPRISES!



STEERING COLUMN TO FIREWALL SEAL



These high quality parts assure the restorer of a water-tight seal where the steering column passes through the firewall.

- Steering Column to Firewall Seal**
 64-66 C5ZZ-3513
 67-68 C7ZZ-3513
 71-73 D1ZZ-3513

STEERING COLUMN TO FLOOR GROMMET



Molded rubber. Mounts on steering column over carpet.

- Steering Column to Floor Grommet**
 65-67 B5S-3512

STEERING COLUMN TO GEAR BOX INSULATOR



- Steering Column to Gear Box Insulator**
 64-67 C60Z-3564

STEERING SHAFT SPRING



This is the spring that goes over the column and inside the collar to provide spring tension for the horn ring.

- Steering Shaft Spring**
 64-67 C3DZ-3520-A

STEERING COUPLERS

STEERING COUPLER



This steering coupler, commonly referred to as a "rag joint", connects the steering shaft to the input shaft on the steering box.

- Steering Coupler**
 67-70 Rubber C70Z-3A52S-R
 67-73 Polyurethane C70Z-3A52S-P

STEERING GEAR BOXES

NEW GEAR BOX



These all new boxes feature a improved needle bearing design for smoother operation. They are a direct bolt in, no modifications

required. Early 67 have 1" sector shaft. Late 67 Ford switched to 1 1/8" sector shaft.

- Gear Box, New**
 64-67 19:1 ratio, manual steering, long shaft ... C5ZZ-3548-M
 64-67 16:1 ratio, P/S, long shaft .. C5ZZ-3548-P
 67 19:1 ratio, manual steering, 1" sector w/ short 6" shaft C7ZZ-3548-M
 67 16:1 ratio, short shaft 1" ... C7ZZ-3548-P
 68-70 16:1 ratio, short shaft 1 1/8" C8ZZ-3548-P

REBUILT GEAR BOX

- Gear Box, Rebuilt**
 64-67 19:1 ratio, manual steering, long shaft ... C5ZZ-3548-M-R
 64-67 16:1 ratio, P/S, long shaft C5ZZ-3548-P-R

GEAR BOX COVER SEAL



A leak coming from the steering box can sometimes be traced to the gasket at the steering box cover.

- Gear Box Cover Seal**
 64-70 C3DZ-3581-A

STEERING BOX REBUILD KIT



This steering box rebuild kit can tighten up that loose, drifting feeling.

- Steering Box Rebuild Kit**
 64-67 1" C5ZZ-3548-RK
 67-70 1 1/8" C7ZZ-3548-RK

STEERING WHEEL HORNS

HORN BUTTON RUBBER SPRING PAD



This is the oe rubber pad that is typically smashed in the horn button.

- Horn Button Rubber Spring Pad**
 64-66 CODZ-13A813-A

HORN BUTTON SPRING



Wire spring used with horn ring. Painted.

- Horn Button Spring**
 65-69 CODZ-13A807-B

HORN CONTACT INSULATOR



Replace that broken insulator with this new part.

- Horn Contact Insulator**
 67 Excluding wood wheels C7AZ-13A903-B

HORN CONTACT SPRING



- Horn Contact Spring**
 64 orig. style C20Z-13A821-A

HORN LENS INSULATOR



This foam pad goes between the lens and body of the center cap on the deluxe steering wheel.

- Horn Lens Insulator**
 65-66 dlx. C5ZZ-13A816-A

RIM BLOW HORN PAD



The center pad that covers the spokes of the steering wheel.

- Horn Pad, Rim Blow**
 70-73 Black D0ZZ-3623-A

HORN PANEL BEZEL



Plastic injection and chrome plated. Fits in center of steering wheel, holds vinyl pad and buttons.

- Horn Panel Bezel**
 68-69 C8ZZ-3D572-AR

HORN PANEL BEZEL BUTTON



Chromed Plastic buttons with textured black centers. Set of 6. See emblem for center medallion.

Horn Panel Bezel Button

68-69 Set of 6 C8Z-3600-AR

HORN PANEL PAD

Vinyl pad available in black only.

Horn Panel Pad



68-69: Black
C8AZ-3629-A



70-73: Black, std.
D0ZZ-13915



70-73: Black, dlx.
D1ZZ-13915

HORN RING BUTTON

* Excellent concours reproduction. Diecast construction features acrylic plastic center emblem, chrome plated main assembly and painted recesses.

Horn Ring Button



64: std., generator, concours, 3 spoke*
C5ZZ-13A805-C



65-66: std., alternator, concours, 3 spoke*
C5ZZ-13A805-B



65-67: dlx., for wood wheel, no emblem, 3 spoke
C7OZ-13A805-ER



67: std., no emblem, 3 spoke
C7ZZ-13A805-A



68-69: std., no emblem, 2 spoke
C9AZ-13A805-B

HORN RING CONTACT KIT



Exact reproduction horn ring contact components for the standard horn button.

Horn Ring Contact Kit

65-66 C5ZZ-13A821
67 C7AZ-13A821
68-69 C8AZ-13A821

HORN RING CENTER PAD



Soft padded urethane. Not painted but molded urethane so color will not wear off. Features

our chrome trim ring and center emblem.

Horn Ring Center Pad

67 Aqua* C7ZZ-3623-AQ
67 Black* C7ZZ-3623-BK
67 Blue* C7ZZ-3623-BL
67 Ivy Gold* C7ZZ-3623-IG
67 Parchment* C7ZZ-3623-PR
67 Red* C7ZZ-3623-RD
67 Saddle* C7ZZ-3623-SA

HORN RING CONTACT KIT



Exact reproduction horn ring contact components for the standard horn button.

Horn Ring Contact Kit

65-66 C5ZZ-13A821
67 C7AZ-13A821
68-69 C8AZ-13A821

HORN RING RETAINER



Correct original design. Plastic injected nylon is more wear and crack resistant.

Horn Ring Retainer

64 Generator C2DZ-13A809-A
65-66 Alternator D1TZ-13A809-A

HORN SWITCH



Fits deluxe or standard 2 spoke wheel.

Horn Switch

70-73 D2AZ-13875

RIM BLOW HORN SWITCH



The switch that goes inside the rim of the steering wheel to actuate the horn.

Horn Switch, Rim Blow

69 C9AZ-13A875-C
70-73 D1AZ-13A875-A

HORN SWITCH TRIM PLATE



Wood grain plate for deluxe 2 spoke wheel.

Horn Switch Trim Plate

71-73 Wood grain D1ZZ-13932

STEERING WHEEL, GRANT

GRANT HORN BUTTON



Optional button to customize your Grant steering wheel. Only fits 1170 wood wheel.

Grant Horn Button

64-73 Horn button* 5668
64-73 Grant 966 wheel 5847
64-73 Chrome* 5875
65-73 Ford blue* 5665

GRANT HUB KIT



These kits are fully assembled for easy installation and are available in either a highly polished mirror finish or anodized in deep, black luster finish.

Grant Hub Kit

68-73 Black 5249
68-73 Highly polished 5249-1

GRANT REAL MAHOGANY STEERING WHEEL

Quality 14.5" steering wheels made from genuine mahogany. Includes center emblem on horn center. Either hub kit or adapter required.

Grant Steering Wheel



64-73: with rivets
1175



65-73: without rivets
1170

GRANT STEERING WHEEL

* Aluminum frame aftermarket steering wheel with Mustang center emblem on horn center. Adapter Required.

Grant Steering Wheel



64-73: Wood, 13 1/2", no emblem
963



64-73: Wood, 15" *
966



65-73: Black foam*
968

GRANT STEERING WHEEL ADAPTER



Mounting and contact adapter required for each Grant wheel.

Grant Steering Wheel Adapter	
64	3285
65-67	3294
68-73	3249

GRANT TILT COLUMN ADAPTER



Special adapter required to run Grant™ steering wheels on a Flaming River™ tilt

column. Replaces 3294 & 3249 adapters. Will not work with Lecarra™ steering wheels

Grant Tilt Column Adapter	
65-70	CSZZ-3514-GMA

STEERING WHEEL, LECARRA

LECARRA COBRA EMBLEM



This fits the adapter to change center emblem to Cobra.

Lecarra Cobra Emblem	
65-73 \$	S1MS-3649-C

LECARRA COLUMN ADAPTER



Hub to adapt the Lecarra steering wheels. Now with adjustable feature.

Lecarra Column Adapter	
64-66 Billet	S1MS-3511-P
67-73 Billet	S7MS-3511-P

LECARRA HORN BUTTON



Horn button for LecARRA steering wheel, has two wire connector.

Lecarra Horn Button	
65-73 Double connector	S1MS-3623-A

LECARRA STEERING WHEEL

A beautiful wheel and the perfect choice for a Shelby look a like. These wheels are handcrafted with pride. Requires adapter and horn button

Lecarra Steering Wheel	
 65-73: Genuine wood, 15" S1MS-3600-WG	

STEERING WHEELS

STEERING WHEEL HUB EMBLEM



The most authentic and best looking emblems available.

Emblem, Steering Wheel Hub



67: Running horse*
C7ZZ-3649-A



68: Running horse*
C8ZZ-3649-AR



68: Shelby Cobra[®]
S8MS-3649-A



69-70: Shelby Cobra[®]
C9MS-3649-A



69-73: For use on 2-spoke wheel
C9ZZ-3649-S

STEERING WHEEL HUB TRIM



This is the chrome trim ring that goes on the steering wheel hub. 4 3/8" diameter. Installation note: warm up foam hub with

hot air, apply solution of dish washing soap & water, then press firmly.

Hub Trim, Steering Wheel	
67	C7ZZ-3656-A

STEERING WHEEL HUB TRIM & EMBLEM



Great kit for complete steering wheel restoration.

Hub Trim & Emblem, Steering Wheel	
67	C7ZZ-3649/56-K

STANDARD STEERING WHEEL



Molded in hard plastic, wheel feature nice details, a new wheels really brings the interior together. Look for new lower prices on steering wheels summer 2008.

Steering Wheel, Standard

64 Black, generator	C4ZZ-3600-BK
64 Blue, generator	C4ZZ-3600-BL
64 Palamino, generator	C4ZZ-3600-PA
64 Red, generator	C4ZZ-3600-RD
64 White, generator	C4ZZ-3600-WT
65 Blue	CSZZ-3600-BL
65 Bright red	CSZZ-3600-BR
65-66 Black	CSZZ-3600-BK
65-66 Palamino & parchment ...	CSZZ-3600-PA
65-66 White	CSZZ-3600-WT
66 Aqua	C6ZZ-3600-AQ
66 Dark red	C6ZZ-3600-DR
66 Light blue	C6ZZ-3600-LB
66 Parchment	C6ZZ-3600-PR
67 Black	C7ZZ-3600-BK
67 Blue	C7ZZ-3600-BL
67 Dark red	C7ZZ-3600-DR
67 Ivy Gold	C7ZZ-3600-IG
67 Parchment	C7ZZ-3600-PR
68-69 Black	C8ZZ-3600-BK
68-69 Blue	C8ZZ-3600-BL
68-69 Dark red	C8ZZ-3600-DR
68-69 Ivy Gold	C8ZZ-3600-IG

WOOD STEERING WHEEL

Steering Wheel, Wood



64-73: GM spline, for use w/ Flaming River tilt column
S1MS-3600-WGK

PONY STEERING WHEEL ASSEMBLY

Reproduction of Pony interior simulated wood wheel. Includes horn ring, contact plates and hardware. This wheel was also optional on standard interior cars. Horn center cap sold separately.

Steering Wheel Assembly



65-66: Woodgrain
CSZZ-3600-NK



67: Woodgrain
C70Z-3600-NK



65-66: Wheel only
CSZZ-3600-N

SHOP WITH CONFIDENCE! WE OFFER SUPERIOR-QUALITY PARTS FOR ALL YOUR MUSTANG RESTORATION NEEDS.

STEERING WHEEL CENTER



Deluxe wheel only. Pressure die cast with quality chrome plating.

Includes lens, rim, spring steel snap ring.

Steering Wheel Center

65-66	Concours™ USA	CSZZ-3623-A
65-66	Economy*	CSZZ-3623-AR
66	Shelby ⁵	S2MS-3623-A

STEERING WHEEL COLLAR



Mounts on bottom of original deluxe wheel. Die cast construction like original. Concours plating.

Steering Wheel Collar

65-66	CSZZ-3491-A
67	C70Z-3491-A

UPPER STEERING WHEEL COLLAR



All the detail is contained in the finally available item.

Steering Wheel Collar, Upper

67	dlx.	C70Z-3656-A
----	-----------	-------------

STEERING WHEEL HORN CONTACT PLATE



Deluxe Wood Wheel Horn Contact Plate.

Steering Wheel Horn Contact Plate

65-66	CSZZ-13A808/9
-------	-------	---------------

STEERING WHEEL INSULATOR HARDWARE KIT



Steering Wheel Insulator Hardware Kit

65-67	dlx.	CSZZ-13A890/1MK
-------	-----------	-----------------

STEERING WHEEL INSULATOR KIT



Plastic injection, exact copies of these hard to find originals. Fits on both horn contact rings. Insulates

mounting screws from contact rings. Pony interiors and deluxe wood wheels only.

Steering Wheel Insulator Kit

65-67	CSZZ-13A890/1-A
-------	-------	-----------------

STEERING WHEEL NUT



This really is the nut behind the steering wheel.

Steering Wheel Nut

64-67	350983-5
-------	-------	----------

TIE RODS

INNER TIE ROD



Premium USA brands like Moog, TRW, McQuay Norris or Federal Mogul. Very good quality at a fair price.

Tie Rod, Inner

64-66	6 cyl., manual steering, RH or LH	C3DZ-3A131-AR
64-66	6 cyl., P/S, RH	C4DZ-3A131-D
64-66	6 cyl., P/S, LH	C4DZ-3A131-C
64-66	V8, P/S, LH	CSZZ-3A131-CR
64-66	V8, manual steering RH or LH, P/S RH	CSZZ-3A131-DR
67-69	6 & 8 cyl., RH or LH	C7ZZ-3A131-AR
70	6 & 8 cyl., RH or LH	D0ZZ-3A131-AR
71-73	6 & 8 cyl., RH or LH	D1ZZ-3A131-AR

OUTER TIE ROD



Premium USA brands like Moog, TRW, McQuay Norris or Federal Mogul. Very good quality at a fair price.

Tie Rod, Outer

64-66	6 cyl., manual steering, RH or LH	C3DZ-3A130-AR
64-66	6 cyl., P/S, RH	C4DZ-3A130-C
64-66	6 cyl., P/S, LH	C4DZ-3A131-D
64-66	V8, P/S, LH	CSZZ-3A130-CR
64-66	V8, manual steering RH or LH, P/S RH	CSZZ-3A130-DR
64-66	V8, P/S, LH	CSZZ-3A130-SPEC
67-69	6 & 8 cyl., RH or LH	C7ZZ-3A130-AR
70-73	6 & 8 cyl., RH or LH	D1ZZ-3A130-AR

INNER TIE ROD (IMPORTED)



These quality inner tie rods are imported, but have been designed and built to meet OEM specifications.

Tie Rod (Imported), Inner

64-66	6 cyl., manual steering, RH or LH	C3DZ-3A131-ARI
64-66	V8, P/S, LH	CSZZ-3A131-CRI
64-66	V8, manual steering RH or LH, P/S RH	CSZZ-3A131-DRI
67-69	6 & 8 cyl., RH or LH	C7ZZ-3A131-ARI
71-73	6 & 8 cyl., RH or LH	D1ZZ-3A131-ARI

OUTER TIE ROD (IMPORTED)



These quality outer tie rods are imported, but have been designed and built to meet OEM specifications.

Tie Rod (Imported), Outer

64-66	6 cyl., manual steering, RH or LH	C3DZ-3A130-ARI
64-66	V8, P/S, LH	CSZZ-3A130-CRI
64-66	V8, manual steering RH or LH, P/S RH	CSZZ-3A130-DRI
67-69	6 & 8 cyl., RH or LH	C7ZZ-3A130-ARI
70-73	6 & 8 cyl., RH or LH	D1ZZ-3A130-ARI

TIE ROD ADJUSTING SLEEVE



Name brand quality.

Tie Rod Adjusting Sleeve

64-66	V8, P/S, LH Only	C2WY-3310-AR
64-74	64-66: V8 / 67-73: 6 & 8 cyl., P/S, RH or LH	C2AA-3310-AR
64-73	64-66: V8 / 67-73: 6 & 8 cyl., P/S, RH or LH, Import	C2AA-3310-ARI
64-66	6 cyl., P/S	CSZZ-3310-AR

TIE ROD END DUST SEAL



These aftermarket dust seals are more durable than the original rubber units, and will not blow out under grease pressure. Black only.

Tie Rod End Dust Seal

64-67	Polyurethane	9-13103
67-73	Polyurethane	9-13101

SUSPENSION

COIL SPRINGS

GT COIL SPRING



These springs were original equipment on 1965 - 1966 GT Mustangs. Firmer than stock but offer a softer ride than our 600 pound racing springs. Ideal for anyone

looking for improved handling without sacrificing ride comfort.

Coil Spring, GT

65-66	Silver gray	CSZZ-5310-E
-------	-------------------	-------------

WE PROUDLY FEATURE AUTHENTIC MUSTANG REPRODUCTIONS FROM SCOTT DRAKE ENTERPRISES!



PERFORMANCE COIL SPRING



These springs are custom wound for the performance oriented customer. They feature 600-pound/inch rating and will lower the car

approximately one inch from original stock height

Coil Spring, Performance

64-66 hi-po, black	C5ZZ-5310-P
67-73 hi-po	C7ZZ-5310-P

STOCK COIL SPRING



Replace your old worn out springs with these quality ones made in the U.S.A.

Coil Spring, Stock

64-66 6 cyl.	C5ZZ-5310-A
64-66 V8	C5ZZ-5310-B
67-70 6 cyl.	C7ZZ-5310-A
67-70 BB	C7ZZ-5310-C
67-73 SB	C7ZZ-5310-B

COIL SPRING INSULATOR



Coil Spring Insulator

64-73 Rubber	C4DZ-5415-AR
64-73 Black polyurethane	C4DZ-5415-UR
64-73 Black polyurethane, 1" taller	C4DZ-5415-URT

COIL SPRING PERCH



Features quality stamped steel construction, bushings, nuts, anti-squeak coil protector pads. Excellent quality OEM design.

Coil Spring Perch

64-73 Individually packaged	C4DZ-3388-RI
-----------------------------	-------	--------------

COIL SPRING PERCH BUSHING



This critical bushing takes a lot of abuse from the extra weight and pressure of the coil spring. High-

performance polyurethane replacement bushings.

Coil Spring Perch Bushing

64-73	C4DZ-3388-PB
-------	-------	--------------

CONTROL ARMS

LOWER CONTROL ARM

These lower control arms are authentic reproductions. Comes complete with balljoint, pressed in bushing, grease seal, zerk fitting, washer, nut and cotter key.

Control Arm, Lower



64-66: Black, gray	C4DZ-3078-A
--------------------	-------------



64-66: Black, USA made	C4DZ-3078-AR
------------------------	--------------



67: Black, gray	C70Z-3078-A
-----------------	-------------



67: Black, USA made	C70Z-3078-AR
---------------------	--------------



68-70: Black, USA made	D7DZ-3078-AR
------------------------	--------------



68-73: Black, gray	C80Z-3078-A
--------------------	-------------



68-73: Black	D7DZ-3078-A
--------------	-------------

UPPER CONTROL ARM

These upper control arms are the finest reproductions available. Not rebuilt, all new. Riveted ball joint as original. They come complete with shaft, bushings, ball joint, nut with cotter key, 90 degree zerks, washers and locking nuts.

Control Arm, Upper



64-66: Black, gray	C4DZ-3082-RI
--------------------	--------------



67-73: Black, silver	C7DZ-3082-A
----------------------	-------------



67-73: Black	C7DZ-3082-RI
--------------	--------------

LOWER CONTROL ARM BUSHING



All bushings are graphite impregnated polyurethane. Only fits USA made control arms.

Lower Control Arm Bushing

64-66	4-3101
67-73 1 7/16" outside dia., black	4-3102
67-73 1 9/16" outside dia., black	4-3106

UPPER BALL JOINT KIT



These are the best available. Includes ball joint, rubber boot and mounting hardware.

Upper Ball Joint Kit

64-73 4 bolt, import	C70Z-3049-A
64-73 4 bolt, USA	C70Z-3049-AR
64-73 3 bolt, import	D00Z-3049-A
64-73 3 bolt, USA	D00Z-3049-AR

UPPER CONTROL ARM SHAFT KIT



Complete kit with shaft, bushings, grease seals, bolts, and zerk fittings. Fits original Ford control arm.

Upper Control Arm Shaft Kit

64-66	C3DZ-3047-AR
67-73	C60Z-3047-AR

ZERK FITTING

Our special extended zerk grease fittings are designed so that cutting shock towers for access will not be necessary. Plated to prevent corrosion.

Zerk Fitting



64-73: 90 degree	374714-S
------------------	----------



64-73: Extended	374714-SK
-----------------	-----------

FRAME

SUB FRAME CONNECTOR

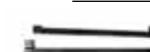

These connectors join front and rear frame rails to make the uni-body much

more rigid. This greatly improves handling by reducing body flex allowing the suspension to react quicker. Black powder coated.

Sub Frame Connector

64-70 CP & FB	C5ZZ-5479-A
---------------	-------	-------------

SHOP WITH CONFIDENCE! WE OFFER SUPERIOR-QUALITY PARTS FOR ALL YOUR MUSTANG RESTORATION NEEDS.

LEAF SPRINGS & SHACKLES

AXLE U BOLT



Each kit contains one U-bolt and two nuts. Grade 8.

Axle U Bolt

64-66 6 or 8 cyl. CSZZ-5705-K
67-73 6 or 8 cyl., except 428 C7ZZ-5705-K
68-69 428 C8ZZ-5705-K

LEAF SPRING

Uses high quality spring steel to assure a smooth stable ride that will last for years. Visit www.scottdrake.com for more information on these springs.

Leaf Spring



64-68: 4 leaf, light duty, stock height
CSZZ-5560-S
64-73: 4 leaf, heavy duty, stock height
CSZZ-5560
64-73: 4.5 leaf, mid eye, lowers 1"
CSZZ-5560-4ME



64-73: 5 leaf, std. eye
CSZZ-5560-HD



64-73: 5 leaf, mid eye, lowers 1"
CSZZ-5560-HPME

64-73: 5 leaf, Reverse eye, lowers 2"
CSZZ-5560-RE

LEAF SPRING BUSHING KIT



Includes eye bushings and shackle bushings.

Leaf Spring Bushing Kit

64-73 CSZZ-5630/5781B

LEAF SPRING EYE BOLT



Grade 8 Hardened bolt kit includes two bolts and two nuts.

Leaf Spring Eye Bolt

64-67 CSZZ-5781-A
68-73 C7ZZ-5781-A

LEAF SPRING EYE BUSHING



Includes quality U.S.A. made rubber bushing.

Leaf Spring Eye Bushing

64-73 CSZZ-5630-R

LEAF SPRING PLATE



This is the plate that secures the rear spring U-bolts to the differential, it also is the mounting point for the rear shock absorber.

Leaf Spring Plate

64-66 RH CSZZ-5798-R
64-66 LH CSZZ-5799-L
67-70 RH C6DZ-5796-A
67-70 LH C6DZ-5796-B

POLYURETHANE LEAF SPRING SHACKLE BUSHING



A set of eight polyurethane shackle bushings. These have a 1/2 inch bore.

Leaf Spring Shackle Bushing, Polyurethane

66-73 1/2" hole, black polyurethane
C6ZZ-5781-BP

RUBBER LEAF SPRING SHACKLE BUSHING



Sets include 8 rubber, leaf spring shackle bushings.

Leaf Spring Shackle Bushing, Rubber

64-65 9/16" hole, rubber CSZZ-5781-BR
66-73 1/2" hole, rubber C6ZZ-5781-BR

REAR END LOWERING KIT



Don't heat your springs or remove leaves. Now its easier and safer to lower the rear end. This kit includes cast aluminum lowering blocks, U

bolts with nylock nuts. Not a universal kit but specially designed for the Mustang.

Rear End Lowering Kit

64-66 1" drop CSZZ-5705-LK1
64-66 2" drop CSZZ-5705-LK2
67-70 1" drop C7ZZ-5705-LK1

ADJUSTABLE SHACKLE KIT



These extreme heavy duty 1/4" thick plates and polyurethane bushings with special grooves which allow

lubrication. Adjustments allow a 3/8" inch lift from stock position.

Shackle Kit, Adjustable

64-73 Adjustable CSZZ-5776-HD

STAINLESS STEEL SHACKLE KIT



Beautiful parts with details like originals. Available in a variety of styles & designs. 1" longer version will raise rear

of car 1/2" higher if rear springs are in new condition. GT version allows more exhaust clearance, plus are easier to install.

Shackle Kit, Stainless Steel

64-73 9/16" rods, dual exhaust, polished stainless
CSZZ-5776-GTSS

64-73 Dual exhaust, 1" longer, polished stainless
CSZZ-5776-GTSSL

64-73 9/16" rods, std., polished stainless
CSZZ-5776-SS

SHACKLE KIT WITH DETAIL GRAY FINISH

Beautiful parts with details like originals. Available in a variety of styles & designs. 1" longer version will raise rear of car 1/2" higher if rear springs are in new condition. GT version allows more exhaust clearance, plus are easier to install.

Shackle Kit with Detail Gray Finish



64-65: 9/16" rods, dual exhaust, gray
CSZZ-5776-GT



64-65: 9/16" rods, std., gray
CSZZ-5776-K



64-73: Dual exhaust, 1" longer, gray
CSZZ-5776-GTL



66-73: 1/2" rods, dual exhaust, gray
C6ZZ-5776-GT



66-73: 1/2" rods, std., gray
C6ZZ-5776-K

WE PROUDLY FEATURE AUTHENTIC MUSTANG REPRODUCTIONS FROM SCOTT DRAKE ENTERPRISES!



MONTE CARLO BARS, EXPORT & TOWER BRACES

COWL BRACE TO COWL HARDWARE



These are the real thing, not just generic nuts and bolts.

Cowl Brace To Cowl Hardware
64-68 CSZB-260

EXTRA STRENGTH EXPORT BRACE



We made these export braces from the Ford print. Heavier than other reproductions. Exact details with correct

deep draw stamping. Available in 3 finishes to compliment any engine compartment. Our export braces fit without prying and jumping on the front end. Greatly reduces twisting of the chassis. Also strengthens the front end and helps reduce shock tower fatigue and cracking.

Export Brace, Extra Strength



64-70: Chrome
CSZZ-16A052-C
64-70: Black
CSZZ-16A052-E
64-70: Satin
CSZZ-16A052-S

AUTHENTIC EXPORT BRACE



Correct for all authentic Shelby's and Fords built for overseas export. Same quality as our extra-strength export braces. These

feature equal mounting hole spacing where brace attaches to firewall.

Export Brace, Authentic

65-66 Shelby, chrome S1MS-16A052-C
65-66 Shelby, black S1MS-16A052-E

EXPORT BRACE MOUNTING PLATE

Reinforcement plate that mounts on cowl.

Export Brace Mounting Plate



64-66
CSZZ-16A052-MP



65-66: Shelby
S1MS-16A052-MP



67-70
C7ZZ-16A052-MP

MONTE CARLO BAR



This extra support also helps prevent shock tower stress cracks. Copied from the original design, our bars feature a new thicker diameter tube and improved fender brackets. We have also stamped square holes in the top of each fender bracket to allow for the use of lower profile carriage bolts. Also available with Heim joint ends, for 65-66 Mustangs, for smoother operation.

Monte Carlo Bar

64-66 Straight, black CSZZ-16A052-ARB
64-66 Straight, chrome CSZZ-16A052-ARC
64-66 Straight, satin CSZZ-16A052-ARM
64-66 Straight, stainless CSZZ-16A052-ARS
64-66 Curved, black CSZZ-16A052-BRB
64-66 Curved, chrome CSZZ-16A052-BRC
64-66 Curved, satin CSZZ-16A052-BRM
64-66 Curved, stainless CSZZ-16A052-BRS
67-68 Straight, black C7ZZ-16A052-ARB
67-68 Straight, chrome C7ZZ-16A052-ARC
67-68 Straight, satin C7ZZ-16A052-ARM
67-68 Straight, stainless C7ZZ-16A052-ARS
67-68 Curved, black C7ZZ-16A052-BRB
67-68 Curved, chrome C7ZZ-16A052-BRC
67-68 Curved, satin C7ZZ-16A052-BRM
67-68 Curved, stainless C7ZZ-16A052-BRS
69-70 Straight, black C9ZZ-16A052-ARB
69-70 Straight, chrome C9ZZ-16A052-ARC
69-70 Curved, black C9ZZ-16A052-BRB
69-70 Curved, chrome C9ZZ-16A052-BRC
71-73 Straight, black D1ZZ-16A052-A

RACE MONTE CARLO BAR



The monte carlo bars with "J" in the part number are equipped with Heim joints for

smoother, simpler installation. Adjustable for perfect fit on every car. Center section is easily removed for major repairs.

Monte Carlo Bar, Race

65-66 Curved, black, w/ Heim joints
..... CSZZ-16A052-BJB
65-66 Curved, stainless, w/ Heim joints
..... CSZZ-16A052-BJS

We have more Monte Carlo options for you to choose from!

4 FINISHES:

Satin, Black, Chrome & Stainless Steel

We have a variety of finishes to match the look of any engine compartment, and all our bars are individually packaged to protect the finish.

CURVED OR STRAIGHT

All of our Monte Carlo bars are available in straight or curved versions.

SHOCK TOWER BRACE



Very nice reproductions. Stamped and formed steel, ready for paint or chrome finish.

Shock Tower Brace

67-68 C7ZZ-16A052-PR
69-70 C9ZZ-16A052-PR
71-73 D1ZZ-16A052/3

SHOCKS AND STRUTS

SHOCK



This KYB gas shock improves handling without sacrificing ride comfort. A very good choice for the daily driver wanting a

smooth ride with the response of a gas shock.

Shock

65-70 Gas Front KYB343146
71-73 Gas Front KYB343156
64-73 Gas Rear KYB343219

GAS-A-JUST SHOCK



KYB Gas-a-just shocks are America's best selling performance gas shock. It's monotube design features a higher gas

pressure which helps to hold the tire to road surface during severe driving conditions. N2 gas helps eliminate shock fading due to aeration and foaming. This shock is the perfect choice for the performance oriented Mustang.

Shock, Gas-A-Just

64-70 Gas-A-Just Front KG-4517
71-73 Gas-A-Just Rear KG-4504
64-73 Gas-A-Just Rear KG-5517

STRUT ROD BRACKET



High quality steel, painted black.

Strut Rod Bracket

64-66 LH CSZZ-6503487-L
64-66 RH CSZZ-6503487-R
67-70 LH, lower C7ZZ-6503487-L
67-70 RH, lower C7ZZ-6503487-R

SHOP WITH CONFIDENCE! WE OFFER SUPERIOR-QUALITY PARTS FOR ALL YOUR MUSTANG RESTORATION NEEDS.

STRUT ROD BUSHING

Each kit comes neatly packaged.

Strut Rod Bushing



64-66: Polyurethane, Set of 4
4-7111



64-66: OEM, rubber, 4 piece kit
C4DZ-3A187-A



64-66: Rubber, 10 piece kit
C4DZ-3A187-AR



67-73: Polyurethane, 6 piece kit
4-7112



67-73: OEM, rubber, set of 4
C60Z-3A187-A



67-73: Rubber, 12 piece kit
C60Z-3A187-AR

STRUT RODS

Cast heavy-duty construction. If your car has been in an accident, check this part for damage.



Strut Rods

64-66 CSZZ-3468-B
68-73 RH, w/ nut C9ZZ-3468-C
68-73 LH, w/ nut C9ZZ-3468-D

SUSPENSION BUMPERS

AXLE BUMPER

Injected molded rubber. Protects floor, and stops 3rd member from contacting floor.



Axle Bumper

65-70 Outer rear, mounts on frame . C3DZ-4730
65-70 Center rear, mounts above 3rd member .
CSZZ-4730

POLYURETHANE FRONT SUSPENSION BUMPER

Stops suspension travel damage.



Front Suspension Bumper, Polyurethane

64-73 Polyurethane C3DZ-3020-P

RUBBER FRONT SUSPENSION BUMPER

Stops suspension travel damage.



Front Suspension Bumper, Rubber

65-66 Rubber C3DZ-3020-A
67-69 Rubber C60Z-3020-A
69-73 Rubber C90Z-3020

SWAY BARS

FRONT SWAY BAR



Our high quality sway bars are made from high carbon steel with hot forged

ends and cadmium plating. Kit contains black polyurethane mount bushings and links with polyurethane grommets. Available in front sizes of 1" or 1-1/8" diameter.

Sway Bar, Front

64-66 1" S1MS-5482-A
64-66 1 1/8" S1MS-5482-B
67-70 1", SB C7ZZ-5482-A
67-70 1 1/8", SB C7ZZ-5482-B
67-70 1", BB, dears oil filter C7ZZ-5482-BB
71-73 1" D1ZZ-5482-A
71-73 1 1/8" D1ZZ-5482-B

REAR SWAY BAR

Rear sway bars minimize body lean when cornering.

Sway Bar, Rear



64-73: 3/4" adjustable
CSZZ-5486-ADJ



64-66: 3/4"
CSZZ-5486



67-70: 3/4"
C7ZZ-5486

SWAY BAR BUSHING



Our black rubber bushings are exact copies of the original. Features correct shoulder and

split for easy installation. Sold in pairs. On 1969 and up, some sway bar brackets may not accommodate the raised anti-slip shoulder, trimming with razor blade may be required.

Sway Bar Bushing

64-66 5/8" C4DZ-5493-B
64-73 1 1/16" C60Z-5493-A
64-73 3/4" C60Z-5493-B
64-73 7/8", GT C60Z-5493-E
64-73 15/16" C60Z-5493-I
64-73 1" C60Z-5493-J

SWAY BAR BUSHING KIT



Our special polyurethane bushings reduce deflection at the bar mounts to quicken the action of stock or aftermarket sway bars. Available in a wide range of

sizes, with matching mount brackets. Includes lubrication groove to prevent squeaking.

Sway Bar Bushing Kit

64-73 Black, 5/8" CSZZ-5486-A
64-73 Black, 1 1/16" CSZZ-5486-B
64-73 Black, 3/4" CSZZ-5486-H
64-73 Black, 13/16" CSZZ-5486-C
64-73 Black, 7/8" CSZZ-5486-D
64-73 Black, 15/16" CSZZ-5486-E
64-73 Black, 1" CSZZ-5486-F
64-73 Black, 1 1/8" CSZZ-5486-G

ADJUSTABLE SWAY BAR END LINK



This allows quick secure adjustments of sway bar. Teflon lined rodbearing also makes steering response instantaneous.

Sway Bar End Link, Adjustable

65-73 CSZZ-5A486-ADJ

POLYURETHANE SWAY BAR END LINK KIT



Our End Link kits include high performance polyurethane bushings. Use polyurethane bushings to eliminate

deflection losses at the ends of the sway bar. Kit includes 2 links.

Sway Bar End Link Kit, Polyurethane

64-66 Black polyurethane CSZZ-5A486-K
67-73 Black polyurethane C7ZZ-5A486-K

RUBBER SWAY BAR END LINK KIT



Our End Link kits include rubber bushings and plated hardware. Kit includes 2 links.

Sway Bar End Link Kit, Rubber

64-67 Rubber CODZ-5A486-BR
68-73 Rubber C20Z-5A486-AR

TRACTION BARS

OVER RIDE TRACTION BAR



Original equipment on 1965 Shelby. Requires modification of rear floor pans.

Traction Bar, Over Ride

65 S1MS-4010-ORTB

WE PROUDLY FEATURE AUTHENTIC MUSTANG REPRODUCTIONS FROM SCOTT DRAKE ENTERPRISES!



UNDER RIDE TRACTION BAR



They greatly reduce wheel hop and improve acceleration. They also keep the rear springs from "unwrapping" during decelerating.

Traction Bar, Under Ride

64-66 Traction Master	TM-1068
64-66 Generic	TM-1068-R
67-70 Traction Master	TM-1069
67-70 Generic	TM-1069-R

TRANSMISSION & DRIVETRAIN

CLUTCH COMPONENTS

CLUTCH ANTI-RATTLE SPRING



Anti-rattle spring for the clutch lever.

Clutch Anti-Rattle Spring

65-68	C6AZ-7562-A
-------------	-------------

CLUTCH CABLE KIT



Kits include adjustable bracket that bolts to stock clutch pedal, firewall support plate and a "tool free"

cable adjuster. Compatible with most brake boosters and work on T5, Tremec and T56 applications with late model bell housings.

Clutch Cable Kit

64-66 T-5 & Tremec	C5ZZ-CCK
67-68 T-5 & Tremec	C7ZZ-CCK
69-70 T-5 & Tremec	C9ZZ-CCK
71-73 T-5 & Tremec	D1ZZ-CCK

CLUTCH DISK



Quality clutch disk available remanufactured or new.

Clutch Disk

64-73 Remanufactured, V8, 10 1/2"	C30Z-7550-F
64-73 Remanufactured, V8, 10" ..	C6DZ-7550-B
66-73 Multi-friction, V8, 10" ..	C6DZ-7550-BMF
67-68 6 cyl., 9", 3.03	C70Z-7550-C
67-73 Remanufactured, BB, 11" ..	C5AZ-7550-G

CLUTCH FORK



The fork that houses the clutch release bearing.

Clutch Fork

65-68 289, 3 or 4 speed transmission, 9 1/4" ...	C50Z-7515-B
68-69 SB, clip on	C80Z-7515-A
68-69 390	C80Z-7515-B
68-69 428	C80Z-7515-D

CLUTCH FORK PIVOT



Heavy duty, Hardware included.

Clutch Fork Pivot

65-67 SB, 289	B9AZ-7522-B
65-68 6 cyl.	C2DZ-7522-B
68-72 SB, 6 cyl.	C8AZ-7522-B

CLUTCH LEVER DUST BOOT



Molded EPDM-neoprene blend. Resist damage from grease and dirt.

Clutch Lever Dust Boot

65 6 cyl.	C30Z-7513-A
65-71 SB, V8	C60Z-7513-C
66-70 6 cyl.	C6GY-7513-A
67-70 390, 427, 428	C60Z-7513-A

CLUTCH PILOT BUSHINGS



A source of vibration in the drivetrain is sometimes a badly worn or cracked clutch pilot bushing.

Clutch Pilot Bushings

64-66 6 cyl.	C0DD-7600-A
64-68 289	C20Z-7600-A
67-71 BB	C7AZ-7600-B
67-73 302, 351	C7AZ-7600-A

CLUTCH ROD



Machined to match originals, plated to resist rust.

Clutch Rod

66 289	C6ZZ-7521-E
67 289	C7ZZ-7521-L
67-70 390, 428	C8ZZ-7521-AR
69-70 302, 351	C90Z-7521-A

CLUTCH ROD ADAPTER



Our adapter is case hardened to OEM specifications and plated for years of service.

Clutch Rod Adapter

67-71 BB	C80Z-7B535-A
----------------	--------------

CLUTCH ROD BUSHING



Nylon plastic injected. Correct original design. Protects clutch and equalizer rods and removes excess play.

Clutch Rod Bushing

64-73	C0AZ-7526-B
-------------	-------------

CLUTCH ROD TO FIREWALL SEAL



Molded rubber, mount in firewall.

Clutch Rod to Firewall Seal

64-66	C5ZZ-7A533-AR
67-73	C60Z-7A533-C

CLUTCH SETS



Excellent upgrade clutch set up. A must for towing or high performance applications. All new components include

pressure plate, clutch disc, throwout bearing and alignment tool.

Clutch Sets

64-73 hi-po, 10 1/2"	C5ZZ-7563-ZHPK
64-73 hi-po, 10"	C5ZZ-7563-ZK
67-73 hi-po, 11", except 1 3/8" input	C7ZZ-7563-ZK

REMANUFACTURED CLUTCH SETS



Quality remanufactured clutch sets, no core charge required. Includes clutch disc, pressure plate, throw out

bearing & alignment tool.

Clutch Sets, Remanufactured

64-73 Remanufactured, V8, 10" ..	C5ZZ-7563-K
67-73 Remanufactured, 351, 390, 11"	C7ZZ-7563-K

Transmission

CLUTCH SPRING

Spring quality and load matches original.
Clutch Spring

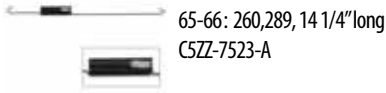

65-66: 260,289, 14 1/4" long
C5ZZ-7523-A

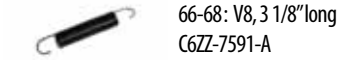

66-68: V8, 3 1/8" long
C6ZZ-7591-A

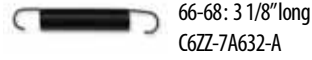

66-68: 3 1/8" long
C6ZZ-7A632-A



69-70: 5 1/2" long
C9ZZ-7523-A

CLUTCH EQUALIZER

CLUTCH EQUALIZER BAR



Quality fabricated metal stamping. Precision welded. New by Drake.

Clutch Equalizer Bar

65-66 289 6 bolt, except hi-po C5ZZ-7528-E
65-66 hi-po 6 bolt C5ZZ-7528-D
67-70 BB C7ZZ-7528-B
67-70 289, 302, except Boss C7ZZ-7528-G
69 351W C9ZZ-7528

CLUTCH EQUALIZER BAR FELT WASHER



This felt washer is the correct thickness to replace the missing washers in your equalizer bar. Two required per bar.

Clutch Equalizer Bar Felt Washer

64-70 SB, 6 cyl. 351517-5

CLUTCH EQUALIZER BAR MOUNT KIT



This kit includes a longer pivot mount. We include bushings, clips and felt washers for both engine and frame side.

Clutch Equalizer Bar Mount Kit

64-70 6 cyl., 260, 289 5 bolt C20Z-7A531-K
65-70 289 6 bolt, 302, 351W C5ZZ-7A531-K

CLUTCH EQUALIZER REPAIR KIT



A must for all manual transmissions. Includes felt washers, nylon ball bushings, washer and clevis clips. Improves clutch operation.

Clutch Equalizer Repair Kit

64-77 6 cyl., SB C1DD-7543-KIT
67-73 BB C1AA-7543-KIT

CLUTCH EQUALIZER BAR TO PEDAL ROD



Clutch Equalizer Bar to Pedal Rod

65 C5ZZ-7521-A
66 13 3/4" C6ZZ-7521-D
67-68 12 1/2" C7ZZ-7521-A
69-70 12 1/2" C9ZZ-7521-C

CLUTCH EQUALIZER BUSHING



Bushing for clutch equalizer bar. Big block only.

Clutch Equalizer Bushing

67-73 BB C1AA-7543-A

CLUTCH EQUALIZER PIVOT BRACKET

This bracket bolts to the frame and acts as the inner pivot point for the clutch equalizer bar.
Clutch Equalizer Pivot Bracket



64-70: All except BB
C5ZZ-7507-A



67-70: BB, frame side
C7ZZ-7507-BR



67-70: BB, engine side
C7ZZ-7A572-BR

71-73: 302/351, engine side
D1ZZ-7A572-A

CLUTCH EQUALIZER SOCKET



Clutch Equalizer Socket

71-73 CODD-7517-A

CLUTCH EQUALIZER SOCKET RETAINER



Clutch Equalizer Socket Retainer

71-73 C5AZ-7B545-A

CLUTCH PEDAL

CLUTCH PEDAL



Exact reproductions of the originals. Made in the U.S.A.

Clutch Pedal

65-66 6 & 8 cyl. C6ZZ-7519-A
67-68 6 & 8 cyl., requires minor modification for 68
C7ZZ-7519-A

CLUTCH PEDAL PAD



These reproduction pads are high quality replacements for worn or missing original pads.

Clutch Pedal Pad

65-68 C5ZZ-7A624-B
69-73 C9ZZ-7A624-A

CLUTCH PEDAL PAD TRIM

Stainless steel.



Clutch Pedal Pad Trim

65-68 C5ZZ-7B544-A
69-73 C9ZZ-7B544-A

CLUTCH PEDAL REPAIR SHAFT



Includes machined pedal shaft, washer and special pin.

Clutch Pedal Repair Shaft

64-70 C5ZZ-2478-AK

CLUTCH PEDAL RETURN SPRING

Heat treated to match original resistance.
Clutch Pedal Return Spring



64-68: Painted black
C2AZ-7534-A

Clutch Pedal Return Spring



69-73: inc. nylon bushings
C80Z-7534-B

CLUTCH PEDAL RETURN SPRING BRACKET

Now available from Scott Drake. Made of heavy gauge steel with a satin black painted finish. Correct threads and hole patterns.

Clutch Pedal Return Spring Bracket



64-66
C5ZZ-7535-A



67-68
C7Z-7535-B



69-70
C9Z-7535-A

CLUTCH PEDAL SPRING INSULATOR



Injection molded plastic stops underdash squeaking from clutch pedal return spring. 2 required per car.

Clutch Pedal Spring Insulator

64-70C1DZ-7A630-A

CLUTCH PEDAL STOP



Stamped steel construction, features woven fabric insulator.

Clutch Pedal Stop

64-66C20Z-7A630-A

CLUTCH PEDAL ROLLER BEARING MASTER REBUILD KIT



This kit uses roller bearings to reduce pedal pressure and will last for years. 1969 through 1973 may require modification to

the pedal bracket assembly so bushing will fit. 10 piece kit includes instructions.

Clutch Pedal Roller Bearing Master Rebuild Kit

64-70C5ZZ-2478-RBMK

CLUTCH PEDAL SUPPORT BUSHING REPAIR KIT



An easy fix for sloppy or worn clutch pedal support bushings. Includes 2 machined bushings, 4 plastic bushings and 2

snap rings. 1969 through 1973 may require modification to the pedal bracket assembly so bushing will fit. 8 piece kit includes instructions. *We highly recommend the below roller bearing kit.*

Clutch Pedal Support Bushing Repair Kit

64-70378200-K

CLUTCH PEDAL SUPPORT ROLLER BEARING REPAIR KIT



These bearings will reduce pedal pressure and last for years. 1969 through 1973 may require modification to the pedal bracket

assembly so bushing will fit. 10 piece kit includes instructions.

Clutch Pedal Support Roller Bearing Repair Kit

64-73C5ZZ-2478-RB

DIFFERENTIAL

BACKING PLATE AXLE GASKET



Aftermarket authentic gasket.

Backing Plate Axle Gasket

64-73 InnerC5ZZ-1001-I

64-73 OuterC5ZZ-1001-O

DIFFERENTIAL GASKET



Stop those driveway spots with a new differential gasket.

Differential Gasket

64-73 8"C5ZZ-4035-A

DIFFERENTIAL REBUILD KIT

Includes crush sleeve, pinion depth shims, pinion seal, gasket, pinion nut, ring gear bolts, carrier side shims, rear pinion bearing and race, front pinion bearing, and race, carrier bearings and races.

Differential Rebuild Kit



64-73: 8" rear end
C5ZZ-4141-RK



64-73: 9" rear end, 28 spline, posi.
C7Z-4141-RKP28



65-73: 9", 28 spline, non posi
C7Z-4141-RK028

DIFFERENTIAL SEAL KIT



Includes crush sleeve, pinion depth shims, pinion seal and gasket. 9" version pictured. Note: 8" version does not come with actual

gasket. Tube of form-a-gasket included.

Differential Seal Kit

64-73 V8, 8" rear endC5ZZ-4141-SK

64-73 V8, 9" rear endC7Z-4141-SK

REAR END VENT HOSE KIT



Rubber hose that allows rear end to breath. Runs from brake junction block up to body. Includes attaching hardware.

Rear End Vent Hose Kit

64-70MVH001

RING & PINION



Ring & Pinion

64-73 8", 3.00 to 1C5ZZ-4209-300

DRIVELINE

DRIVELINE SAFETY LOOP



Mounts at seat belt holes to eliminate the need for drilling or welding. Prevents drive shaft from dropping to ground when u-joints

fail. A must for all high performance vehicles.

Driveline Safety Loop

64-73C5ZZ-4602-L



U-JOINT

American made aftermarket replacements.

U-Joint

- 64-66 6 cyl., front, inside snap rings C5ZZ-4635-FA
- 64-66 V8, front, inside snap rings C5ZZ-4635-FB
- 64-66 6 cyl., rear, inside snap rings C5ZZ-4635-RA
- 64-66 V8, rear, inside snap rings ... C5ZZ-4635-RB
- 65-66 V8, rear, outer snap rings ... C5ZZ-4635-RC
- 67-73 Front, 3" outside dia. yoke span C7ZZ-4635-FA
- 67-73 Front, 3 7/8" outside dia. yoke span C7ZZ-4635-FB
- 67-73 V8, rear, 3" outside dia. yoke span C7ZZ-4635-RA
- 67-73 V8, rear, 3 7/8" outside dia. yoke span C7ZZ-4635-RB

YOKE

U.S.A. made aftermarket replacement.



Yoke

- 64-73 V8, C-4, 3 or 4 speed, 28 spline C3AZ-4841-D
- 64-73 5.0V8 FOAZ-4841-A
- 65-70 V8, T-5 T5-YOKE
- 65-73 SB, inside snap rings C5DZ-4841-A

KICKDOWN LEVER

KICKDOWN LEVER

Stamped steel construction with welded machined stud.



Kickdown Lever

- 67-68 6 & 8 cyl. C6OZ-7D026

NEUTRAL SAFETY SWITCH

NEUTRAL SAFETY SWITCH

High quality replacement switches from the original supplier to Ford.



Neutral Safety Switch

- 64-67 C-4, before 12-15-66 C4AZ-7A247-C
- 67-69 C-4, C-6, after 12-15-66 .. C9ZZ-7A247-B
- 70-73 C-4 D0ZZ-7A247-A
- 72-73 C-6 D2ZZ-7A247-A

NEUTRAL SAFETY SWITCH HARNESS



Very nice, authentic reproduction. Features correct molded connectors.

Neutral Safety Switch Harness

- 64-65 C5ZZ-7A240-NS
- 66 C6ZZ-7A240-NS

SHIFTER (AUTOMATIC)

AUTOMATIC SHIFTER ASSEMBLY



This is a complete shifter including the reverse lock out mechanism. Great chrome and sturdy construction.

Shifter Assembly, Automatic

- 67-68 Console cars only C7ZZ-7210-KIT

SHIFTER COVER ASSEMBLY AND HANDLE KIT



Includes shift handle, cover assembly, new bushings and mounting hardware.

Shifter Cover Assembly and Handle Kit

- 64-66 KIT-TRN-1
- 67-68 KIT-TRN-2

AUTOMATIC SHIFTER HANDLE



A variety of shift handles to match your vehicle. (Note: C5ZZ-7213-F is an exact copy of the 65-67 version.

68-73 standard interior's shift handle was slightly different in appearance. Early 1964 cars had a smaller handle.)

Shifter Handle, Automatic

- 64-73 Chrome, high quality C5ZZ-7213-F
- 67-68 Parchment, dlx. C8OZ-7213-PR
- 67-68 Saddle, dlx. C8OZ-7213-SA
- 67-69 Dark blue, dlx. C8OZ-7213-BL
- 67-73 Black, dlx. C8OZ-7213-BK
- 67-73 Black, leather, dlx. C8OZ-7213-BKL
- 68-69 Maroon, dlx. C8OZ-7213-MR

SHIFTER BUTTON



C5ZZ-7C488-C features plastic injection. C8OZ-7C488-A features die-cast zinc construction and chrome plating.

Shifter Button

- 64-73 auto. C5ZZ-7C488-C
- 68-71 auto., LH C8OZ-7C488-A

AUTOMATIC SHIFTER SELECTOR LEVER



Chrome plated lever with new cable, bushings and internal mechanisms.

Shifter Selector Lever, Automatic

- 64-68 64-66: All
- 67-68: w/out console C5ZZ-7210-A
- 69-73 69-73: All C9ZZ-7210-A

SHIFTER COVER ASSEMBLY

Quality chrome finish over zinc die cast. Features correct details and paint. Seal & Dial included.

Shifter Cover Assembly



- 64: Concours, w/out arrows C4ZZ-7D394



- 65-66: Concours C5ZZ-7D394



- 67-68: Not exact copy C7ZZ-7D394



- 67-68: Concours C7ZZ-7D394-P



- 69-70: Concours, will also fit 1971-73 for an upgraded look C9ZZ-7D394



- 71: D1ZZ-7D443-A

CONSOLE SHIFTER PLATE ASSEMBLY



Precision stamped steel construction, painted black, includes shift dial, selector slide and proper hardware.

Shifter Plate Assembly, Console

- 65-66 C5ZZ-7D350-K

WE PROUDLY FEATURE AUTHENTIC MUSTANG REPRODUCTIONS FROM SCOTT DRAKE ENTERPRISES!



CONSOLE SHIFT SIDE SEAL



Die cut from a tough, wear resistant material which matches the original. Automatic transmissions only.

Console Shift Side Seal

- 64-66CSZZ-7C445-A
- 67-68C7ZZ-7C445-A

SHIFTER SEAL

High quality rubber molded around a flexible steel insert. Insert is cadmium plated to prevent rust.

Shifter Seal



- 64-68: Non-console
CSZZ-7D351



- 69-73: All
D1ZZ-7D351-A

SHIFTER DIAL

Precision molded clear plastic with black or clear background under red arrows and white letters.

Shifter Dial



- 64: Early 64, Black, no arrows, non-console
C4ZZ-7A213-A
- 64-66: Black, for center console
CSZZ-7A213-D
- 65-66: Black, non-console
CSZZ-7A213-A
- 67-68: Black, non-console
C7ZZ-7A213-A
- 69-70: Clear, no arrows, All
C9ZZ-7E271-A

CONSOLE SHIFTER SELECTOR ROD



This is the rod that connects the shifter to the indicator in the console for automatic transmissions.

Console Shifter Selector Rod

- 67-68C7ZZ-7E148-A

SHIFTER BUSHING



Shifter Bushing

- 64-73 auto.CSZZ-7A133-A
- 65-67 auto., 6 piece kitB9AZ-7343-A

SHIFTER CABLE



Shifter Cable

- 65-73 auto.CSZZ-7D246-A

SHIFTER LINKAGE ROD



Our linkage rod includes the connector that is often worn and not included with the competitions linkage rod. Dark grey finish to prevent rust.

Shifter Linkage Rod

- 64-66 C-4CSZZ-7326-A
- 67-68 C-4C7ZZ-7326-A

SHIFTER COVER RETAINING PLATE



Painted black steel stamping. Fits under the shift bezel, on top of the shift lever bucket.

Shifter Cover Retaining Plate

- 64-68CSZZ-7B233-A

SHIFTER HOUSING TO FLOOR SEAL



Die-cut rubber.

Shifter Housing to Floor Seal

- 65-68CSZZ-7370
- 69-73C9ZZ-7370

SHIFTER (MANUAL)

BILLET MANUAL SHIFTER KNOB

* A variety of shift knobs to put a nice touch on your shifter.



Shifter Knob, Billet Manual



- 64-73: Mustang logo, 4 Speed,
1/2" x 20"
CSZZ-7213-BL



- 64-66: Black, 4 speed, 1/2" x 20
B-7213-A



- 64-66: Satin, 4 speed, 1/2" x 20
B-7213-AC



- 67-68: Satin, 4 speed, 1/2" x 20
B-7213-BC



- 68-69: Black, dlx., 4 speed, 1/2" x 20
B-7213-C



- 68-69: Satin, dlx., 4 speed, 1/2" x 20
B-7213-CC



- 64-66: Satin, 4 speed, Falcon, Cobra,
Tiger, 1/2" x 20
B-7213-CFTC



- 64-66: Satin, 5 speed, 12 mm
threads
B-7213-E5AC



- 67-68: Black, 5 speed, 12mm
threads
B-7213-E5B



- 68-69: Black, dlx., 5 speed, 12mm
threads
B-7213-E5C



- 65-70: Satin, 5 speed, Hurst threads
B-7213-H5C



- 65-70: Satin, 4 speed, Hurst threads,
3/8" x 16
B-7213-HC

Shifter Knob, Billet Manual



64-66: Satin, 5 speed, 1/2"x20
B-7213-T5AC



68-69: Black, dlx., 5 speed
B-7213-T5C



68-69: Satin, dlx., 5 speed
B-7213-T5CC

ORIGINAL MANUAL SHIFTER KNOB

Truly a fine reproduction made from the same material as the originals.

Shifter Knob, Original Manual



64-66: Black, orig. Bakelite plastic,
4 speed
C5ZZ-7213-A



64-67: Black, orig. Bakelite plastic,
3 speed
C5ZZ-7213-H



65-67: Black, orig. Bakelite plastic,
5 speed
C5ZZ-7213-T5



67-68: Black, orig. Bakelite plastic,
4 speed
C7ZZ-7213-A



67-68: Black, orig. Bakelite plastic,
5 speed
C7ZZ-7213-T5



67-68: Black, orig. Bakelite plastic,
3 speed
C80Z-7213-B



68-69: Woodgrain, dlx., plastic
injection copy of orig., 4 speed
C80Z-7213-A



68-69: Woodgrain, dlx., Plastic
injection, 5 speed
C80Z-7213-T5

MANUAL SHIFTER SELECTOR LEVER



Factory detailing and triple chrome plating distinguish our tubular shift handles from the rest. Cable and T-lever included.

Shifter Selector Lever, Manual

65-67 4-speed C5ZZ-7210-M
65-67 5-speed C5ZZ-7210-T
68-69 4-speed C8ZZ-7210-A

SHIFT LEVER GROMMET



Replace those worn out or missing shift lever grommets to fix that sloppy shift lever.

Shift Lever Grommet

64-70 Bulk 379998-5
64-73 Pair, packaged 379998-SK

SHIFT LEVER REBUILD KIT



This kit is used to keep tension on the shifter where it connects to the shift linkage. A sign that this kit is needed is a wobbly, loose shift lever.

Shift Lever Rebuild Kit

64-68 4 speed C5ZZ-7208-A
65-68 3 speed C5ZZ-7208-B

SUPER SHIFT LEVER REBUILD KIT



This kit is used to keep tension on the shifter where it connects to the shift linkage. A sign that this kit is needed is a wobbly, loose shift lever. Kit includes shoulder bolts.

that this kit is needed is a wobbly, loose shift lever. Kit includes shoulder bolts.

Shift Lever Rebuild Kit, Super

64-68 4 speed C5ZZ-7208-AK
64-68 3 speed C5ZZ-7208-BK

SHIFT LEVER SHOULDER BOLT



Not always included in shifter rebuild kits, but necessary for a complete shifter

rebuild. These are NOT generic bolts, they are exact copies. High grade zinc plated bolts. Correct shoulders and nylon lock.

Shift Lever Shoulder Bolt

65-68 379818-5

LEATHER SHIFTER BOOT



These leather shift boots look great! Our 64-73 boots feature draw string at the neck and rubber insulated metal mounting plate.

Shifter Boot, Leather

64-68 Leather w/ draw string C5ZZ-7277-L
69-73 Leather w/ draw string C9ZZ-7277-L

LOWER SHIFTER BOOT



This rubber boot mounts on the shifter housing underneath the shift boot. Most cars are missing this important part. It was

designed to keep dirt and moisture out of the shifter box and reduce noise coming through the shifter hole. An excellent reproduction.

MCA approved.

Shifter Boot, Lower

65-68 3 speed C6ZZ-7138-B
65-68 4 speed C6ZZ-7138-C

RUBBER SHIFTER BOOT



An exact copy of the original. Compression molded E.P.D.M. rubber. Features a textured skin that matches the original appearance exactly. Ours

has a steel insert just like the originals.

Shifter Boot, Rubber

64-68 3 & 4 speed C5ZZ-7277-B
69-70 3 & 4 speed C9ZZ-7277-A
70 Hurst, 4 speed D0ZZ-7277-B

SHIFTER BOOT RETAINER

These pieces really dress up the area around the shifter

Shifter Boot Retainer



64-68: Chrome, dlx., 3 & 4 speed,
w/out console
C4ZB-7262-B
64-68: Satin, dlx., 3 & 4 speed,
w/out console
C4ZB-7262-S

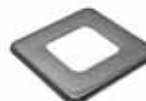

64-68: Chrome, manual w/out
console
C5ZZ-7262-C



69-70: Chrome, manual
C9ZZ-7262-C

SHIFTER BRACKET



This previously hard to find part comes complete with proper fitting shaft.

Shifter Bracket

65-67 3 & 4 speed C5ZZ-7210-D

WE PROUDLY FEATURE AUTHENTIC MUSTANG REPRODUCTIONS FROM SCOTT DRAKE ENTERPRISES!



Transmission

SHIFTER LINKAGE



4 speed top loader linkage includes 3 rods, 3 arms, 6 washers and 6 pins. Fits Mustang and Cougar only.

Shifter Linkage

64-68 CSZZ-7285-LRK

SHIFTER LINKAGE RETAINING CLIP



Heat treated wire clip that secures shift linkage rod. Automatic or manual transmission.

Shifter Linkage Retaining Clip

64-73 352358-5

SHIFTER MOUNT PLATE



Plate mounts the shifter to the transmission. Top loader only.

Shifter Mount Plate

64-73 4 speed CSZZ-7E046-T

SHIFTER MOUNTING PLATE EXTENSION



This conversion plate allows the use of a Falcon, Fairlane or Torino 4 speed

toploader to be installed into a Mustang. Relocates shifter rearward to correct position.

Shifter Mounting Plate Extension

64-73 4 speed CSZZ-7E046-A

SPEEDOMETER CABLES & GEARS

SPEEDOMETER CABLE



Quality aftermarket copies. Attaches from rear of speedometer to transmission. 1967-70 now come with correct firewall

grommet, a Scott Drake exclusive!

Speedometer Cable

64-66 auto. & 3 speed, 60" long C5DZ-17260-A

64-66 4 speed, T/L, 68" long C5OZ-17260-A

67-68 auto. & 3 speed, 68" long .C7ZZ-17260-A

67-68 4 speed, T/L, 80" long C7ZZ-17260-B

69-70 4 speed, except drag pack C9Z-17260-B

69-73 auto. & 3 speed C9Z-17260-A

INTERNAL SPEEDOMETER GEAR



Speedometer Gear, Internal

64-66 6 teeth, 4 speed T/L (pink) ... CSZZ-17285A

64-73 7 teeth, 4 speed T/L (black) C4DZ-17285A

SPEEDOMETER GEAR



Injection molded nylon. Please confirm teeth count and teeth direction. Note: 4-speed toploaders

have reversed tooth direction. Also note: color matching does not guarantee correct gear.

Note: not returnable if package is opened.

Speedometer Gear

64-73 16 teeth, auto. & 3 speed ... CODZ-17271-A

64-73 16 teeth, 4 speed T/L (orange) C2DZ-17271-J

64-73 17 teeth, auto. & 3 speed ... CODZ-17271-C

64-73 17 teeth, 4 speed T/L (purple) .C2DZ-17271-G

64-73 18 teeth, auto. & 3 speed (yellow)

CODD-17271-B

64-73 18 teeth, 4 speed Top-Loader .. C2DZ-17271-A

64-73 19 teeth, auto. & 3 speed (pink)

CODZ-17271-B

64-73 19 teeth, 4 speed T/L C2DZ-17271-B

64-73 20 teeth, auto. & 3 speed (black)

C1DZ-17271-A

64-73 20 teeth, 4 speed T/L C2DZ-17271-C

64-73 21 teeth, auto. & 3 speed ... CODZ-17271-D

64-73 21 teeth, 4 speed T/L C2DZ-17271-D

SPEEDOMETER GEAR RETAINING CLIP



Secures speedometer cable gear to the end of the cable.

Speedometer Gear Retaining Clip

64-73 C1DZ-17292-A

TRANSMISSION CONVERSION PARTS

T5 CONVERSION KIT



These conversion kits makes it easy to install a late model V8 T5 transmission in a 1965-70 Mustang.

T5 transmissions will

increase gas mileage and top end speed. No cutting of the floor pan required. Bell housing modification required. Bell housing not included.

T5 Conversion Kit

65-66 T-5 bellhousing T5-65-KIT

65-66 orig. bellhousing, 289, 302 . T5-650E-KIT

67-70 T-5 bellhousing T5-67-KIT

67-70 orig. bellhousing, 289, 302 . T5-670E-KIT

TRANSMISSION CROSSMEMBER BAR



This is required to convert your car to a T5 five speed transmission. 65-66 version

includes parking brake bracket.

Transmission Crossmember Bar

65-66 T-5, V8 T5-BAR-A

67-70 T-5, V8 T5-BAR-B

TRANSMISSION FULCRUM



This is required to convert a late model T-5 bell housing to accept the early Mustang clutch fork. Available for 65-67 spring type clutch forks

and for 68-70 prong type clutch forks.

Transmission Fulcrum

65-67 Spring type T5-FSB-KIT-A

68-70 Prong type T5-FSB-KIT-B

TRANSMISSION MOUNT



Perfect replacement for your broken tranny mount. Also can be used when converting to T-5

Transmission Mount

64-73 All C4DZ-6068-A

TRANSMISSION FLYWHEELS, RING GEARS, AND BELLHOUSINGS

TRANSMISSION FLYWHEEL



American aftermarket brand at a fantastic price.

Transmission Flywheel

64-68 157 teeth, 289, 3 & 4 speed C3AZ-6375-J

64-73 164 teeth, 302, 351 C6TZ-6375-C

TRANSMISSION RING GEAR



Made by a premier manufacturer in the U.S.A. All are top quality. Easily replaces those missing or damaged teeth on flywheels.

Transmission Ring Gear

64-68 157 teeth, 260, 289 C2OZ-6384-B

68-73 164 teeth, 302, 351 CSAZ-6384-D

67-70 184 teeth, 390, 428 CSAZ-6384-A

SHOP WITH CONFIDENCE! WE OFFER SUPERIOR-QUALITY PARTS FOR ALL YOUR MUSTANG RESTORATION NEEDS.

TRANSMISSION GEARS, SYNCHROS AND SHAFTS

TRANSMISSION GEAR

Made in the U.S.
Premium brand.



Transmission Gear

- 64-66 Reverse idler gear, 3 speed, 6 cyl.
C1DR-7141-A
- 64-73 Reverse idler gear, 3 speed,
64-73 8 cyl., 67-73 6 cyl. .. C5AZ-7141-C
- 64-73 Reverse idler gear, 4 speed T/L .. C4AZ-7D223-B
- 64-66 Reverse idler gear, Borg Warner T-10
4 speed C2AZ-7141-B
- 64-66 Reverse, 39 teeth, Borg Warner T-10
4 speed C2AZ-7100-B
- 64-66 1st/reverse, 3 speed, 6 cyl. . C1DR-7100-A
- 64-73 1st gear, 3 speed, 64-73 8 cyl., 67-73 6 cyl.
C5AZ-7A029-C
- 64-73 1st gear, 32 teeth, 4 speed T/L .. C4AZ-7A209-A
- 64-66 1st gear, 36 teeth, Borg Warner T-10 4
speed C2AZ-7100-C
- 64 2nd gear, 19 teeth, 3 speed, 170
C1DZ-7102-B
- 65-66 2nd gear, 20 teeth, 3 speed, 6 cyl.
C50Z-7102-A
- 64-73 2nd gear, 25 teeth, 3 speed, 65-73 8 cyl.,
67-73 6 cyl. C5AZ-7102-F
- 64-73 2nd gear, 28 teeth, 4 speed T/L .. C4AZ-7102-D
- 64-66 2nd gear, 31 teeth, 4 speed T/L .. C4DZ-7102-A
- 64-66 2nd gear, 30 teeth, Borg Warner T-10
4 speed C3AZ-7102-H
- 64-73 3rd gear, transmission w/ 2.32 1st gear ratio,
4 speed T/L C4AZ-7B340-C
- 64-66 3rd gear, transmission w/ 2.78 1st gear
ratio, 4 speed T/L C4DZ-7B340-B
- 65-66 3rd gear, 28 teeth, Borg Warner T-10
4 speed C30Z-7B340-B

TRANSMISSION CLUSTER GEAR

Aftermarket U.S. brand.



Transmission Cluster Gear

- 64 3 speed, 170 C1DR-7113-A
- 65-66 3 speed, 200 C50Z-7113-A
- 64-73 3 speed, 64-73 8 cyl., 67-73 6 cyl.
C5AZ-7113-G
- 65 4 speed C30Z-7113-C
- 64-73 4 speed T/L, 2.32 ration C4AZ-7113-B
- 64-66 4 speed T/L, 2.78 ratio C4DZ-7113-B

TRANSMISSION COUNTERSHAFT PIN

Quality machined pin,
aftermarket brand.



Transmission Countershaft Pin

- 64-73 Borg-Warner T-10, 9.43" long, .878" dia.
..... 8L-7111
- 64-66 3 speed, 6 cyl. CODR-7111-A
- 65-73 3 speed, 65-73 8 cyl., 67-68 6 cyl., 6
31/64" long C3AZ-7111-B
- 64-73 4 speed T/L, 10 1/8" long, .8920" dia.
C4AZ-7111-A

TRANSMISSION INPUT SHAFT

Quality aftermarket
brand, U.S.A.



Transmission Input Shaft

- 64 16 teeth, 3 speed, 170 C2DZ-7017-B
- 65-66 8 3/4", 3 speed, 65-66 8 cyl., 67-73 6 cyl.
C5AZ-7017-B
- 66 8 3/4", 3 speed, 6 cyl. C60Z-7017-A

TRANSMISSION MAINSHAFT

Made in U.S.A. Quality
built.



Transmission Mainshaft

- 64-66 25 spline, 3 speed, 6 cyl. ... C20Z-7061-B

TRANSMISSION SYNCHRONIZER

All made from name
brand supplies. All
U.S.A.



Transmission Synchronizer

- 64-73 1st gear & reverse, 3 speed, 64-73 8 cyl.,
67-73 6 cyl. C6AZ-7124-B
- 64-73 1st & 2nd gear, w/ reverse, 4 speed T/L ..
C4AZ-7124-B
- 64-66 1st & 2nd gear, 36 teeth, Borg Warner
T-10 4 speed C2AZ-7124-H
- 64-73 2nd & 3rd gear, 3 speed, 6 cyl. C2DZ-7124-A
- 64-73 2nd & 3rd gear, 3 speed, 64-73 8 cyl.,
67-73 6 cyl. C8TZ-7124-G
- 64-73 3rd & 4th gear, 4 speed T/L .. C4AZ-7107-D
- 64-66 3rd & 4th gear, Borg Warner T-10 4 speed
C2AZ-7124-C

TRANSMISSION SYNCHRONIZER FORK



Transmission Synchronizer Fork

- 64-73 1st & 2nd gear, 4 speed T/L C4AZ-7230-B
- 64-66 1st-4th gear, Borg Warner T-10 4 speed .
C2AZ-7230-A
- 64-73 3rd & 4th gear, 4 speed T/L C4AZ-7230-A

TRANSMISSION KITS

AUTOMATIC TRANSMISSION MASTER REBUILD KIT



These kits include
everything necessary
to rebuild your tired
and leaking automatic
transmission. Parts

included are all paper gaskets, pan gasket,
rubber O rings, rubber lip seals, metal clad
seals, sealing rings, friction clutches, steel
clutch plates, filter, clutch band, and bushings.
Vacuum modulator sold separately.

Automatic Transmission Master Rebuild Kit

- 64-69 C-4 C5ZZ-7005-MK
- 67 C-6 C7ZZ-7005-MK
- 68-73 C-6 C8ZZ-7005-MK
- 69-73 FMX C9ZZ-7005-MK
- 70-73 C-4 DOZZ-7005-MK

AUTOMATIC TRANSMISSION OVERHAUL KIT



This kit includes all
paper gaskets, pan
gasket, rubber O rings,
rubber lip seals, metal
clad seals, sealing rings
& friction clutches.

Automatic Transmission Overhaul Kit

- 64-69 C-4 C5ZZ-7005-K
- 67-73 C-6 C7ZZ-7005-K
- 69-73 FMX C9ZZ-7005-K
- 70-73 C-4 DOZZ-7005-K

**WE PROUDLY FEATURE AUTHENTIC MUSTANG
REPRODUCTIONS FROM SCOTT DRAKE ENTERPRISES!**



AUTOMATIC TRANSMISSION SHIFT KIT



These shift kits are a must for anybody wishing to improve economy, performance and durability of their automatic transmission.

Shift kits firm up 1-2 and 2-3 shifts and improve passing gear response.

Automatic Transmission Shift Kit

65-66	C-4, Cruise-o-matic, basic kit	CSZZ-7A100-SK
67-69	C-4, Select-o-matic, reprogramming kit ...	C7ZZ-7A100-RPK
67-69	C-4, Select-o-matic, basic kit	C7ZZ-7A100-SK
67-73	C-6, reprogramming kit ..C8ZZ-7A100-RPK	
67-73	C-6, basic kit	C8ZZ-7A100-SK
69-73	FMX, basic kit	C9ZZ-7A100-SK
70-72	C-4, basic kit	DOZZ-7A100-SK
70-73	C-4, Select-o-matic, reprogramming kit ...	DOZZ-7A100-RPK
73-80	C-4 & C-5, basic kit	D3ZZ-7A100-SK

MANUAL TRANSMISSION MASTER REBUILD KIT



Master rebuild kits include brass synchro rings, input and output oil seals, tailshaft bushing, input and

output bearings and all paper gaskets. Most also include thrust washers, needle bearings and small parts kit. Please refer to photo on website for contents of each kit.

Manual Transmission Master Rebuild Kit

64-65	Borg Warner T-10 4 speed, V8	CSZZ-7005-R4B
64-66	3 speed, 2.77 ratio, 6 cyl. . C3DZ-7005-R3	
64-66	4 speed, 6 cyl.	C3DZ-7005-R4
64-73	3 speed, 64-73 8 cyl., 67-73 6 cyl.	CSZZ-7005-R3
64-73	4 speed T/L, V8 except 427, 428, 429	CSZZ-7005-R4T
67-73	4 speed T/L w/ 1 3/8" input, BB	C7ZZ-7005-R4T

MANUAL TRANSMISSION OVERHAUL KIT



These kits are the same as Master Rebuild Kits except they do not include brass synchro rings.

Manual Transmission Overhaul Kit

64-65	Borg Warner T-10 4 speed, V8	CSZZ-7005-OH4B
64-66	3 speed, 2.77 ratio, 6 cyl. ..C3DZ-7005-OH3	
64-66	4 speed, 6 cyl.	C3DZ-7005-OH4
64-73	3 speed, 64-73 8 cyl., 67-73 6 cyl.	CSZZ-7005-OH3
64-73	4 speed T/L, V8, except 427, 428, 429	CSZZ-7005-OH4T
67-73	4 speed T/L w/ 1 3/8" input, BB	C7ZZ-7005-OH4

TRANSMISSION OIL PARTS

TRANSMISSION DIP STICK



All dip sticks have correct markings for accurate readings.

Transmission Dip Stick

64-73	C-4, zinc	C6AZ-7A020-B
64-73	C-4, chrome	C6AZ-7A020-C

TRANSMISSION DIP STICK TUBE



Fits C4 transmissions. O-ring included

Transmission Dip Stick Tube

64-73	C-4, black	C60Z-7A228-B
64-73	C-4, chrome	C60Z-7A228-C

TRANSMISSION FILTER



Clean filters are essential for proper transmission function and longevity.

Transmission Filter

64	C-4, w/ gaskets	C4ZZ-7A098-F
65-69	C-4, w/ gaskets	C5ZZ-7A098-F
67-73	C-6, w/ gaskets	C7ZZ-7A098-F
69-73	FMX, w/ gaskets	C9ZZ-7A098-F
70-73	C-4, w/ gaskets	DOZZ-7A098-F

TRANSMISSION OIL COOLER LINE



Quality precision bent lines. Runs from oil cooler in radiator to transmission. Does not include rubber hoses or clamps on 1964-1965 models. Each pair

does include two retainer clips.

Transmission Oil Cooler Line

64-65	6 cyl., steel	MOL001
64-65	6 cyl., stainless	MOL001S
64-65	V8, steel	MOL003
64-65	V8, stainless	MOL003S
66	6 cyl., steel	MOL004
66	6 cyl., stainless	MOL004S
66	V8, steel	MOL005
66	V8, stainless	MOL005S
67-70	C-4, V8, steel	MOL002
67-70	C-4, V8, stainless	MOL002S
67-70	C-6, 390, 428, steel	MOL006
67-70	C-6, 390, 428, stainless	MOL006S
67-70	C-4, 6 cyl., steel	MOL010
67-70	C-4, 6 cyl., stainless	MOL010S
69-70	FMX, 351, steel	MOL007
69-70	FMX, 351, stainless	MOL007S
71	FMX, steel	MOL011
71-73	C-4, 302, steel	MOL008
71-73	C-4, 302, stainless	MOL008S
71-73	C-6, 351C, steel	MOL009
71-73	C-6, 351C, stainless	MOL009S
71-73	FMX, stainless	MOL011S

TRANSMISSION OIL COOLER FITTING



Brass fitting which screws into radiator oil cooler.

Transmission Oil Cooler Fitting

67-73	MOCF01
-------	-------	--------

TRANSMISSION OIL COOLER HOSE KIT



Connects transmission oil cooler lines to transmission oil cooler in radiator. Includes hoses, fittings and post clamps.

Transmission Oil Cooler Hose Kit

64-65	6 cyl. or 8 cyl.	MOC001
-------	-----------------------	--------

TRANSMISSION OIL LINE BRACKET



Mounts to front right hand side of engine, holds transmission cooler lines in place to prevent damage.

Transmission Oil Line Bracket

64-66	V8	MTLB01
-------	----------	--------

SHOP WITH CONFIDENCE! WE OFFER SUPERIOR-QUALITY PARTS FOR ALL YOUR MUSTANG RESTORATION NEEDS.

TRANSMISSION OIL LINE RETAINER CLIP

 These retainer clips were specially tooled up, not a generic clip. Holds transmission lines together. Made from spring steel, black oxide finish.
Transmission Oil Line Retainer Clip
 64-73LRC101

C-6 TRANSMISSION PAN

 Steel stamped construction.
Transmission Pan, C-6
 67-73 C-6, chrome w/ drain plugC7ZZ-7A194-A

CONCOURS C-4 TRANSMISSION PAN

Stamped steel construction.
Transmission Pan, Concours C-4

 64-73: C-4, chrome w/ drain plug
 C5ZZ-7A194-A

 64-73: C-4, chrome
 C5ZZ-7A194-C

 64-73: C-4, natural gray
 C5ZZ-7A194-S

DEEP C-4 TRANSMISSION PAN

Stamped steel construction. These are 1" deeper than stock depth. Improves cooling and looks great.
Transmission Pan, Deep C-4
 64-73 C-4, 1" deeper, chrome ... C5ZZ-7A194-CD
 64-73 C-4, 1" deeper, natural gray .. C5ZZ-7A194-SD

TRANSMISSION PLATES

AUTOMATIC TRANSMISSION FLEX PLATE

 All new, not rebuilt. Precision welded and balanced. Includes new ring gear.
Automatic Transmission Flex Plate
 64-72 C-4, 157 teeth, 289, 302 ... C3AZ-6375-L
 67-70 C-6, 184 teeth, 390C7AZ-6375-B
 68-70 428, non SCJ C8AZ-6375-C
 69-73 C-4 & FMX, 164 teeth, 302, 351W
 C9AZ-6375-A

AUTOMATIC TRANSMISSION INSPECTION PLATE

A nice reproduction of a commonly missing part. Helps keep dirt and debris out of the bell housing.
Automatic Transmission Inspection Plate

 64-73: C-4, zinc
 C5DZ-7986-B

 64-73: C-4, chrome
 C5DZ-7986-C

 66-70: C-6, black
 C6AZ-7986-A

AUTOMATIC TRANSMISSION SPACER PLATE

 Stamped steel spacer plate goes between engine and bell housing. Fits 157 teeth flywheels only.
Automatic Transmission Spacer Plate
 65-68 C-4, 289, 6 bolt C5ZZ-7007/7986

MANUAL TRANSMISSION SPACER PLATE

 Plate that is required to give proper spacing for flywheel and starter, also used to reinforce starter mounting.
Manual Transmission Spacer Plate
 64-65 SB, 5 boltC4DZ-7007-A
 65-68 289, 6 bolt, 157 teethC5DZ-7007-A
 68-73 302, 164 teethC9DZ-7007-A

TRANSMISSION SPACER PLATE CONVERSION KIT

 **Transmission Spacer Plate Conversion Kit**
 65-70 T-5V8, 6 bolt T5-PLATE-KIT6

VACUUM MODULATOR

 **VACCUUM MODULATOR**
 American made. Premium aftermarket brand.
Vacuum Modulator
 64-71 64-71 C-4, 66-72 C-6 C4AZ-7A377-B

VACCUUM MODULATOR LINE

 **Vacuum Modulator Line**
 64-65 C-4, V8, steelMVT002
 64-65 C-4, V8, stainless MVTO02S
 64-68 6 cyl., steelMVT003
 64-68 6 cyl., stainless MVT003S
 65-66 C-4, steelMVT001
 65-66 C-4, stainless MVTO01S
 67-69 C-4, V8, steelMVT004
 67-69 C-4, V8, stainless MVT004S
 68-69 C-6, V8, steelMVT007
 68-69 C-6, V8, stainless MVTO07S
 71-73 C-4, V8, steelMVT005
 71-73 C-4, V8, stainless MVTO05S
 71-73 C-6, 351, steelMVT006
 71-73 C-6, 351, stainless MVTO06S

TRUNK COMPARTMENT

BAGS

CONVERTIBLE TOP BOOT BAG

 Large envelope used to hold top boot, helps keep boot clean and damage free.
Convertible Top Boot Bag
 64-73 Speckled BB-FM-SPK

JACK BAG

 Organized way to keep the jack clean and help reduce quarter panel damage from jack hitting the interior.
Jack Bag
 64-70 Plaid, matches heavy duty ... JB-PLD-HD
 64-73 BlackJB-FM-BK
 64-73 Plaid (matches std. duty) JB-FM-PLD
 64-73 Speckled JB-FM-SPK

JUMPER CABLE BAG

 Nice storage device to hold jumper cables, protects cables and trunk interior. Matches standard duty.
Jumper Cable Bag
 64-73 BlackBC-BK
 64-73 PlaidBC-PLD
 64-73 Speckled BC-SPK

LARGE LUGGAGE TOTE BAG

Heavy duty vinyl sewn storage bag. Carry handles with large zipper opening.

Available in all Black, Plaid or Speckled. Matches standard duty.

Luggage Tote Bag, Large

- 64-73 Black, w/ emblem * TB-FM-BK-E
- 64-73 Black, no emblem TB-L-BK-NE
- 64-73 Plaid, w/ emblem * TB-FM-L-PLD
- 64-73 Plaid, no emblem TB-L-PLD-NE
- 64-73 Speckled, w/ emblem * TB-FM-L-SPK
- 64-73 Speckled, no emblem TB-L-SPK-NE

SMALL LUGGAGE TOTE BAG

There is a full line of Trunk accessories to match our trunk mats. All made with the same high

quality material in the U.S. Check out our tire covers, tote bags and booster cable bag. Bag dimensions 8 Inch x 17 Inch

Luggage Tote Bag, Small

- 64-73 Black, w/ emblem * TB-FM-BK-ES
- 64-73 Black, no emblem TB-S-BK-NE
- 64-73 Plaid, w/ emblem * TB-FM-S-PLD
- 64-73 Plaid, no emblem TB-S-PLD-NE
- 64-73 Speckled, w/ emblem * TB-FM-S-SPK
- 64-73 Speckled, no emblem TB-S-SPK-NE

TOOL KIT BAG

Vinyl storage for common emergency tools, inside has felt lining. Matches standard duty.

Tool Kit Bag

- 64-73 Plaid TK-FM-PLD
- 64-73 Speckled TK-FM-SPK

FILLER BOARDS**TAIL LIGHT FILLER BOARD**

Fits into the trunk compartment and protects the tail lamp housings. Made from original type black oil paper board.

Tail Light Filler Board

- 68 Shelby & California Special S8MS-65403A25-A
- 69-70 Shelby S9MS-65403A25-A

TRUNK FILLER BOARD

Mounts in left side of trunk to cover the hole between the quarter panel skin and the trunk floor. Made of heavy duty fiberboard or black chipboard.

Trunk Filler Board

-  64-66: Fiber board
C5Z-6511228-A
-  67-68: Black chipboard
C7Z-6511228-A
-  69-70: Black chipboard
C9Z-6511228-A

GLOVE BOX & TRUNK LOCKS**GLOVE BOX AND TRUNK LOCK**

This kit allows the use of one key for the glovebox and trunk lock.

Glove Box and Trunk Lock

- 67-68 C6DZ-6506072-K
- 69-70 C9Z-6506072-K

LUG NUT WRENCH**LUG WRENCH**

A great lug wrench. Provides 200% more torque than a standard wrench. complete with 4 socket sizes to fit just about any lug nut. Makes a perfect gift.

Lug Wrench

- 64-73 ACC-1721

PADS**SPARE TIRE JACK PAD**

This extra thick felt pad protects rim from scratches and eliminates rattles caused by the jack.

Spare Tire Jack Pad

- 69-73 C9Z-17A092-A

REAR SEAT DIVIDERS**REAR SEAT DIVIDER**

Separates the interior from the trunk space. Mounts behind the rear seat back rest. Reduces

noise and insulates the interior from trunk heat.

Rear Seat Divider

- 64-66 CP & CV C5Z-6545728
- 67-68 CP, gray felt C7Z-6545728
- 67-68 CV C7Z-7645728

SPARE TIRE MOUNTING**SPACE SAVER MOUNTING BRACKET**

Kit that allows mounting a space saver tire in the trunk.

Space Saver Mounting Bracket

- 69-70 C9Z-1424-K

SPARE TIRE HOLD DOWN PLATE

Mounting plate for your spare tire securely.

Spare Tire Hold Down Plate

- 64-67: Black, std. wheels
C5Z-1424-A



- 64-67: Black, styled steel wheels
C5Z-1424-B



- 64-67: Chrome, styled steel wheels
C5Z-1424-C

SPARE TIRE MOUNTING BOLT

Exact copies of the bolts used by Ford. Zinc plated.

Spare Tire Mounting Bolt

- 64-65: Carriage bolt
C5Z-1448-B



- 65-67: Hook bolt
C60Z-1448-A



- 69-73: Hook bolt, 1/2" - 13 x 10
3/4" long
C9Z-1448-B

SPARE TIRE MOUNTING KIT

Complete hardware kit to replace the factory mounting pieces. Includes correct cadmium plated wing nut, zinc plated mounting bolt, and painted hold-down plate with correct tabs. Exact reproductions of the originals.

Spare Tire Mounting Kit



64-65: Carriage bolt
C4Z-14244862-K

65-67: Hook bolt
C5ZZ-14244862-K

SPARE TIRE WING NUT



Spare tire wingnut. Nice copies of the originals. Finished either zinc plated or in polished 304

stainless steel for extra corrosion protection.

Spare Tire Wing Nut

64-67 ZincB9AZ-1462-A
68-73 ZincC8AZ-1462-B

TRUNK CARPET

TRUNK CARPET KIT



This kit includes everything to carpet the entire trunk area and is made of 100% nylon. All edges are bound to keep the carpet from

fraying. The side panels are made with fiberboard to make a clean professional installation.

Trunk Carpet Kit

65-66 CP, blackTMK-CP-65-BK
65-66 FB, blackTMK-FB-65-BK
67-68 CP, blackTMK-CP-67-BK
67-68 FB, blackTMK-FB-67-BK
69-70 FB, blackTMK-FB-69-BK

TRUNK MATS & SPARE TIRE COVERS

HEAVY DUTY SPARE TIRE COVER



Available in Plaid or Speckled patterns. Specially manufactured to match patterns on the "Heavy Duty

Trunk Mat". Thick vinyl construction.

Heavy Duty Spare Tire Cover

64-70 Plaid, 14"TC-PLD-14
64-70 Plaid, 15"TC-PLD-15
64-70 Speckled, 14"TC-SPK-14
64-70 Speckled, 15"TC-SPK-15

HEAVY DUTY TRUNK MAT



Incredibly tough rubber-like mats made to our specifications. Just like the original

Ford mats. Much more durable than felt-backed vinyl mats. Formed to fit trunk floor. Fits coupes and convertibles with no trimming. Fastback installations require slight trimming.

Heavy Duty Trunk Mat

64-66 PlaidC5ZZ-6545456CAB
65-68 PlaidC7ZZ-6545456CAB
69-70 SpeckledC9ZZ-6545456CAB
71-73 Plaid, heavy dutyD1ZZ-6545456CAB

STANDARD DUTY SPARE TIRE COVER



Available in Black, Plaid or Speckled. Sewn vinyl construction.

Standard Duty Spare Tire Cover

64-73 Black, 14"TC-BLK-14V
64-73 Black, 15"TC-BLK-15V
69-73 Space saver, blackTC-BLK-SS
64-73 Plaid, 13"TC-PLD-13V
64-73 Plaid, 14"TC-PLD-14V
64-73 Plaid, 15"TC-PLD-15V
64-73 Speckled, 13"TC-SPK-13V
64-73 Speckled, 14"TC-SPK-14V
64-73 Speckled, 15"TC-SPK-15V

STANDARD DUTY TRUNK MAT



These precision cut mats are manufactured in the U.S. using the most correct material available. They fit

perfectly. In addition, they are printed with the correct plaid or speckle print. Felt backed.

Standard Duty Trunk Mat

65-66 CP & CV, plaidTM-FM-CPCV-65P
65-66 CP & CV, speckledTM-FM-CPCV-65-S
65-66 FB, plaidTM-FM-FB-65-P
65-66 FB, speckledTM-FM-FB-65-S
67-68 CP & CV, plaidTM-FM-CPCV-67P
67-68 CP & CV, speckledTM-FM-CPCV-67-S
67-68 FB, plaidTM-FM-FB-67-P
67-68 FB, speckledTM-FM-FB-67-S
69-70 CP & CV, plaidTM-FM-CPCV-69P
69-70 CP & CV, speckledTM-FM-CPCV-69-S
69-70 FB, plaidTM-FM-FB-69-P
69-70 FB, speckledTM-FM-FB-69-S
71-73 CP & CV, plaidTM-FM-CPCV-71P
71-73 CP & CV, speckledTM-FM-CPCV-71-S
71-73 FB, plaidTM-FM-FB-71-P
71-73 FB, speckledTM-FM-FB-71-S

BURTEX TRUNK MAT



Original type construction Burtex. We found the best Burtex manufacturer in the country. Excellent fit.

Trunk Mat, Burtex

64-68 CP & CV, speckledC5ZZ-6545456-B
65-67 FB, speckledC5ZZ-6345456-B
67 FB, plaidC7ZZ-6345456-B
67 CP & CV, plaidC7ZZ-6545456-B
68 FB, speckledC8ZZ-6345456-B
69-70 CP & CV, speckledC9ZZ-6545456-B
71-73 FB, speckledD1ZZ-6345456-B

TRUNK RELEASES

TRUNK RELEASE



High quality chrome with improved cable. Includes chrome base, lever cable, and all mounting hardware. (Note: 67-70

release only works on cars that come factory equipped with this option. All others refer to electronic version)

Trunk Release

64-66 AllC4AZ-62432A00-A
67-70 Manual remoteC7AZ-62432A00-A

ELECTRONIC TRUNK RELEASE



We combined the classic look of the original remote trunk release with a chrome release lever

and a strong electric solenoid driven latch with a modern micro switch release. Now, with a light finger pull the trunk lid opens. No cables to stretch or corrode. Simple 30 minute installation with no modifications to the car.

All mounting hardware and connectors are included. Fits Coupe, Fastback and Convertible.

Trunk Release, Electronic

64-66C5AZ-6243200-EL
67-70C7AZ-6243200-EL

WIRELESS TRUNK RELEASE



This is an upgrade to our Electronic Trunk Release. Allows trunk to be opened with just the push of a button on

two wireless remotes that are included.

Trunk release, wireless

64-70C5ZZ-6243200-WR

WE PROUDLY FEATURE AUTHENTIC MUSTANG REPRODUCTIONS FROM SCOTT DRAKE ENTERPRISES!



TRUNK UNDERLAYMENTS

TRUNK UNDERLAYMENT



Installs over fuel tank and under trunk mat. Helps to reduce trunk noise and

protect top of fuel tank. Thick rubber material.
Trunk Underlayment
 65-68 TrunkUL-5

WHEELS

BEARINGS AND RACES

BRAKE HUB GREASE CAP



Stamped steel with gold dichromate finish.

Brake Hub Grease Cap

64-66 6 cyl.C3DZ-1131-A
 64-69 8 cyl.B5A-1131-A

FRONT WHEEL BEARING AND RACE



U.S. made quality bearings.

Front Wheel Bearing and Race

64-66 Inner, 6 cyl., drum C5ZZ-1201-A
 64-66 Outer, 6 cyl., drum C5ZZ-1216-A
 64-69 Inner, V8 B5A-1201-A
 64-69 Outer, V8 B5A-1216-A
 69 Inner, Boss, disc C9ZZ-1201-A
 69 Outer, Boss, disc C9ZZ-1216-A
 70-73 Inner DOZZ-1201-A
 70-73 Outer DOZZ-1216-A

REAR WHEEL BEARING



High quality part made in the U.S.A.

Rear Wheel Bearing

64-73 V8, 8 & 9" rear end, 28 spline ...C5ZZ-1225-A
 65-70 6 cyl., 24 spline C5ZZ-1225-B

LUG NUTS AND WRENCHES

LUG NUT

Multiple styles of lugnuts are available to finish off the look of your wheels.

Lug Nut



64-73: std.
 COAZ-1012-A



65-67: Styled steel, show quality, chrome
 CSZZ-1012-A



69-73: Magnum 500, Show quality, chrome
 C9ZZ-1012-B

LUG WRENCH

A great lug wrench. Provides 200% more torque than a standard wrench. complete with 4 socket sizes to fit just about any lug nut. Makes a perfect gift.



Lug Wrench

64-73ACC-1721

WHEEL LOCK

Protect your expensive rims and tires from theft. Our locks are made to resemble factory lugnuts for a cleaner appearance. This kit includes four chrome, keyed lugnuts and matching key.



Wheel Lock

64-73 C5ZZ-1012-LOCK

SEALS, SPACERS, & VALVE STEMS

FRONT WHEEL GREASE SEAL



Made in the U.S. to ensure high quality and reliability.

Wheel Grease Seal, Front

64-70 V8B5AZ-1190-A
 65-66 6 cyl., drum C5ZZ-1190-A
 69 Boss disc C9ZZ-1190-A

REAR AXLE WHEEL SEAL



Made in the U.S. to ensure high quality and reliability.

Wheel Seal, Rear Axle

64-66 V8, 8" rear end, 28 splineC5ZZ-1177-A
 64-66 6 cyl. C5ZZ-1177-B
 65-73 9" rear end, 31 spline C5ZZ-1177-C
 67-70 6 cyl.C7ZZ-1177-B
 67-73 V8, 8 & 9" rear end, 28 splineC7ZZ-1177-A

WHEEL SPACER



Aluminum spacer to offset custom wheels. This hard to find thin spacer is sometimes required to clear upper control arm when

running oversized tires on our style steel rim.

Wheel Spacer

65-73 1/8" thickSP601-5

WHEEL

CLASSIC WHEEL



These Rims look great and are period correct for any Mustang or Classic Ford. Cast in high grade aerospace aluminum.

Designed and tested to

meet DOT and SFI racing requirements. Check out our billet hub caps for a great add on.

Wheel, Classic

65-73 15" x 7" S1MS-1007-A

COBRA-STYLE WHEEL



These wheels are real head turners. Available in all chrome or polished with charcoal inserts to match your vehicle. 4

1/2" backspacing. Lugnuts sold separately.

Wheel, Cobra-style

65-73 Chrome, 17" x 8" R-1007-340C
 65-73 Charcoal, 17" x 8" R-1007-340SC

MAGNUM 500 WHEEL



Does not include center cap.

Wheel, Magnum 500

69 14" x 7", 2" center hole C9ZZ-1007-A
 69 15" x 7", 2" center hole C9ZZ-1007-B
 69-73 14" by 7", 2 1/8" center hole D1ZZ-1007-B
 69-73 15" x 7", 2 1/8" center hole . D1ZZ-1007-A
 69-73 15" x 8", 2 1/8" center hole . D1ZZ-1007-C



Wheel, Styled Steel

65	14" x 5", chrome, charcoal inner ...	CSZZ-1007-A
64	14" x 5", chrome, argent inner .	CSZZ-1007-ARG
65-67	14" x 6", chrome	CSZZ-1007-D
65-67	14" x 7", chrome	CSZZ-1007-B
65-67	15" x 7", chrome	CSZZ-1007-C
66	14" x 5", black rim	C6ZZ-1007-A
67	14" x 5 1/2", black rim	C7ZZ-1007-A
68-69	14" x 6", black rim	C80Z-1007-A
68-69	14" x 6", chrome	C80Z-1007-B
68-69	14" x 7", chrome	C80Z-1007-C

Our Styled Steel wheels are the best on the market.

- Features include:**
- Precise assembly to ensure a true and balanceable rim
 - Triple chrome plating
 - Attractive and informative double wall shipping boxes
 - Correct charcoal painted recesses baked on for durability
 - Simulated rivets on stock sizes for concours judging
 - Correct clearance for original 1965-67 4 piston disc brake calipers

10-SPOKE WHEEL

17" Shelby 10-Spoke Wheels for early Mustangs! These wheels feature cast and machined-textured surfaces, which provide a beautiful contrast under a clear-coat, protective finish. Aftermarket center caps included.

Wheel, Shelby-style

	64-73: 17" x 8" S2MS-1007-17
	64-73: 15" x 7" S7MS-1007-A

VINTAGE 50 WHEEL

Vintage 50 wheels feature media blasted/machine, 10 spoke design. This line of classic alloy wheels are engineered & designed with yesteryear's performance car in mind.

Wheel, Vintage 50

64-73	16" x 8"	V50-16X8
-------	----------------	----------

VINTAGE 40 WHEEL

Vintage 40 wheels feature media blasted/machine, straight spokes. This line of classic alloy wheels are engineered & designed with yesteryear's performance car in mind.

Wheel, Vintage 40

64-73	16" x 8"	V40-16X8
64-73	17" x 7"	V40-17X7
64-73	17" x 8"	V40-17X8

VINTAGE 45 WHEEL

Vintage 45 wheels feature media blasted/machine, curved spokes. This line of classic alloy wheels are engineered & designed with yesteryear's performance car in mind.

Wheel, Vintage 45

64-73	16" x 8"	V45-16X8
64-73	17" x 7"	V45-17X7
64-73	17" x 8"	V45-17X8

VINTAGE 48 WHEEL

Vintage 48 wheels feature media blasted/machine, spokes. This line of classic alloy wheels are engineered & designed with yesteryear's performance car in mind.

Wheel, Vintage 48

64-73	16" x 8"	V48-16X8
-------	----------------	----------



WHEEL ACCENTS

STYLED STEEL WHEEL ACCENT



Features include a bright-chrome finish and simple snap-in installation. These were a rare option offered by Ford. These wheel accents really dress up argent or body-color painted rims! 50 piece set does 4 wheels.

Styled Steel Wheel Accent

68-69	C9Z-1A079-A
-------	-------	-------------

WHEEL HUB CAPS, COVERS, & BEAUTY RINGS

BILLET HUB CAP

High quality billet to give your Torq Thruster or Vintage wheels a finishing touch.



Hub Cap, Billet

64-73	Cobra logo, Torq Thrust D wheel, set of 4 *s	B-1130-COBRA-T
64-73	Cobra logo, vintage wheel, set of 4 *s	B-1130-COBRA-V
64-73	GT logo, Torq Thrust D wheel, set of 4	B-1130-GT-T
64-73	GT logo, vintage wheel, set of 4	B-1130-GT-V
64-73	Horse logo, Torq Thrust D wheel, set of 4 *	B-1130-H-T
64-73	Horse logo, vintage wheel, set of 4 *	B-1130-H-V
64-73	No logo, Torq Thrust D wheel, set of 4	B-1130-P-T
64-73	No logo, vintage wheel, set of 4	B-1130-P-V

SHELBY HUB CAP



Our hub caps feature perfect detail and the correct red accent color. Our design is time tested and guaranteed not to separate from the wheel while driving.
Hub Cap, Shelby



65-66: G.T.350 cobra logo[§]
S2MS-1130-B



66-67: CS logo, fits 10 spoke Shelby wheel[§]
S2MS-1130-C



69-70: Cobra logo[§]
S9MS-1130-D

MAGNUM HUB CAP



These beautiful hub caps feature our high quality chrome bezels. Designed to fit Magnum 500 wheels.
Magnum Hub Cap



69: Fits 2" center hole*
C9Z-1130-E



69-70: 2 1/8" hole, 0.66" tall*
D0ZZ-1130-A



69-73: Spinner*
D1ZZ-1141-A



71-73: Fits 2 1/8" hole, 1" tall*
D1ZZ-1130-GR

KNOCK OFF HUB CAP

Die cast construction with show car chrome.
Knock Off Hub Cap



65
CSZZ-1141-A



66
C6ZZ-1141-A

KNOCK OFF HUB CAP EMBLEM



These are the center emblems for our knock off hub caps.

Knock Off Hub Cap Emblem



65: Spinner, std.*
CSZZ-1141-E



66: Spinner, std.*
C6ZZ-1141-E

STYLED STEEL HUB CAP



Our hub caps feature perfect detail and the correct accent color. Our design is time tested and guaranteed not to separate from the wheel while driving.
Styled Steel Hub Cap



65-66: Black*
CSZZ-1130-BK

65-66: Black, set of 4*
CSZZ-1130-WB

65-66: Blue*
CSZZ-1130-BL

65-66: Blue, set of 4*
CSZZ-1130-WBL

65-66: Red*
CSZZ-1130-W

65-66: Red, set of 4*
CSZZ-1130-WR



67: Black*
C7ZZ-1130-B

67: Black, set of 4*
C7ZZ-1130-BK

67: Blue*
C7ZZ-1130-A

67: Blue, set of 4*
C7ZZ-1130-AK

67: Red*
C7ZZ-1130-R

67: Red, set of 4*
C7ZZ-1130-RK



68-69: GT*
C80Z-1130-C



68-69: Plain, no logo*
C80Z-1130-G

STYLED STEEL HUB CAP EMBLEM

Styled Steel Hub Cap Emblem



68-69: "GT"
C80Z-1141-A

STYLED STEEL WHEEL COVER



Gives the illusion of real styled steel wheels at one third of the price. Constructed from heavy duty A.B.S. plastic. Also features correct charcoal

painted recessed areas and chrome simulated lugnuts. Now even 6 cylinders can have an 8 cylinder look. Center cap not included.

Styled Steel Wheel Cover

64-67 14", set of 4 CSZZ-1007-HCS
65-67 14" CSZZ-1007-HC

STYLED STEEL WHEEL COVER HUB CAP



These caps are gorgeous. Designed to fit our plastic styled steel wheel covers.

Styled Steel Wheel Cover Hub Cap

64-66 Black, set of 4* CSZZ-1130-BKL
65-66 Red, each* CSZZ-1130-WL

WHEEL BEAUTY RING



Great reproductions of the original parts. Polished stainless steel.

Wheel Beauty Ring

66 orig. style C6ZZ-1210-AR
66 orig. style, set of 4 C6ZZ-1210-AS
67 orig. style C7ZZ-1210-AR
67 orig. style, set of 4 C7ZZ-1210-AS

WHEEL COVER

Stock replacement wheel covers. **Center emblem not included.**
Wheel Cover



65: 14"
CSZZ-1130-J



66: 14"
C6ZZ-1130-A

WHEEL COVER EMBLEM



Fits our standard wheel covers.

Wheel Cover Emblem



65*
CSZZ-11C30



66*
C6ZZ-11C30

WIRE SPOKE WHEEL COVER



Spinner and emblem sold separately.

Wire Spoke Wheel Cover

65-67CSAZ-1130

WIRE SPOKE CENTER CAP



Fits wire spoked wheel covers.

Wire Spoke Center Cap

65-66 Spinner, blue*CSAZ-1141-A

WINDOWS

WINDSHIELD GLASS



WINDSHIELD GLASS

Nice replacement windshields without Ford logos.

Windshield Glass

65-68 All, clearC6ZZ-6503100-C
65-68 All, tintedC6ZZ-6503100-T
69-70 FB, clearC9ZZ-6503100-C
69-70 FB, tintedC9ZZ-6503100-T

VENT GLASS



VENT GLASS

Vent glass is available in clear, factory green tinted, or a new "smoke" version which resembles a modern black tint. Fits convertible, coupe, and Fastback.

Vent Glass

64-68 RH, clearC5ZZ-6521412-C
64-68 RH, smokeC5ZZ-6521412-S
64-68 RH, tintedC5ZZ-6521412-T
64-68 LH, clearC5ZZ-6521413-C
64-68 LH, smokeC5ZZ-6521413-S
64-68 LH, tintedC5ZZ-6521413-T

DOOR GLASS

DOOR GLASS ASSEMBLY



This door glass includes the frame, glass run and mounting bracket. Available in clear glass only.

Door Glass Assembly

67-68 FB, LHC7ZZ-6321410-KL
67-68 FB, RHC7ZZ-6321410-KR
67-68 CP, LHC7ZZ-6521410-KL
67-68 CP, RHC7ZZ-6521410-KR
67-68 CV, LHC7ZZ-7621410-KL
67-68 CV, RHC7ZZ-7621410-KR



CONVERTIBLE DOOR GLASS

Convertible door glass is available in clear, factory green tinted, or a new "smoke" version which resembles a modern black tint. Glass only.

Door Glass, Convertible

64-66 RH, clearC5ZZ-7621410-C
64-66 RH, smokeC5ZZ-7621410-S
64-66 RH, tintedC5ZZ-7621410-T
64-66 LH, clearC5ZZ-7621411-C
64-66 LH, smokeC5ZZ-7621411-S
64-66 LH, tintedC5ZZ-7621411-T
67-68 RH, clearC7ZZ-7621410-C
67-68 RH, smokeC7ZZ-7621410-S
67-68 RH, tintedC7ZZ-7621410-T
67-68 LH, clearC7ZZ-7621411-C
67-68 LH, smokeC7ZZ-7621411-S
67-68 LH, tintedC7ZZ-7621411-T
70 Clear, RHD0ZZ-7621410-C
70 Tinted, RHD0ZZ-7621410-T
70 Tinted, LHD0ZZ-7621411-T

COUPE DOOR GLASS

Coupe door glass is available in clear, factory green tinted, or a new "smoke" version which resembles a modern black tint. Glass only.

Door Glass, Coupe

64-66 RH, clearC5ZZ-6521410-C
64-66 RH, smokeC5ZZ-6521410-S
64-66 RH, tintedC5ZZ-6521410-T
64-66 LH, clearC5ZZ-6521411-C
64-66 LH, smokeC5ZZ-6521411-S
64-66 LH, tintedC5ZZ-6521411-T
67-68 RH, clearC7ZZ-6521410-C
67-68 RH, smokeC7ZZ-6521410-S
67-68 RH, tintedC7ZZ-6521410-T

Door Glass, Coupe

67-68 LH, clearC7ZZ-6521411-C
67-68 LH, smokeC7ZZ-6521411-S
67-68 LH, tintedC7ZZ-6521411-T
69 RH, clearC9ZZ-6521410-C
69 RH, smokeC9ZZ-6521410-S
69 RH, tintedC9ZZ-6521410-T
69 LH, clearC9ZZ-6521411-C
69 LH, smokeC9ZZ-6521411-S
69 LH, tintedC9ZZ-6521411-T
70 RH, clearD0ZZ-6521410-C
70 RH, smokeD0ZZ-6521410-S
70 RH, tintedD0ZZ-6521410-T
70 LH, clearD0ZZ-6521411-C
70 LH, smokeD0ZZ-6521411-S
70 LH, tintedD0ZZ-6521411-T

FASTBACK DOOR GLASS

Fastback door glass is available in clear, factory green tinted, or a new "smoke" version which resembles a modern black tint. Glass only.

Door Glass, Fastback

65-66 RH, clearC5ZZ-6321410-C
65-66 RH, smokeC5ZZ-6321410-S
65-66 RH, tintedC5ZZ-6321410-T
65-66 LH, clearC5ZZ-6321411-C
65-66 LH, smokeC5ZZ-6321411-S
65-66 LH, tintedC5ZZ-6321411-T
67-68 RH, clearC7ZZ-6321410-C
67-68 RH, smokeC7ZZ-6321410-S
67-68 RH, tintedC7ZZ-6321410-T
67-68 LH, clearC7ZZ-6321411-C
67-68 LH, smokeC7ZZ-6321411-S
67-68 LH, tintedC7ZZ-6321411-T
69 RH, clearC9ZZ-6321410-C
69 RH, smokeC9ZZ-6321410-S
69 RH, tintedC9ZZ-6321410-T
69 LH, clearC9ZZ-6321411-C
69 LH, smokeC9ZZ-6321411-S
69 LH, tintedC9ZZ-6321411-T
70 RH, clearD0ZZ-6321410-C
70 RH, smokeD0ZZ-6321410-S
70 RH, tintedD0ZZ-6321410-T
70 LH, clearD0ZZ-6321411-C
70 LH, smokeD0ZZ-6321411-S
70 LH, tintedD0ZZ-6321411-T
71-73 RH, clearD1ZZ-6321410-C
71-73 RH, smokeD1ZZ-6321410-S
71-73 RH, tintedD1ZZ-6321410-T
71-73 LH, clearD1ZZ-6321411-C
71-73 LH, smokeD1ZZ-6321411-S
71-73 LH, tintedD1ZZ-6321411-T

WE PROUDLY FEATURE AUTHENTIC MUSTANG REPRODUCTIONS FROM SCOTT DRAKE ENTERPRISES!



QUARTER GLASS



CONVERTIBLE QUARTER GLASS

Convertible quarter glass is available in clear, factory green tinted, or a new "smoke" version which resembles a modern black tint.

Quarter Glass, Convertible

64-66	RH, clear	C5Z-7629710-C
64-66	RH, smoke	C5Z-7629710-S
64-66	RH, tinted	C5Z-7629710-T
64-66	LH, clear	C5Z-7629711-C
64-66	LH, smoke	C5Z-7629711-S
64-66	LH, tinted	C5Z-7629711-T
67-68	RH, clear	C7Z-7629710-C
67-68	RH, smoke	C7Z-7629710-S
67-68	RH, tinted	C7Z-7629710-T
67-68	LH, clear	C7Z-7629711-C
67-68	LH, smoke	C7Z-7629711-S
67-68	LH, tinted	C7Z-7629711-T
69	RH, clear	C9Z-6529710-C
69	RH, smoke	C9Z-6529710-S
69	RH, tinted	C9Z-6529710-T
69	LH, clear	C9Z-6529711-C
69	LH, smoke	C9Z-6529711-S
69	LH, tinted	C9Z-6529711-T
70	RH, clear	D0Z-6529710-C
70	RH, smoke	D0Z-6529710-S
70	RH, tinted	D0Z-6529710-T
70	LH, clear	D0Z-6529711-C
70	LH, smoke	D0Z-6529711-S
70	LH, tinted	D0Z-6529711-T

COUPE QUARTER GLASS

Coupe quarter glass is available in clear, factory green tinted, or a new "smoke" version which resembles a modern black tint.

Quarter Glass, Coupe

64-66	RH, clear	C5Z-6529710-C
64-66	RH, smoke	C5Z-6529710-S
64-66	RH, tinted	C5Z-6529710-T
64-66	LH, clear	C5Z-6529711-C
64-66	LH, smoke	C5Z-6529711-S
64-66	LH, tinted	C5Z-6529711-T
67-68	RH, clear	C7Z-6529710-C
67-68	RH, smoke	C7Z-6529710-S
67-68	RH, tinted	C7Z-6529710-T
67-68	LH, clear	C7Z-6529711-C
67-68	LH, smoke	C7Z-6529711-S
67-68	LH, tinted	C7Z-6529711-T
69	RH, clear	C9Z-6529710-C
69	RH, smoke	C9Z-6529710-S
69	RH, tinted	C9Z-6529710-T
69	LH, clear	C9Z-6529711-C
69	LH, smoke	C9Z-6529711-S

Quarter Glass, Coupe

69	LH, tinted	C9Z-6529711-T
70	RH, clear	D0Z-6529710-C
70	RH, smoke	D0Z-6529710-S
70	RH, tinted	D0Z-6529710-T
70	LH, clear	D0Z-6529711-C
70	LH, smoke	D0Z-6529711-S
70	LH, tinted	D0Z-6529711-T

FASTBACK QUARTER GLASS

Fastback quarter glass is available in clear, factory green tinted, or a new "smoke" version which resembles a modern black tint.

Quarter Glass, Fastback

69-70	RH, clear	C9Z-6329710-C
69-70	RH, smoke	C9Z-6329710-S
69-70	RH, tinted	C9Z-6329710-T
69-70	LH, clear	C9Z-6329711-C
69-70	LH, smoke	C9Z-6329711-S
69-70	LH, tinted	C9Z-6329711-T
69-70	RH & LH	C9Z-63302223
71-73	RH, clear	D1Z-6329710-C
71-73	RH, smoke	D1Z-6329710-S
71-73	RH, tinted	D1Z-6329710-T
71-73	LH, clear	D1Z-6329711-C
71-73	LH, smoke	D1Z-6329711-S
71-73	LH, tinted	D1Z-6329711-T

BACK GLASS



COUPE BACK GLASS

Coupe back glass is available in clear, factory green tinted, or a new "smoke" version which resembles a modern black tint.

Back Glass, Coupe

64-68	Clear	C5Z-6542006-C
64-68	Smoke	C5Z-6542006-S
64-68	Tinted	C5Z-6542006-T
69-70	Clear	C9Z-6542006-C
69-70	Smoke	C9Z-6542006-S
69-70	Tinted	C9Z-6542006-T

FASTBACK BACK GLASS

Fastback back glass is available in clear, factory green tinted, or a new "smoke" version which resembles a modern black tint.

Back Glass, Fastback

65-66	Clear	C5Z-6342006-C
65-66	Smoke	C5Z-6342006-S
65-66	Tinted	C5Z-6342006-T
67-68	Clear	C7Z-6342006-C
67-68	Smoke	C7Z-6342006-S
67-68	Tinted	C7Z-6342006-T
69-70	Clear	C9Z-6342006-C
69-70	Smoke	C9Z-6342006-S
69-70	Tinted	C9Z-6342006-T

WIPERS

WASHER COMPONENTS

FORD LICENSED WINDSHIELD WASHER BAG

* High quality rubberized vinyl bag, with silk screened FoMoCo logo. An exact copy of the original unit.

Windshield Washer Bag, Ford Licensed



64-65: White FoMoCo, twist cap*
C1AZ-17618-EA



66: White FoMoCo, flip cap*
C1AZ-17618-E



66-67: Gold FoMoCo, flip cap*
C1AZ-17618-D

WINDSHIELD WASHER HOSE CONNECTOR



Injection molded high strength plastic connector for hoses leading to nozzles. Just like the factory pieces.

Windshield Washer Hose Connector

64-66	COAB-17A601-A
67-70	C7SZ-17A601-A
71-73	D1ZZ-17A601-A

WINDSHIELD WASHER HOSE KIT



Made from high quality E.P.D.M. rubber with factory style ribbing along the length of each hose. Kits include

proper connector for each year. Hoses are cut to correct length.

Windshield Washer Hose Kit

64-66	C5Z-17601/5
67-68	C7ZZ-17601/5
69-70	C9Z-17601/5
71-73	D1ZZ-17601/5

SHOP WITH CONFIDENCE! WE OFFER SUPERIOR-QUALITY PARTS FOR ALL YOUR MUSTANG RESTORATION NEEDS.

**FORD LICENSED, COMPLETE
WINDSHIELD WASHER KIT**



Good looking and very complete. Kit includes washer bag, wiper hoses, wiper

nozzle's and windshield wiper spacer and nuts.
Windshield Washer Kit, Ford Licensed, Complete
 64-65 * KIT-WIP-1
 66 * KIT-WIP-2

WINDSHIELD WASHER NOZZLE

These are excellent reproductions of the original rubber-tipped and later metal-tipped nozzles. Bright cadmium finish for corrosion protection. Sold in pairs.
Windshield Washer Nozzle



64-65: Rubber tips
 C5Z-17603-D



66: Steel tips
 C5Z-17603-E



67-68: Steel tips
 C7Z-17603-A
 69:
 C9Z-17603-A
 70:
 D0Z-17603-A

WINDSHIELD WASHER NOZZLE TIP



Molded rubber replacement tips.

Windshield Washer Nozzle Tip
 64-65 Rubber C5AZ-17A602-B

WINDSHIELD WASHER PUMP

Original style washer pumps made to last.
Windshield Washer Pump



64-65: 1 speed
 C4AZ-17664-A



65-66: 2 speed
 C5AZ-17664-A



69-73: 2 speed
 E0AZ-17664-A

WINDSHIELD WASHER PUMP HARNESS



Supplies power to washer pump.

Windshield Washer Pump Harness
 64-65 C5Z-17290-A
 66 1 speed C6Z-17290-A1
 66 2 speed C6Z-17290-A2

**FORD LICENSED WINDSHIELD
WASHER RESERVOIR**



Blow Molded Plastic Features Exact Detail With FoMoCo logo.

Windshield Washer Reservoir, Ford Licensed



67-68 *
 C7OZ-17618-A



69-70: Reservoir*
 C9Z-17618-A

**WINDSHIELD WASHER RESERVOIR
BRACKET**



Stamped steel, painted black enamel.

Windshield Washer Reservoir Bracket
 64-66 C4AZ-17651-A

WINDSHIELD WASHER RESERVOIR CAP



This stamped aluminum cap secures tightly unlike the original and it looks great.

Windshield Washer Reservoir Cap
 64-65 C1AZ-17618-CAP

WIPER COMPONENTS

EXTERNAL WIPER BEZEL NUT TOOL



Specially designed for removing or installing bezel nuts, without risk of scratching or damaging bezel or paint.

External Wiper Bezel Nut Tool
 64-65 T-120

WINDSHIELD WIPER BEZEL & NUT KIT



These are perfect reproductions of the originals. Bezels are pressure cast in zinc and then finely chrome plated. Nuts are chromed plated brass. Sold in sets with two bezels and two nuts.

Windshield Wiper Bezel and Nut Kit
 64-65 C5Z-17514-K

WINDSHIELD WIPER ARM



Excellent reproductions of the originals, with stainless steel arm construction.

Windshield Wiper Arm
 64-65 Smooth end cap C1SZ-17526-A
 66-70 Flanged end cap C1SZ-17526-B

**WINDSHIELD WIPER ARM AND
BLADE KIT**



A convenient kit which makes sales easy. Each kit contains two wiper arms and two blade assemblies. Buy the kit and save.

Windshield Wiper Arm and Blade Kit
 64-65 stainless KIT-WIP-5
 66-68 stainless KIT-WIP-6

**WINDSHIELD WIPER BLADE
ASSEMBLY**



Good quality Trico Assembly. Stainless steel construction. Includes one wiper

blade assembly and one rubber blade.
Windshield Wiper Blade Assembly
 65-68 15" length C3AZ-17528-J
 69-70 16" length C9AZ-17528-A
 71-73 18" length D1Z-17528-A

WINDSHIELD WIPER BLADE REFILL



Quality name brand replacement blades. Made in the U.S.A. by Trico.

Windshield Wiper Blade Refill
 64-68 15" length C3AZ-17593-C
 69-70 16" length C9AZ-17593-A
 71-73 18" length D1Z-17593-A

Wipers

**WE PROUDLY FEATURE AUTHENTIC MUSTANG
REPRODUCTIONS FROM SCOTT DRAKE ENTERPRISES!**



WINDSHIELD WIPER PIVOT SEAL



Wiper seals are high quality and reliable. Originals were leather.

Windshield Wiper Pivot Seal

- 64-66 Leather CSZZ-17A475-BL
- 64-70 Rubber/foam CSZZ-17A475-B
- 67-70 Leather C7ZZ-17A475-BL

WINDSHIELD WIPER SWITCH



Single speed wiper switch without wash pump.

Windshield Wiper Switch

- 64-65 1 speed CSZZ-17A553-B

VARIABLE WINDSHIELD WIPER SWITCH



Wiper switches for multiple applications.

Windshield Wiper Switch, Variable

- 64-66 1 speed w/ control for washer CSZZ-17A553-V1
- 64-66 Variable, 2 speed w/ control for washer .. CSZZ-17A553-V2
- 69-70 Variable speed w/ control for washer C9ZZ-17A553-V2
- 71-73 Variable D1ZZ-17A553-V2

WINDSHIELD WIPER SWITCH RETAINING NUT



This beautifully chromed nut holds the wiper switch into the dash. This nut is almost always damaged

from improper tools used for removal and installation. Made from original factory prints.

Windshield Wiper Switch Retaining Nut

- 65-66 C4DZ-17512-A

WIPER BEZEL STEM NUT TOOL



Special tool designed to insert into wiper bezel stem nut used for assembly or disassembly. Will not damage nut.

Wiper Bezel Stem Nut Tool

- 64-66 T-110

WIPER TRANSMISSION ARM



New trans arms for smooth, even motion.

Wiper Transmission Arm

- 65-66 CSZZ-17566/7-A
- 67-68 C7ZZ-17566/7-A

INDEX

Accelerator Cable	71	Control Valve to Cylinder Hose	152
Accelerator Linkage	71	Convertible Parts	20
Accelerator Pedal	71, 107, 138	Convertible Pillar Seal	23
Accelerator Pedal Assembly	71	Convertible Pump Motor And Resevior	21
Accelerator Pedal Mounting Screw	107	Convertible Quarter Panel Snap Kit	21
Accelerator Pedal Spring	72, 107	Convertible Sun Visor Bracket And Rod	22
Accessories	4	Convertible Tack Strip, Bulk	23
AC Vent	84	Convertible Top Boot	20
Air Cleaner	59	Convertible Top Boot Bag	20, 171
Air Cleaner To Snorkle Nut	78	Convertible Top Boot Molding	21 - 22
Air Cleaner Wing Nut	78	Convertible Top Boot Snap Kit	20
Air Conditioner Belt	63	Convertible Top Harness	20, 46
Air Conditioner Kits, Switches, & Related	84	Convertible Top Hydraulics	21
Air Vent Assembly	85	Convertible Top Latch	21
Air Vent Inlet Gasket, Left Hand	87	Convertible Top Pad	23
Alternator	53	Convertible Top Rear Window	22
Alternator Belt, Bracket, Fan, & Pulley	60	Convertible Top Seal Kit	23
Alternator Harness	53	Convertible Top Switch	20, 90
Alternator Terminal Cover	53	Convertible Top Switch Bezel Tool	134
Aluminum Liquid Line	85	Convertible Top Tension Cable	21
Antenna	9	Convertible Top To Switch Circuit Breaker	20
Antenna Base Grommet	9, 135	Cookies, Mustang	5
Antenna Lead Wire	9	Cooling System	23
Arm Rest Base	33	Counter Stool	5
Arm Rest Base To Door Panel Screw	83	Courtesy Light Bracket	105
Arm Rest Pads	34	Courtesy Light Harness	46
Arm Rest Pad To Base Screw Kit	83	Courtesy Light Switch	48
Arm Rest Plug	34	Cowl Brace To Cowl Hardware	160
Ash Tray, Dash	89	Cowl Cover	145
Ash Tray Bumpers	138	Cowl Grille Assembly	145
Ash Tray Recepticle, Quarter Panel	108	Cowl Panel	145
Audio & Electronics	9	Cowl To Hood Seal	139
Automatic Transmission Flex Plate	171	Cowl Vent Repair Panel	145
Automatic Transmission Inspection Plate	171	Custom Fiberglass Body Kit	142
Automatic Transmission Master Rebuild Kit	169	Custom Front Support Bracket	142
Automatic Transmission Shift Housing Plug	138	Dash Molding Clip Kit	96
Automatic Transmission Shift Kit	170	Dash Pad	97
Automatic Transmission Spacer Plate	171	Dash Panel	96 - 98
Axle Bumper	161	Dash Panel Emblem	57, 98
Axle U Bolt	159	Dash Panel Nut	83
Backing Plate Axle Gasket	164	Dash Panel Repair Plate	10, 98
Back Glass	178	Dash Spacer Bar	86
Back Up Light Housing	50	Dealer Invoice, Shelby	30
Back Up Light Lens	50	Decals & Striping	25 - 33
Back Up Light Lens Gasket	50, 135	Defroster Control Cable	87
Back Up Light Pigtail	51	Defroster Duct	87
Back Up Light Spacer	79	Defroster Hose	87
Back Up Light Switch	51	Differential Gasket	164
Basic Repaint Kit	135	Differential Rebuild Kit	164
Battery Apron Plate	145	Directional Light Lever	90
Battery Cable Kit	53	Discharge Hose	86
Battery Clamp Bolt Kit	53, 78	Disc Brake Conversion Kit	11 - 12
Battery Cover, Autolite	53	Disc Brake Proportioning Valve	15
Battery Fender Shield	53	Distributor	61
Battery Hold Down Clamp	53	Distributor Cap	61
Battery Tray	54	Distributor Primary Lead Pigtail	54
Bedding And Glazing Compound	134	Distributor Tune Up Kit	61
Bezel and Knob Kit, Dash	89	Distributor Vacuum Advance	61
Body Molding Kit	129	Dome Light Assembly, Housing, Lens	46, 105
Brakes	11	Doors Parts	33
Brake And Clutch Pedal Bushing	12	Door Access Plug	40
Brake and Clutch Pedal Pad	107, 138	Door And Quarter Seal Screw	40, 135-136
Brake And Clutch Pedal Support	12	Door Bumper	40
Brake And Fuel Line Clip Kit	14, 73	Door Courtesy Light Assembly, and Lens	37
Brake Distribution Block	14	Door Edge Guard	40
Brake Drum	13	Door Glass	177
Brake Dust Shield, Disc	12		
Brake Extension Lead	14		
Brake Hose	14		
Brake Hub Grease Cap	13, 174		
Brake Light Switch Adapter	14		
Brake Line Kit	14 - 17		
Brake Line Pressure Gauge Kit	15		
Brake Pads, Front Disc	12		
Brake Pedal	12		
Brake Pedal Pad	12, 107, 138		
Brake Pressure Switch	14		
Brake Spring And Hold Down Kit	13		
Brake Wheel Cylinder	15		
Build Sheet	30		
Bullet, Polished Aluminum	109		
Bumpers	18		
Bumper Body Pad, Rear	19		
Bumper Bolt	18		
Bumper Braces, Brackets, and Guards	19 - 20		
Bumper License Lamp	20		
Bumper Sticker	4		
Calipers	12		
Carburetor Adapters and Spacers	72		
Carburetor Mounting Nut	78		
Carpet Kit	91 - 92		
Car Cover	4		
CD Changer	10		
Choke Cable, Thermostat Shield, & Tube Kit	72		
Cigarette Lighter	89 - 90		
Clock (Accessories)	5		
Clock Feed Wire	45		
Clock Knob and Screw Set	96		
Clutch Anti-Rattle Spring	162		
Clutch Cable Kit	162		
Clutch Disk	162		
Clutch Equalizer Bar	163		
Clutch Fan Bolt	25, 78		
Clutch Fork	162		
Clutch Pedal	163		
Clutch Pedal Pad	107, 138, 163		
Clutch Pedal Repair Shaft	163		
Clutch Pedal Roller Bearing Rebuild Kit	164		
Clutch Rod	162		
Clutch Spring	163		
Coat Hook	105		
Coil	61		
Coil Spring	157 - 158		
Coin Tray	85		
Compressor Related	85		
Condenser Related	85		
Console	93 - 94		
Console Ash Tray Recepticle	94		
Console Harness Feed	45		
Console Insert	94		
Console Interior Harness	45, 95		
Console Lamp Lens	46, 95		
Console Mounting Bracket	95		
Console Pad	95		
Console Rear Light Assembly	46, 95		
Console Shifter Selector Rod	166		
Console Shift Plate	95		
Console Shift Side Seal	166		
Control Arm	158		
Control Panel Bezels and Lenses	90		

**WE PROUDLY FEATURE AUTHENTIC MUSTANG
REPRODUCTIONS FROM SCOTT DRAKE ENTERPRISES!**



Door Glass Assembly.....	42, 177	Engine To Firewall Ground Wire	54	Fuel Hose.....	73
Door Glass Bumper.....	42	Evaporator	86	Fuel Line.....	74
Door Glass Run Channel	41, 137	Exhaust Air Check Valve	67	Fuel Line Bracket.....	73
Door Grille Mounting Kit	79	Exhaust Bracket, Rear Upper	70	Fuel Line Grommet.....	73, 140
Door Handle	34 - 36	Exhaust Hanger.....	70	Fuel Pipe Hose Clamp	74
Door Handle & Window Crank Kit	35	Exhaust Headers	69	Fuel Pump	73
Door Handle Bezel	39	Exhaust Manifold.....	69	Fuel Pump Mounting Gasket	73
Door Handle Clip Remover	35, 134	Exhaust Pipe.....	70	Fuel Pump Mounting Kit.....	82
Door Handle Shaft Assembly	120	Exhaust Port Divider.....	70	Fuel System.....	71
Door Handle Spring Clip.....	35	Exhaust System	69	Fuel Tank.....	75
Door Hinge.....	36	Exhaust Tips.....	71	Fuel Tank Filler Kit.....	75
Door Hinge Mount Kit	40, 79	Expansion Valve	86	Fuel Transfer Line.....	74
Door Hinge Spring Compressor.....	134	Export Brace	160	Full Set Seat Upholstery	113 - 116
Door Latch	36	Export Brace Mounting Plate	160	Fuse Box Repair Kit.....	46
Door Latch Assembly.....	120	Exterior Trim Screw Kit.....	81	Gas Cap	75 - 76
Door Latch Lock Rod.....	120	External Wiper Bezel Nut Tool.....	134, 179	Gauges	102 - 103
Door Latch Reinforcement Kit	36	Factory Start Tubes	70	Gauge Pod, 1967 Under Dash.....	110
Door Latch Retainer Bushing	36, 120	Fan Blade, Shroud	25	Gear Box.....	154
Door Latch Rod Retainer.....	36, 120	Fastback Door Glass Molding	129	Gear Box Cover Seal.....	154
Door Latch Screw	36, 80	Fastback Seat Bumpers	139	Generator Belt	63
Door Latch Spring	36	Fender	143	Generator Splash Shield	140
Door Light Gasket	139	Fender Bolts.....	80	Glovebox Latch	121
Door Lock Cylinder Retainer.....	120	Fender Apron.....	145	Glovebox Striker Kit.....	121
Door Lock Knob	36, 120	Fender Cover.....	4	Glove Box	100
Door Lock Knob Grommet.....	37, 120	Fender Emblem.....	56	Glove Box and Trunk Lock	172
Door Lock Rod.....	37	Fender Extension Seal	135	Glove Box Door Bumpers	139
Door Panel	37 - 38	Filler Tube, Fuel.....	74	Glove Box Emblem.....	58, 101
Door Panel Clip	38	Firewall	145	Grant Steering Wheel.....	155
Door Panel Cup	38	Firewall Air Conditioner Hose Grommet.....	86	Grille.....	76 - 77
Door Panel Emblem.....	39, 57	Firewall Insulation Fasteners	83, 139	Grille Corral And Horse.....	77
Door Panel Insert.....	39	Firewall Insulator	151	Grille Emblem	57, 77
Door Panel Remover	134	Firewall Outer, Partial	145	Grille Molding And Trim	129
Door Pull.....	39	Firewall To Hood Bumper	140	Grille Mounting.....	81
Door Shaft Assembly.....	37	Flasher, Turn Signal	48	Grille Support Bracket	77
Door Shell, Complete.....	143	Floor Extension	141	Hardware	78
Door Sill Plate Screw	83	Floor Frame Support, Inner.....	141	Harmonic Damper	61
Door Skin.....	143	Floor Mat	92	Hat	5
Door Speaker Crossover Harness	46	Floor Pan.....	140 - 141	Headlight.....	44
Door Striker Assembly	120	Fog Light Bar	76	Headlight Adjusting Kit.....	81
Door Tag Plate	40	Fog Light Bulb, G.E.....	43	Headlight Assembly Gill Trim.....	4
Door To Window Seal, Front	40, 135	Fog Light Housing Assembly	43, 76	Headlight Assembly Hardware Kit	44
Door Watershield.....	40	Fog Light Housing Rim.....	43	Headlight Bucket Assembly	44, 143
Drain Hole Cover.....	147	Fog Light Switch	43	Headlight Dimmer Switch.....	44
Drip Rail Molding.....	129	Fog Light Switch Bezel Tool	134	Headlight Dimmer Switch Cover Pad.....	139
Driveline Safety Loop.....	164	Fog Light Switch Knob and Bezel	90	Headlight Door	44, 144
Drum Brake Hub	13	Fog Light Wiring	43 - 44	Headlight Door Retainer Clip Kit	81
Drum Brake Shoe.....	13	Fold Down Seat Carpet, Fastback	93	Headlight Door Screw Kit	81
Dryer, Filter.....	86	Fold Down Seat Latch, Fastback	99	Headlight Retaining Ring	44
Dryer Mounting Bracket	86	Fold Down Seat Molding, Fastback	99	Headlight Switch	44
EFI Wiring Harness Kit	54	Frame Patch, Convertible Inner.....	141	Headlight Switch Retaining Nut	45
Electrical & Lighting.....	43	Frame Rail.....	141 - 142	Headlight Wiring Harness.....	45
Electric Fan And Shroud Kit	25	Front Cross Member	145	Headliner.....	101 - 102
Electric Trunk Release Kit.....	122	Front Fender Extension Molding	129	Headliner Glue.....	102, 131
Emblem, Shelby Seat Belt Insert.....	31, 58	Front License Bracket.....	143	Headliner Insulation Pad	102
Emblem, Steering Wheel Hub.....	156	Front Seat Hinge Shaft Retainer Clip Set	111	Head Gasket	60
Emblems.....	55	Front Seat Only Upholstery	116 - 118	Head Pipe Hanger Bracket, 6 Cyl.....	71
Emblem Barrel Clip	80	Front Seat Washer	111	Head Rest	112
Emblem Kit	55	Front Spoiler.....	143	Heater & AC Control Knobs.....	87
Emergency Flasher Knob.....	90	Front Suspension Bumper.....	161	Heater & AC Vacuum Line Hose Kit	86
Engine.....	59	Front Valance	143	Heater Blower Motor.....	88
Engine Dress Up Kit	67	Front Valance Mounting Kit.....	81	Heater Box Assembly	88
Engine Gasket, Full Set	64	Front Wheel Bearing and Race	13, 174	Heater Cable Clamp Bracket Kit	79
Engine Gauge Feed Harness	54	Fuel Filler Flange Gasket.....	74	Heater Control Cable.....	88
Engine Master Fastener Kit	64, 78	Fuel Filler Hose	74	Heater Control Plate - Woodgrain	87, 96
Engine Mount.....	63	Fuel Filler Pipe To Trunk Floor Seal	74	Heater Control Valve	88
Engine Mount Bracket.....	63	Fuel Filter.....	73	Heater Core.....	88

Heater Dash Plate.....	87	Interior Dye, AccuMatch™.....	132	Outside Door Handle Pad.....	36
Heater Hose.....	88	Interior Fastener Kit.....	82	Outside Door Handle Pad.....	135
Heater Hose Clamp.....	79	Interior Paint, AccuMatch™.....	132	Outside Mirror.....	127 - 128
Heater Hose Plug, Firewall.....	89	Interior Parts & Upholstery.....	89	Overhead Console Assembly.....	47, 96
Heater Related.....	89	Interior Quarter Panel.....	99, 108	Overhead Map Light Switch.....	47
Heating & AC.....	84	Interior Trim Screw Kit.....	82	Owners Manual.....	127
Heavy Duty Spare Tire Cover.....	173	Jack Bag.....	171	Package Tray.....	110
Heavy Duty Trunk Mat.....	173	Jumpers Cable Bag.....	171	Paint.....	131 - 133
High Temperature Silicone.....	134	J Nut Fastener.....	82	Parking Brake Assembly.....	17
Hog Ring Kit.....	112	Key.....	122	Parking Brake Cable.....	17 - 18
Hood.....	146	Keys, Locks & Latches.....	120	Parking Brake Equalizer.....	18
Hood Bumper.....	140	Key Fob, Mustang.....	6	Parking Brake Handle.....	17, 98
Hood Hinge.....	146	Kickdown Lever.....	165	Parking Brake Lever Spring.....	18
Hood Hinge Mounting Kit.....	81, 146	Kick Down Cable.....	72	Parking Brake Pedal Pad.....	18, 108, 139
Hood Hinge Spring.....	146	Kick Panels.....	105	Parking Light Retainer.....	144
Hood Latch.....	146	Kick Panel Screw.....	83	Park Light Assembly.....	49
Hood Letters.....	57	Kick Panel Trim.....	105	Park Light Bezel.....	49
Hood Lock Bracket.....	122	Knock Off Hub Cap and Emblem.....	176	Park Light Lens.....	49
Hood Molding.....	129	Leaf Spring.....	159	Park Light Seal.....	50
Hood Pin Kit.....	121	LeCarra Steering Wheel.....	156	PCV Hose.....	67
Hood Plenum.....	59	License Plate Bumper.....	135	Pedal Car.....	5
Hood Prop Rod.....	147	License Plate Frame.....	4	Pedal Pivot Assembly.....	72
Hood Safety Latch.....	146	License Plate Insert.....	4	Pillar Molding.....	102
Hood Scoop.....	146	License Plate Light Lens.....	51	Pillar Post Pad.....	102
Hood Scoop Emblem.....	57	License Plate Light Lens Gasket.....	135	Pitman Arm.....	152
Hood Scoop Seal.....	135	License Plate Mounting Kit.....	82	Power Brake Booster And Master Cylinder.....	17
Hood Seal Retainer Clip.....	140	License Plate Nut Fastener.....	82	Power Brake Booster Vacuum Line.....	17
Hood Turn Signal Harness.....	45	License Plate Nut.....	49	Power Brake Conversion Kit.....	16
Hood Turn Signal Insert.....	146	Light Bulbs.....	49	Power Steering Adjuster Bracket.....	153
Hood Turn Signal Light Assembly.....	45	Liquid Line Hose Assembly.....	86	Power Steering Ball and Stud Repair Kit.....	152
Hood Turn Signal Light Gasket.....	135	Literature.....	123	Power Steering Belt.....	63
Hood Twist Lock.....	121	Lock Kits.....	121	Power Steering Control Valve.....	152
Horn, Electric.....	54	Lubricant.....	131	Power Steering Cylinder.....	152
Horn Pad.....	154	Luggage Rack.....	5	Power Steering Hose.....	152
Horn Ring Button.....	155	Luggage Tote Bag.....	172	Power Steering Pump.....	153
Horn Ring Retainer Screw.....	83	Lug Nut.....	174	Pressure Plate Bolt Set.....	83
Horn Switch.....	48, 155	Lug Wrench.....	172, 174	Primer.....	133
Horn Switch Trim Plate.....	155	Magnetic Sign, Mustang.....	5	Proportioning Valve Rebuild Kit.....	15
Hot Water Elbow, Bypass.....	89	Magnum Hub Cap.....	176	Push Rod, Master Cylinder Adjustable.....	17
Hub Cap.....	175 - 176	Manuals.....	123	Quarter Glass.....	178
Hub Trim, Steering Wheel.....	156	Manual Steering Adapter.....	153	Quarter Glass Pivot Rod Cover.....	108
Idler Arm.....	151	Manual Transmission Overhaul Kit.....	170	Quarter Panel, Lower Rear.....	147
Idler Bearing Repair Kit.....	86	Manual Transmission Spacer Plate.....	171	Quarter Panel.....	147
Idler Pulley And Bracket.....	86	Marker Light Lens Gasket.....	135	Quarter Panel Drain Plug.....	135
Ignition Bezel Tool.....	90, 134	Marker To Body Seal.....	50	Quarter Panel Emblem.....	57
Ignition Cylinder And Keys.....	120	Master Body Kit.....	80	Quarter Panel Extension.....	148
Ignition Switch.....	48	Master Chassis Kit.....	81	Quarter Panel Extension Seal.....	136
Ignition Switch Bezel.....	90, 120	Master Cylinder.....	15 - 16	Quarter Panel Grille Gasket.....	136
Ignition Switch Pigtail.....	48	Mirrors.....	127	Quarter Panel Light.....	47
Ignition Switch Retainer.....	48, 91, 121	Molded Kick Panel Speaker.....	10	Quarter Panel Ornament.....	129
Ignitor Conversion.....	62	Molding.....	129	Quarter Panel Reflector.....	50
Inside Rear View Mirror Bracket.....	127	Molding Hardware.....	82, 129	Quarter Panel Skin.....	147
Inside Rear View Mirror.....	127	Molding Remover.....	134	Quarter Panel Trim.....	108
Inside Rear View Mirror Adhesive.....	127, 131	Molding Retainer Clip.....	129	Quarter Panel Trim Cap.....	99
Instrument Bezel.....	103	Monte Carlo Bar.....	160	Quarter Panel Window Handle.....	100
Instrument Cluster Loom.....	46	Muffler.....	71	Quarter Trim, Fastback Interior.....	99
Instrument Lens.....	104	Numbers.....	125	Quarter Vent Louvers.....	147
Instrument Panel and Glove Box.....	104	Neutral Safety Switch.....	48, 165	Quarter Window Molding.....	130
Instrument Panel Circuit, Printed.....	46	Nose Bracket.....	144	Quarter Window Seal.....	137
Instrument Voltage Regulator.....	46	Oil Cap.....	65	Quarter Window To Body Seal.....	136
Insulated Package Tray.....	151	Oil Dip Stick, Engine.....	66	Quarter Window Trim.....	130
Insulated Seat Divider.....	151	Oil Drain Plug.....	66	Quarter Panel Light Lens, Fastback.....	47
Insulation.....	150	Oil Filter.....	66	Quick Disconnect Fitting.....	86
Intake Manifold.....	65	Oil Pan.....	66	Racing Mirror.....	128
Intake Manifold Bolt Kit.....	65, 79	Oil Pressure Extension Lead.....	54	Rack and Pinion Kit.....	153
Intake Manifold Gasket.....	65	Oil Pressure Sending Unit.....	54	Radiator.....	26
		Oil Pump.....	67		

**WE PROUDLY FEATURE AUTHENTIC MUSTANG
REPRODUCTIONS FROM SCOTT DRAKE ENTERPRISES!**



Radiator And Heater Hose Clamp Set.....	23	Seat Hinge Repair Bracket.....	112	Steering Wheel.....	156 - 157
Radiator Cap.....	25	Seat Latch Handle and Bezel Set.....	112	Steering Wheel Emblem.....	58
Radiator Coolant Filter.....	24	Seat Platform.....	141	Steering Wheel Horn Contact Plate.....	157
Radiator Drain Valve.....	26	Seat Retaining Nut.....	83	Stencil Kit, GT.....	31
Radiator Hose Set.....	24	Seat Side Molding.....	112	Stereo Adapter, Ipod/USB Flash.....	10
Radiator Insulator.....	25	Seat Stop Bumper Kit.....	112	Stone Deflector.....	144
Radiator Mounting Bracket.....	25	Seat Track Assembly.....	112	Stone Deflector Mounting Kit.....	82
Radiator Support.....	145	Seat Track Bolt.....	83	Stop Light Switch.....	14
Radiator Support To Hood Bumper.....	140	Seat Track Plate.....	112	Striker Assembly.....	40
Radiator Support To Hood Seal.....	140	Seat Track Spring Set.....	112	Stripe Kits.....	31 - 32
Radio.....	9 - 10	Sending Unit.....	73	Stripe Stencil, Hood.....	32
Radio and Heater Bezel Insert.....	98	Sequential Tail Lights.....	51	Strip Body Caulking.....	134
Radio Bezel.....	10, 91	Serated Flange Nut.....	82	Strut Rods.....	161
Radio Knob.....	10	Service Valve.....	86	Strut Rod Bracket.....	142, 160
Radio Knob and Dial Set.....	10, 91	Shackle Kit.....	159	Styled Steel Hub Cap.....	176
Radio Molding, Center Dash.....	98	Shaker Air Cleaner.....	59	Styled Steel Wheel.....	175
Rally Pac.....	109	Shaker Hood Trim Ring.....	147	Styled Steel Wheel Cover.....	176
Rally Pac Related.....	108 - 110	Sheet Metal & Body Parts.....	140	Sub Frame Connector.....	158
Ram Air Hood Seal.....	140	Shifter Assembly, Automatic.....	165	Suction Hose.....	87
Rear Cross Member.....	149	Shifter Boot.....	167	Sun Visor, Convertible.....	22, 106
Rear End Housing Nut And Washer Kit.....	83	Shifter Knob, Manual.....	166	Sun Visor, Coupe and Fastback.....	106
Rear End Lowering Kit.....	159	Shifter Mount Plate.....	168	Sun Visor Tip.....	107, 139
Rear End Vent Hose Kit.....	164	Shifter Selector Lever, Automatic.....	165	Surface Cleaner, AccuMatch™.....	131
Rear License Plate Dust Shield.....	136	Shifter Selector Lever, Manual.....	167	Surface Shine Sponge, AccuMatch™.....	131
Rear Seat Divider.....	172	Shifter Spring.....	83	Suspension.....	157
Rear Seat Hardware, Fastback.....	99	Shifter Trunnion.....	83	Sway Bar.....	161
Rear Spoiler.....	148	Shift Cover Screw.....	83	Sweatshirts.....	6
Rear Trim Center Cap, Fastback.....	100	Shift Indicator Light.....	47	T-Shirts.....	6 - 8
Rear Valance.....	149	Shock.....	160	T5 Conversion Kit.....	168
Rear Valance Mounting.....	82	Shock Access Hole Plug.....	139	Tach Dash Bracket, Shelby.....	110
Rear Vertical Glass Run Repair Kit.....	41, 137	Shock Tower.....	141 - 142	Tags.....	30 - 31
Rear View Mirror.....	106	Shock Tower Bolt.....	83	Tail Light 3 Bulb Inserts.....	51
Rear Wheel Bearing.....	13, 174	Shock Tower Brace.....	160	Tail Light Bezel.....	51 - 52
Rear Wheel Flare.....	147	Shock Tower Cap.....	142	Tail Light Filler Board.....	172
Rear Window Louver.....	148	Shock Tower Nut.....	83	Tail Light Honeycomb Panel.....	149
Rear Window Molding Kit.....	130	Shock Tower Patch, Inner.....	142	Tail Light Housing.....	52
Rear Window Seal.....	137	Side Marker Bezel, Light, Lens.....	50	Tail Light Housing Gasket.....	52, 136
Red Accent Light.....	47	Side Scoop, Shelby.....	148	Tail Light Housing Mounting Nut.....	52, 82
Reinforcement Pan, Convertible.....	141	Sight Glass Hose.....	87	Tail Light Housing Spacer.....	52
Relay, Horn.....	54	Sill Plate.....	98 - 99	Tail Light Housing To Body Seal.....	52, 136
Remote Control Mirror.....	128	Sill Plate Emblem.....	58, 99	Tail Light Lens.....	52
Return Spring Bracket.....	72	Smog Diverter Valve.....	67	Tail Light Lens Gasket.....	52, 136
Rev Limiter Repair Pigtail.....	54	Smog Ferrule and Nut.....	67	Tail Light Panel.....	149
Ring & Pinion.....	164	Smog Pump Belt.....	63	Tail Light Panel, LED.....	51
Road And Rally Light Kit.....	45	Smog Pump Filter.....	67	Tail Light Panel Bracket, Fastback.....	149
Rocker Molding.....	130	Smog Tubes.....	67	Tail Light Panel Emblem.....	57
Rocker Molding Emblem.....	57	Sound Deadener Kit.....	151	Tail Light Panel Molding.....	130
Rocker Panel.....	144	Spare Tire Cover.....	173	Tail Light Wiring Harness.....	52
Roll Bar.....	107	Spare Tire Mounting.....	172 - 173	Tension Rod Anti-Rattler.....	139
Roof Brace.....	148	Spare Tire Jack Pad.....	172	Thermostat.....	26
Roof Emblem.....	57	Spark Plug Wire Separator.....	62	Tie Rod.....	157
Roof Panel, Fastback.....	148	Speaker.....	11	Timing Chain Sets.....	62
Roof Rail Seal.....	137	Speaker Grille, Door.....	11, 39	Timing Cover.....	64
Rotor, Disc Brake.....	13	Speaker Grille, Rear.....	11	Timing Pointer.....	65
Rubber Grommet Kit.....	139	Speedometer Cable, Gears.....	168	Tire Pressure Gauge.....	4
Rubber Parts & Weather Stripping.....	135	Splash Shield.....	144	Tool Kit Bag.....	172
Seat, Flo-Fit Custom.....	118	Spoiler Gasket.....	136	Top Fender Hardware Kit.....	82
Seat Access Hole Plug.....	139	Sport Deck Bracket, Rear.....	100	Top Vent Rivet Tool.....	134
Seat Adjuster Knob.....	111	Sport Mirror Bezel Nut.....	128	Top Vent Seat Tool, Glass Run.....	134
Seat Back Adjusting Kit.....	112	Spray Adhesive.....	131	Top Vent Window Seal.....	40, 137
Seat Belt.....	110 - 111	Starter Bolt.....	79	Top Vent Window Seal.....	137
Seat Belt Anchor Plate.....	141	Starter Solenoid.....	54	Torque Box.....	142
Seat Bottom Frame.....	112	Steering.....	151	Traction Bar.....	161 - 162
Seat Button.....	112	Steering Box Rebuild Kit.....	154	Transition Pan.....	142
Seat Cushion.....	119	Steering Column, Tilt.....	153	Transmission & Drivetrain.....	162
Seat Hinge Cover.....	112	Steering Column Mounting.....	153	Transmission Cluster Gear.....	169

Transmission Countershaft Pin.....	169	Vent Grill, Fastback Interior.....	100	Windshield Washer Hose Kit.....	178
Transmission Crossmember Bar.....	168	Vent Seal Edge Rivet.....	40, 136	Windshield Washer Nozzle.....	179
Transmission Dip Stick.....	170	Vent Slide, Fastback.....	100	Windshield Washer Pump.....	179
Transmission Filter.....	170	Vent Window Bracket.....	40	Windshield Washer Reservoir.....	179
Transmission Flywheel.....	168	Vent Window Channel.....	40	Windshield Wiper Arm.....	179
Transmission Fulcrum.....	168	Vent Window Division Bar Seal.....	41, 137	Windshield Wiper Bezel and Nut Kit.....	179
Transmission Gear.....	169	Vent Window Frame.....	41	Windshield Wiper Blade.....	179
Transmission Mount.....	168	Vent Window Frame To Door Seal.....	41, 137	Windshield Wiper Pivot Seal.....	180
Transmission Oil Cooler Line.....	170	Vent Window Handle.....	41	Windshield Wiper Switch.....	180
Transmission Oil Line Bracket.....	170	Vent Window Seal.....	41, 137	Wipers.....	178
Transmission Pan.....	171	Vent Window To Door Seal.....	41, 138	Wiper Bezel Stem Nut Tool.....	91, 134, 180
Transmission Ring Gear.....	168	Vinyl Cleaner.....	131	Wiper Knob.....	91
Transmission Spacer Plate Conversion Kit.....	171	Vinyl Protectant.....	171	Wiper Motor Loom.....	47
Transmission Synchronizer.....	169	Vinyl Top.....	107	Wiper Switch Bezel.....	91
Trap Door, Fastback.....	100	Vinyl Top Molding.....	107, 130	Wiper Switch Spacer.....	91
Trim Adhesive Spray, Super.....	131	Voltage Regulator.....	55	Wiper Transmission Arm.....	180
Trip Reset Button Assembly.....	104	Voltage Regulator Mounting Kit.....	55, 79	Wire Harness Clip.....	55
Trunk & Fender Emblem.....	57	Voltage Regulator Screw Cap.....	55, 79	Wire Loom Mounting Kit.....	55
Trunk Brace, Convertible.....	149	Warning Buzzer, Headlight "On".....	45	Wire Spoke Center Cap.....	177
Trunk Bumper Brace.....	149	Washer Pump Pedal Pad.....	108, 139	Wire Spoke Wheel Cover.....	177
Trunk Carpet Kit.....	173	Watch.....	9	Wiring Diagram Manual.....	43, 124
Trunk Compartment.....	171	Water Bypass Hose.....	24	Wiring Loom Ties.....	79
Trunk Divider and Package shelf.....	149	Water Pump.....	24	Yoke.....	165
Trunk Filler Board.....	172	Water Temperature Sending Unit.....	27	Zerk Fitting.....	158
Trunk Floor.....	149	Water Valve Bracket.....	89		
Trunk Latch.....	122	Weatherstrip Adhesive.....	23, 131		
Trunk Lid.....	149	Weatherstrip Fastener.....	138		
Trunk Lid Bumper.....	136	Weather Stripping, Door.....	41		
Trunk Lid Fill Panel, Fastback.....	147	Weather Strip Adhesive.....	41		
Trunk Lid Hinge.....	150	Well Liner.....	23		
Trunk Lid Prop Rod.....	150	Well Liner Mounting Set.....	23		
Trunk Lid Striker.....	150	Well Liner Tensioning Spring.....	23		
Trunk Lock Cylinder.....	122	Wheels.....	174 - 175		
Trunk Lock Housing Spacer.....	122	Wheelhouse.....	150		
Trunk Lock Stem Extension.....	122	Wheel Beauty Ring.....	176		
Trunk Mat.....	173	Wheel Cover.....	176		
Trunk Molding.....	130	Wheel Grease Seal, Front.....	174		
Trunk Panel.....	150	Wheel Lock.....	174		
Trunk Release.....	173	Wheel Opening Molding.....	130		
Trunk Seal.....	136	Wheel Seal, Rear Axle.....	174		
Trunk Underlayment.....	174	Wheel Spacer.....	174		
Trunk Wheelhouse Seam Cover.....	137	Wheel Stud, Front Drum.....	13		
Turn Signal Switch.....	48	Windage Tray Bolt Kit.....	79		
U-Joint.....	165	Windlace.....	107		
Under-Dash Harness.....	47	Windows.....	177		
Under-Hood Stainless Trim.....	67	Window & Roofrail Seal Clip.....	41		
Undercoating.....	133	Window Channel Strip.....	42, 138		
Underhood Turn Signal Wiring Clips.....	55	Window Crank.....	35		
Underlayment Kit.....	93	Window Decals.....	33		
Under Hood Detailing Kit.....	79	Window Grommet.....	42		
Under Hood Seal Kit.....	140	Window Guide.....	83		
Upper Ball Joint Kit.....	158	Window Guide Bushing.....	42		
Upper Control Arm Shaft Kit.....	158	Window Regulator.....	42		
Upper Rear Trim Panel.....	100	Window Roller & Clip.....	42		
Vaccum Modulator.....	171	Window Sealer.....	41, 138		
Vacuum Canister.....	87	Windshield And Body Sealant.....	134		
Vacuum Line Hose Kit.....	62	Windshield filler panel.....	131		
Vacuum Modulator Line.....	63	Windshield Glass.....	177		
Valance To Frame Bracket.....	144	Windshield Molding.....	130		
Valve Cover.....	68	Windshield Pillar Molding, Convertible.....	131		
Valve Cover Bolt.....	79	Windshield Piller Pad.....	136		
Valve Cover Gasket.....	67	Windshield Seal.....	138		
Valve Cover Grommet.....	69	Windshield Sealant.....	134		
Valve Stem Seal.....	60	Windshield Sun Shade.....	6		
Vented Quarter Panel Trim, Fastback.....	100	Windshield Washer Bag.....	178		
Vent Glass.....	177	Windshield Washer Hose Connector.....	178		

**WE PROUDLY FEATURE AUTHENTIC MUSTANG
REPRODUCTIONS FROM SCOTT DRAKE ENTERPRISES!**





As a Scott Drake authorized dealer, we are proud to offer Mustang parts from the #1 name in Mustang restoration. Scott Drake is the world's largest manufacturer of reproduction parts for classic Mustangs, featuring over 8,000 quality products. And you can rest easy knowing each part is painstakingly designed, engineered and tested to ensure the best fit, durability and quality available.

Scott Drake Aluminum VALVE COVERS



See Page 68

- Fits all small block Fords (260, 289, 302, & 351W)
- Pressure die-cast from high-quality, 383-3 aluminum alloy
- Available with a powder-coated, wrinkle-texture finish or brightly polished aluminum finish
- Includes spark plug wire brackets, authentic rivets, PCV grommet and cadmium plated oil filler tube to help stop corrosion
- Improved oil baffle design clears most roller rockers*
- Also available: valve cover gaskets and mounting screws

Note: these will not fit EFI engines

Available in a variety of styles for different Ford models

289 POWERED BY FORD	SHELBY	<i>Fairlane</i> POWERED BY FORD
302 POWERED BY FORD	<i>Bronco</i> POWERED BY FORD	<i>Comet</i> POWERED BY FORD
351 POWERED BY FORD	<i>Ranchero</i> POWERED BY FORD	<i>Street Rod</i> POWERED BY FORD
MUSTANG* POWERED BY FORD	<i>Falcon</i> POWERED BY FORD	COUGAR
COBRA* POWERED BY FORD		

* Note: "MUSTANG" and "COBRA" versions will not clear roller rockers

The ultimate Mustang accessory... 1965-66 RALLY PACS



- Made by Scott Drake, these Rally Pacs are the best on the market
- Rally Pacs include all brackets and color coded wire harness
- Air-core movement tach and quartz movement clock
- Gauge faces feature the original style font for an authentic look
- Housing coated with a tough crinkle texture
- Available in a variety of popular, concours-correct colors
- Back lit for improved visibility at night
- Also available in an Electro-Luminescent "EL" version

See Page 109

Available in a variety of the most popular colors, to match your interior



Optional EL Version shown w/ the Scott Drake EL Instrument Panel

